

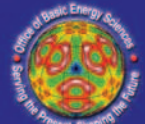

BASIC RESEARCH NEEDS FOR SUPERCONDUCTIVITY

Report of the Basic Energy Sciences
Workshop on Superconductivity,
May 8-11, 2006



On the Cover:

Superconductivity is one of nature's most exotic phenomenon; the complete loss of electrical resistance in certain materials when they are cooled to a low temperature. The loss-free circulation of superconducting currents also underlies key technological applications. For instance, intense magnetic fields are generated by coils of superconducting wires for medical magnetic resonance imaging. Only when cooled close to absolute zero of temperature (-273°C) do such metals and alloys become superconducting.

A revolution took place 20 years ago when entirely new families of superconductors based on ceramic oxides were discovered. These work at much higher temperatures. The current high-temperature superconductor $\text{HgBa}_2\text{Ca}_2\text{Cu}_3\text{O}_8$ is the record holder. It operates at temperatures as high as 164 K (-109°C). The crystal structure (on the front cover) of this complex oxide allows the electrical current to travel easily along certain crystal planes, which leads to superconductivity at these remarkably high temperatures.

Grand Challenges include the discovery of a room-temperature superconductor and unraveling its mechanism.

Diagram courtesy of Professor Peter P. Edwards and Dr. Martin O. Jones, Inorganic Chemistry Laboratory, Oxford University, England.

<http://www.chem.ox.ac.uk/researchguide/ppedwards.html>

BASIC RESEARCH NEEDS FOR SUPERCONDUCTIVITY

Report on the Basic Energy Sciences Workshop on Superconductivity

Chair: John Sarrao, Los Alamos National Laboratory
Co-chair: Wai-Kwong Kwok, Argonne National Laboratory

Panel Chairs:

Materials Ivan Bozovic, Brookhaven National Laboratory
Theory Igor Mazin, Naval Research Laboratory
Phenomena J.C. Seamus Davis, Cornell University
Leonardo Civale, Los Alamos National Laboratory
Applications David Christen, Oak Ridge National Laboratory

Office of Basic Energy

Sciences Contact: James Horwitz, Basic Energy Sciences, U.S. Department of Energy

Special Assistance

Technical: Gary Kellogg, Sandia National Laboratories
Douglas Finnemore, Ames Laboratory
George Crabtree, Argonne National Laboratory
Ulrich Welp, Argonne National Laboratory

Administrative: Christie Ashton, Basic Energy Sciences, U.S. Department of Energy
Brian Herndon, Oak Ridge Institute for Science and Education
Leslie Shapard, Oak Ridge Institute for Science and Education

Publication: Renée M. Nault, Argonne National Laboratory

This report is available on the web at http://www.sc.doe.gov/bes/reports/files/SC_rpt.pdf.

CONTENTS

Notation	v
Executive Summary	ix
Introduction.....	1
Broader Impact of Superconductivity	11
Grand Challenges.....	17
Reports of the Panels on Basic Research Needs for Superconductivity	25
Basic Research Challenges for Applications	27
Basic Research Challenges for Vortex Matter.....	43
Basic Research Challenges for Superconductivity Theory.....	61
Basic Research Challenges for New Phenomena	69
Basic Research Challenges in Superconducting Materials	85
Priority Research Directions	97
Pursue Directed Search and Discovery of New Superconductors	99
Control Structure and Properties of Superconductors Down to the Atomic Scale	103
Maximize Current-carrying Ability of Superconductors with Scalable Fabrication Techniques	109
Understand and Exploit Competing Electronic Phases.....	117
Develop a Comprehensive and Predictive Theory of Superconductivity and Superconductors	121
Identify the Essential Interactions that Give Rise to High T_c Superconductivity	125
Advance the Science of Vortex Matter.....	129
Cross-Cutting Research Directions.....	135
New Tools to Integrate Synthesis, Characterization, and Theory.....	137
Enabling Materials for Superconductor Utilization.....	141
Conclusion	145
Appendix 1: Current State of Research.....	151
Introduction and Overview	157
Superconducting Materials	160
Phenomenology of High Temperature & Exotic Superconductivity	171
Vortex Phenomena.....	183
Theory	193
Energy Related Applications for Superconductors.....	212
Appendix 2: Workshop Participants	221
Appendix 3: Workshop Program	227

NOTATION

ACRONYMS AND ABBREVIATIONS

1G	first generation
2-D	two-dimensional
2G	second generation
3-D	three-dimensional
AAO	anodic aluminum oxide
ac	alternating current
AFM	antiferromagnetic
Argonne	Argonne National Laboratory
ARPES	angle-resolved photoemission spectroscopy
BCS	Bardeen, Cooper, and Schrieffer
BES	Basic Energy Sciences
BSCCO	bismuth strontium calcium copper oxide
BZO	barium zirconate
CC	coated conductors
CNT	carbon nanotube
COBRA	coherent Bragg rod analysis
dc	direct current
DOE	U.S. Department of Energy
EIA	Energy Information Administration
EMF	electromagnetic field
F	field
fcc	face-centered cubic
FCL	fault current limiter
FIB	focused ion beam
FM	ferromagnetic
FWHM	full width at half maximum
GB	grain boundary
GDP	gross domestic product
GTO	gate-turnoff thyristor
H_{c2}	upper critical field of type II superconductor
HHV	higher heating value
HLPE	hybrid liquid phase epitaxy
HTEM	high-resolution transmission electron microscopy
HTS	high-temperature superconductor
IBAD	ion-beam-assisted deposition
IGBT	insulated-gate bipolar transistor
INS	inelastic neutron scattering
ISD	inclined-substrate deposition

J	current density
J_c	critical current density
J_e	engineering current density
LANL	Los Alamos National Laboratory
LBCO	lanthanum barium copper oxide
LNG	liquefied natural gas
LTS	low-temperature superconductor
LPE	liquid-phase epitaxy
MBE	molecular beam epitaxy
MFM	magnetic force microscopy
ML	monolayer
MOCVD	metal-organic chemical vapor deposition
MOD	metal-organic deposition
MOSFET	metal-oxide semiconductor field-effect transistor
MRI	magnetic resonance imaging
μ SR	muon-spin relaxation, rotation, or resonance
NAE	National Academy of Engineering
NIETC	National Interest Electric Transmission Corridor
NIST	National Institute of Standards and Technology
NMR	nuclear magnetic resonance
NQR	nuclear quadrupole resonance
NRC	National Research Council
NS	neutron scattering
O&M	operation and maintenance
OPIT	oxide-powder-in-tube
ORNL	Oak Ridge National Laboratory
PLD	pulsed laser deposition
PRD	priority research direction
PVD	physical vapor deposition
RABiTS	rolling-assisted biaxially textured substrate
R&D	research and development
RVB	resonating valence bond
SC	superconducting
SEM	scanning electron microscopy
SG	spin-glass
S-I-S	superconductor-insulator-superconductor
SI-STM	spectroscopic imaging-scanning tunneling microscopy
SNS	Spallation Neutron Source
SPI	Superconductivity Partnership Initiative
SQUID	superconducting quantum interference device
STM	scanning tunneling microscopy
STS	scanning tunneling spectroscopy

TAFF	thermally assisted flux flow
T	temperature
T_c	critical transition temperature
TEM	transmission electron microscopy
TMO	transition metal oxide
TVA	Tennessee Valley Authority
U.S.	United States
VAR	volt-ampere reactive power
YBCO	yttrium barium copper oxide
YSZ	yttrium-stabilized zirconia

UNITS OF MEASURE

A	ampere(s)
°C	degree(s) Celsius
cm	centimeter(s)
cm-w	centimeter(s)-width of tape
eV	electron-volt(s)
°F	degree(s) Fahrenheit
fs	femtosecond(s)
GHz	gigahertz
hp	horsepower
kA	kiloampere(s)
kA-m	kiloampere(s)-meter
kV	kilovolt(s)
kW	kilowatt(s)
kWh	kilowatt-hour(s)
K	Kelvin
m	meter(s)
mi	mile(s)
mm	millimeter(s)
MVA	megavolt(s)-ampere
MVAR	megavolt(s)-ampere reactive
MW	megawatt(s)
MW(e)	megawatt(s) (electric)
nm	nanometer(s)
s	second(s)
t	metric ton(s)
T	tesla
THz	terahertz
TW	terawatt(s)
TW-h	terawatt-hour(s)
VAR	volt(s)-ampere reactive
W	watt(s)
W_e	watt(s) (electric)
W_p	peak watt(s)
yr	year(s)

Å	angstrom(s)
\$	dollar(s)
µm	micrometer(s)
µs	microsecond(s)

EXECUTIVE SUMMARY

As an energy carrier, electricity has no rival with regard to its environmental cleanliness, flexibility in interfacing with multiple production sources and end uses, and efficiency of delivery. In fact, the electric power grid was named “the greatest engineering achievement of the 20th century” by the National Academy of Engineering. This grid, a technological marvel ingeniously knitted together from local networks growing out from cities and rural centers, may be the biggest and most complex artificial system ever built. However, the growing demand for electricity will soon challenge the grid beyond its capability, compromising its reliability through voltage fluctuations that crash digital electronics, brownouts that disable industrial processes and harm electrical equipment, and power failures like the North American blackout in 2003 and subsequent blackouts in London, Scandinavia, and Italy in the same year. The North American blackout affected 50 million people and caused approximately \$6 billion in economic damage over the four days of its duration.

Superconductivity offers powerful new opportunities for restoring the reliability of the power grid and increasing its capacity and efficiency. Superconductors are capable of carrying current without loss, making the parts of the grid they replace dramatically more efficient. Superconducting wires carry up to five times the current carried by copper wires that have the same cross section, thereby providing ample capacity for future expansion while requiring no increase in the number of overhead access lines or underground conduits. Their use is especially attractive in urban areas, where replacing copper with superconductors in power-saturated underground conduits avoids expensive new underground construction. Superconducting transformers cut the volume, weight, and losses of conventional transformers by a factor of two and do not require the contaminating and flammable transformer oils that violate urban safety codes. Unlike traditional grid technology, superconducting fault current limiters are smart. They increase their resistance abruptly in response to overcurrents from faults in the system, thus limiting the overcurrents and protecting the grid from damage. They react fast in both triggering and automatically resetting after the overload is cleared, providing a new, self-healing feature that enhances grid reliability. Superconducting reactive power regulators further enhance reliability by instantaneously adjusting reactive power for maximum efficiency and stability in a compact and economic package that is easily sited in urban grids. Not only do superconducting motors and generators cut losses, weight, and volume by a factor of two, but they are also much more tolerant of voltage sag, frequency instabilities, and reactive power fluctuations than their conventional counterparts.

The challenge facing the electricity grid to provide abundant, reliable power will soon grow to crisis proportions. Continuing urbanization remains the dominant historic demographic trend in the United States and in the world. By 2030, nearly 90% of the U.S. population will reside in cities and suburbs, where increasingly strict permitting requirements preclude bringing in additional overhead access lines, underground cables are saturated, and growth in power demand is highest. The power grid has never faced a challenge so great or so critical to our future productivity, economic growth, and quality of life. Incremental advances in existing grid technology are not capable of solving the urban power bottleneck. Revolutionary new solutions are needed — the kind that come only from superconductivity.

THE BASIC ENERGY SCIENCES WORKSHOP ON SUPERCONDUCTIVITY

The Basic Energy Sciences (BES) Workshop on Superconductivity examined the prospects for superconducting grid technology and its potential for significantly increasing grid capacity, reliability, and efficiency to meet the growing demand for electricity over the next century. The workshop brought together more than 100 leading scientists from universities, industry, and national laboratories in the United States, Europe, and Asia. Basic and applied scientists were generously represented, creating a

valuable and rare opportunity for mutual creative stimulation. Advance planning for the workshop involved two U.S. Department of Energy offices: the Office of Electricity Delivery and Energy Reliability, which manages research and development for superconducting technology, and the Office of Basic Energy Sciences, which manages basic research on superconductivity.

PERFORMANCE OF SUPERCONDUCTORS

The workshop participants found that superconducting technology for wires, power control, and power conversion had already passed the design and demonstration stages. The discovery of copper oxide superconductors in 1986 was a landmark event, bringing forth a new generation of superconducting materials with transition temperatures of 90 K or above, which allow cooling with inexpensive liquid nitrogen or mechanical cryocoolers. Cables, transformers, and rotating machines using first-generation (1G) wires based on $\text{Bi}_2\text{Sr}_2\text{Ca}_2\text{Cu}_3\text{O}_x$ allowed new design principles and performance standards to be established that enabled superconducting grid technology to compete favorably with traditional copper devices. The early 2000s saw a paradigm shift to second-generation (2G) wires based on $\text{YBa}_2\text{Cu}_3\text{O}_7$ that use a very different materials architecture; these have the potential for better performance over a larger operating range with respect to temperature and magnetic field. 2G wires have advanced rapidly; their current-carrying ability has increased by a factor of 10, and their usable length has increased to 300 meters, compared with only a few centimeters five years ago.

While 2G superconducting wires now considerably outperform copper wires in their capacity for and efficiency in transporting current, significant gaps in their performance improvements remain. The alternating-current (ac) losses in superconductors are a major source of heat generation and refrigeration costs; these costs decline significantly as the maximum lossless current-carrying capability increases. For the same operating current, a tenfold increase in the maximum current-carrying capability of the wire cuts the heat generated as a result of ac losses by the same factor of 10. For transporting current on the grid, an order-of-magnitude increase in current-carrying capability is needed to reduce the operational cost of superconducting lines and cables to competitive levels. Transformers, fault current limiters, and rotating machinery all contain coils of superconducting wire that create magnetic fields essential to their operation. 2G wires carry significantly less current in magnetic fields as small as 0.1 to 0.5 T, which are found in transformers and fault current limiters, and in fields of 3 to 5 T, which are needed for motors and generators. The fundamental factors that limit the current-carrying performance of 2G wires in magnetic fields must be understood and overcome to produce a five- to tenfold increase in their performance rating.

Increasing the current-carrying capability of superconductors requires blocking the motion of “Abrikosov vortices” — nanoscale tubes of magnetic flux that form spontaneously inside superconductors upon exposure to magnetic fields. Vortices are immobilized by artificial defects in the superconducting material that attract the vortices and pin them in place. To pin vortices effectively, an understanding not only of the pinning strength of individual defects for individual vortices but also of the collective effects of many defects interacting with many vortices is needed. The similarities of vortex pinning and flow to glacier flow around rock obstacles, avalanche flow in landslides, and earthquake motion at fault lines are reflected in the colloquial name “vortex matter.” To achieve a five- to tenfold increase in vortex pinning and current-carrying ability in superconductors, we must learn how to bridge the scientific gap separating the microscopic behavior of individual vortices and pinning sites in a superconductor from its macroscopic current-carrying ability.

COST OF SUPERCONDUCTORS

Although superconducting wires perform significantly better than copper wires in transmitting electricity, their cost is still too high. The cost of manufactured superconducting wires must be reduced by a factor of 10 to 100 to make them competitive with copper. Much of the manufacturing cost arises from the complex architecture of 2G wires, which are made up of a flexible metallic substrate (often of a magnetic material) on which up to seven additional layers must be sequentially deposited while a specific crystalline orientation is maintained from layer to layer. Significant advances in materials science are needed to simplify the architecture and the manufacturing process while maintaining crystalline orientation, flexibility, superconductor composition, and protection from excessive heat if there is an accidental loss of superconductivity.

Beyond their manufacturing cost, the operating cost of superconductors must be reduced. Copper wires require no active cooling to operate, while superconductors must be cooled to temperatures of between 50 and 77 K for most applications. The added cost of refrigeration is a significant factor in superconductor operating cost. Reducing refrigeration costs for future generations of superconducting applications is a major technology driver for the discovery or design of new superconducting materials with higher transition temperatures.

PHENOMENA OF SUPERCONDUCTIVITY

These achievements and challenges in superconducting technology are matched by equally promising achievements and challenges in the fundamental science of superconductivity. Since 1986, new materials discoveries have pushed the superconducting transition temperature in elements from 12 to 20 K (for Li under pressure), in heavy fermion compounds from 1.5 to 18.5 K (for PuCoGa₅), in noncuprate oxides from 13 to 30 K (for Ba_{1-x}K_xBiO₃), in binary borides from 6 to 40 K (for MgB₂), and in graphite intercalation compounds from 4.05 to 11.5 K (for CaC₆). In addition, superconductivity has been discovered for the first time in carbon compounds like boron-doped diamond (11 K) and fullerenes (up to 40 K for Cs₃C₆₀ under pressure), as well as in borocarbides (up to 16.5 K with metastable phases up to 23 K). We are finding that superconductivity, formerly thought to be a rare occurrence in special compounds, is a common behavior of correlated electrons or “electron matter” in materials. As of this writing, fully 55 elements display superconductivity at some combination of temperature and pressure; this number is up from 43 in 1986, an increase of 28%.

As the number and classes of materials displaying superconductivity have mushroomed, so also has the variety of pairing mechanisms and symmetries of superconductivity. The superconducting state is built of “Cooper pairs” — composite objects composed of two electrons bound by a pairing mechanism. The spatial relation of the charges in a pair is described by its pairing symmetry. Copper oxides are known to have d-wave pairing symmetry, in contrast to the s-wave pairing of conventional superconductors; Sr₂RuO₄ and certain organic superconductors appear to be p-wave. Superconductivity has been found close to magnetic order and can either compete against it or coexist with it, suggesting that spin plays a role in the pairing mechanism. Tantalizing glimpses of superconducting-like states at very high temperatures have been seen in the underdoped phase of yttrium barium copper oxide (YBCO), in the form of pseudogaps and of strong transverse electric fields induced by temperature gradients (the “vortex Nernst effect”) that typically imply vortex motion. The proliferation of new classes of superconducting materials; of record-breaking transition temperatures in the known classes of superconductors; of unconventional pairing mechanisms and symmetries of superconductivity; and of exotic, superconducting-like features well above the superconducting transition temperature all imply that superconducting electron matter is a far richer field than we suspected even 10 years ago.

While there are many fundamental puzzles in this profusion of intriguing effects, the central challenge with the biggest impact is to understand the mechanisms of high-temperature superconductivity. This is difficult precisely because the mechanisms are entangled with these anomalous normal state effects. Such effects are noticeably absent in the normal states of conventional superconductors. In the underdoped copper oxides (as in other complex oxides), there are many signs of highly correlated normal states, like the spontaneous formation of stripes and pseudogaps that exist above the superconducting transition temperature. They may be necessary precursors to the high-temperature superconducting state, or perhaps competitors, and it seems clear that an explanation of superconductivity will include these correlated normal states in the same framework. For two decades, theorists have struggled and failed to find a solution, even as experimentalists tantalize them with ever more fascinating anomalous features. The more than 50 superconducting compounds in the copper oxide family demonstrate that the mechanism of superconductivity is robust, and that it is likely to apply widely in nature among other complex metals with highly correlated normal states. Although finding the mechanism is frustratingly difficult, its value, once found, makes the struggle compelling.

RESEARCH DIRECTIONS

The BES Workshop on Superconductivity identified seven “priority research directions” and two “cross-cutting research directions” that capture the promise of revolutionary advances in superconductivity science and technology. The first seven directions set a course for research in superconductivity that will exploit the opportunities uncovered by the workshop panels in materials, phenomena, theory, and applications. These research directions extend the reach of superconductivity to higher transition temperatures and higher current-carrying capabilities, create new families of superconducting materials with novel nanoscale structures, establish fundamental principles for understanding the rich variety of superconducting behavior within a single framework, and develop tools and materials that enable new superconducting technology for the electric power grid that will dramatically improve its capacity, reliability, and efficiency for the coming century.

The seven priority research directions identified by the workshop take full advantage of the rapid advances in nanoscale science and technology of the last five years. Superconductivity is ultimately a nanoscale phenomenon. Its two composite building blocks — Cooper pairs mediating the superconducting state and Abrikosov vortices mediating its current-carrying ability — have dimensions ranging from a tenth of a nanometer to a hundred nanometers. Their nanoscale interactions among themselves and with structures of comparable size determine all of their superconducting properties. The continuing development of powerful nanofabrication techniques, by top-down lithography and bottom-up self-assembly, creates promising new horizons for designer superconducting materials with higher transition temperatures and current-carrying ability. Nanoscale characterization techniques with ever smaller spatial and temporal resolution — including aberration-corrected electron microscopy, nanofocused x-ray beams from high-intensity synchrotrons, scanning probe microscopy, and ultrafast x-ray laser spectroscopy — allow us to track the motion of a single vortex interacting with a single pinning defect or to observe Cooper pair making and pair breaking near a magnetic impurity atom. The numerical simulation of superconducting phenomena in confined geometries using computer clusters of a hundred or more nodes allows the interaction of Cooper pairs and Abrikosov vortices with nanoscale boundaries and architectures to be isolated. Understanding these nanoscale interactions with artificial boundaries enables the numerical design of functional superconductors. The promise of nanoscale fabrication, characterization, and simulation for advancing the fundamental science of superconductivity and rational design of functional superconducting materials for next-generation grid technology has never been higher.

A key outcome of the BES Workshop on Superconductivity has been a strong sense of optimism and awareness of the opportunity that spans the community of participants in the basic and applied sciences. In the last decade, enormous strides have been made in understanding the science of high-temperature superconductivity and exploiting it for electricity production, distribution, and use. The promise of developing a smart, self-healing grid based on superconductors that require no cooling is an inspiring “grand energy challenge” that drives the frontiers of basic science and applied technology. Meeting this 21st century challenge would rival the 20th century achievement of providing electricity for everyone at the flick of a switch. The seven priority and two cross-cutting research directions identified by the workshop participants offer the potential for achieving this challenge and creating a transformational impact on our electric power infrastructure.

INTRODUCTION

INTRODUCTION

The electric power grid looms large in America's energy future. It delivers clean energy at low cost and connects conveniently to many sources and end uses. For decades, the grid has been the invisible backbone of energy accessibility, enabling increases in productivity and quality of life with the flick of a switch. Although we seldom notice it, it ranks first on the list of great engineering achievements of the 20th century, according to the National Academy of Engineering. Yet this favored form of energy distribution is increasingly compromised by its limited capacity and reliability. By 2030, demand for electricity will grow by 50% in the United States and 100% globally. The power grid struggles to provide this increased capacity, especially in congested urban and suburban areas where demand is strongest and access for new power lines is tightest. Beyond capacity, the grid is effective only if it delivers energy reliably, keeping voltage and frequency tightly controlled within narrow windows. As we add more nodes to accommodate more generators and users, and as we send more power over the links connecting these nodes, we increase the potential for dynamic instabilities of voltage, current, and frequency. The sheer complexity of the electricity network precludes predicting these unstable modes in advance. Instead, we *discover* unstable behavior in the form of frequency fluctuations, overloaded transmission lines, brownouts, and blackouts. Some of these power failures can be stupendous, like the 2003 North American blackout that affected 50 million people and caused an estimated \$6 billion in economic losses. Remarkably, in the same year, additional blackouts in London, Scandinavia, and Italy occurred, some of which were of equivalent proportions. Such blackouts are caused by peak demand or an unexpected component failure that stresses the electricity delivery system; as power flows readjust, one failure triggers another and the cascade propagates to regional proportions within minutes.

POWER GRID DYNAMICS

Even in the absence of blackouts, the power grid is, effectively, "out of control." The grid has grown as a patchwork of local distribution systems, stitched together as they meet along their expansion frontiers. There are no designed routes for electricity flow; instead, the network enables a multiplicity of routes connecting generators and users. Electricity flow responds dynamically to the changing pattern of sources and users on the grid, mediated by the impedance of the connecting links. Electricity flows where it will, following the path of least resistance, in constantly changing patterns that instantaneously balance supply and demand. Active management of electricity flow is imposed only when a potentially dangerous condition is detected, such as low frequency or voltage due to insufficient generation, loss of synchronization between generators, or overload current in a particular line. The active responses to these conditions are to "shed load" by turning off service to blocks of customers, trip out generators to avoid damaging them, and trip out lines carrying overload currents. These active management responses can create new dangerous conditions that, in turn, trigger additional active responses. In the North American blackout of 2003, a cascade of active management responses tripped out 508 generators, spreading outages from Cleveland to Toronto to New York City within seven minutes.

Much of the existing grid reflects the technology of the 1950s through the 1970s, when local grids were smaller, simpler, and more isolated. Incremental increases in capacity using standard passive technology were sufficient to meet demand. Today's challenges are different. Higher complexity creates more instability; regional connectivity enables long-distance cascading blackouts; urban congestion limits access for additional power lines; and the profusion of digital electronics requires much tighter voltage control. Incremental improvements using traditional grid technology will not solve today's problems. Revolutionary new solutions that provide dramatically greater capacity, higher reliability, and tighter control of fluctuations are needed.

THE PROMISE OF SUPERCONDUCTIVITY

Superconductivity provides radically new solutions for increasing grid capacity and reliability, while dramatically improving efficiency as well. Transmission losses in the grid are substantial: 7% to 10% of the power delivered, equivalent to 40 power plants emitting 230 million metric tons of CO₂ per year. Superconductors carry direct current (dc) at no loss and alternating current (ac) at dramatically lower loss than copper wires. Replacing parts of the grid with superconducting overhead lines, underground cables, transformers, generators, and reactive power regulators can dramatically improve the grid's efficiency. Superconducting wires carry up to five times the current of copper wires that have the same cross section, providing expanded capacity in urban areas yet requiring no additional overhead lines or underground cables. Superconducting generators cut electrical generation losses in half, reduce volume and weight by a factor of two, and are stable against voltage and reactive power fluctuations. Superconducting transformers cut weight and footprint by a factor of two, cut losses by a factor of two, and use no contaminating or flammable cooling oil that could limit their use in urban areas. Superconducting fault current limiters are smart, fast switches that react abruptly to an overload current, limiting its magnitude and preventing damage to the grid; when the fault is cleared, they reset quickly, restoring the grid to full operating capacity. Superconducting reactive power regulators adjust the phase angle between voltage and current instantaneously over wide ranges, in compact, economical units that can be sited even in urban areas, providing smart correction of potentially dangerous conditions before they develop. Superconducting magnetic energy storage devices instantaneously reduce voltage fluctuations where clean power is needed; in addition, they have the potential to store large amounts of electrical energy for load leveling.

PROGRESS AND CHALLENGES

These benefits of superconducting grid technology are within reach. Since 1986, enormous strides have been made in discovering and developing materials that are superconducting above the temperature of boiling liquid nitrogen; designing scalable manufacturing routes that promote dual axis alignment and vortex pinning needed for high-current operation; and designing and demonstrating cables, transformers, fault current limiters, and rotating machines. First-generation (1G) superconducting wire based on bismuth strontium calcium copper oxide (BSCCO) has been surpassed by second-generation (2G) wire based on YBCO, with a radically different architecture and much higher performance potential. This paradigm shift in materials and design has enabled rapid progress in the last five years, increasing current-carrying capability by a factor of 10 and length by a factor of 1,000.

Despite this promising progress, significant gaps separate present technology from widespread market penetration. The high transition temperatures of the copper oxide family of superconductors dramatically relieve the refrigeration challenge, requiring cooling to only 77 K for zero applied magnetic field applications or 50 K for in-field applications, rather than 4 K as required by conventional superconductors. Nevertheless, refrigeration is still a major cost element, making discovery of new materials with even higher operating temperatures a technology driver. The current-carrying performance of 2G superconductors in zero applied magnetic field is barely adequate for applications like cables or fault current limiters. Doubling or tripling this performance would enable major reductions in the ac losses of cables, thus decreasing cryogenic costs. It also would enable a major reduction in the size and cost of fault current limiters. Performance drops significantly in fields of 0.1 to 3 T, required for transformers and rotating machinery. A five- to tenfold improvement in in-field current-carrying performance is needed. The architecture of 2G cables consists of up to seven different layers that must be laid down sequentially, often on a magnetic substrate and with the need to maintain crystalline orientation throughout the sequence. This complex architecture must be simplified and the manufacturing cost reduced by a factor of 10 to 100. Reaching this goal requires fundamental research on materials physics,

including simplified layer structures, and an understanding of texturing mechanisms, conductive buffer layers, and nonmagnetic substrates.

Beyond the promise of existing 2G superconducting technology, we can anticipate even more dramatic advances based on fundamentally new materials. To date, the copper oxide family of superconductors contains the only examples of transition temperatures above 77 K, the boiling point of liquid nitrogen. It would be a remarkable scientific oddity if there were no other materials with similar or higher superconducting transitions. The appearance of more than 50 compounds of different structure and composition within the copper oxide family demonstrates that high-temperature superconductivity is a common occurrence, rather than a singular event. Transition temperatures up to 164 K have been found under pressure in the HgBaCaCuO system, within a factor of two of 300 K, the nominal value of “room temperature,” where we distribute and use electricity. Experience with copper oxide superconductors teaches us that there is no fundamental limit to the superconducting transition temperature. Materials with higher transition temperatures are waiting to be found, perhaps with structures and compositions more complex and unusual than the copper oxides. The search for superconductors beyond the copper oxide family with transition temperatures that narrow or bridge the gap to room temperature is an inspiring, engaging, and profitable high-risk, high-payoff basic research challenge.

ELECTRON AND VORTEX MATTER

Bridging the gaps in practical superconductor performance requires not only empirical exploration of new materials and the factors affecting their performance but also a fundamental understanding of the microscopic origins of superconducting behavior. The two most important superconducting properties — transition temperature and current-carrying ability — arise from different aspects of the superconducting state, each with its own fundamental building blocks, interactions, and emergent macroscopic behavior. The superconducting state emerges at the transition temperature from interactions of electrons, first forming “Cooper pairs” of two electrons — the nanoscale building blocks of superconductivity. Cooper pairs further condense into the superconducting state, marked by macroscopic spatial coherence and an energy gap that stabilizes the resistanceless state against thermal fluctuations and electron scattering. Superconductivity and its transition temperature are emergent states of “electron matter,” the collection of free or loosely bound electrons in a solid and their interactions with each other and the outside world. Competing states of electron matter are metallic, insulating, semiconducting, magnetic, or ferroelectric. There is growing evidence that competition of superconductivity with these alternative states is an important factor in determining transition temperature.

In contrast to the transition temperature, the current-carrying ability of superconductors arises from the behavior of Abrikosov vortices, which are tiny tubes of magnetic flux surrounded by circulating supercurrents that form spontaneously upon the exposure of a practical superconductor to a magnetic field. Like Cooper pairs, vortices are nanoscale objects with dimensions ranging from a few tenths to hundreds of nanometers. Vortices repel each other, are attracted to “pinning sites” associated with defects in the superconductor, and vibrate randomly in response to the ambient temperature. These competing interactions create a rich variety of solid, liquid, and glassy phases of “vortex matter,” each with its own characteristic internal vortex structure, in close analogy with the familiar phases of ordinary atomic matter. An electric current exerts a force on vortices, causing them to move in complex dynamic patterns if the force is strong enough to dislodge them from their pinning sites. The threshold of motion for vortices defines the “critical current,” the maximum current a superconductor can carry without resistance.

Fundamental understanding of these twin cornerstones of superconductivity — (1) pairing and transition temperature arising from electron matter and (2) zero resistance and critical current arising from vortex

matter — has progressed enormously since 1986. For 30 years after their discovery in the 1950s, vortices were known only in their solid phase, and empirical methods to immobilize them by strong pinning accounted for their major research interest. Now we have discovered their first- and second-order melting transitions to a novel liquid phase, which occupies a far greater region of the phase diagram than the solid. We have described theoretically two kinds of glassy phases, one of them based on a new “columnar” pinning defect whose pinning strength is orders of magnitude larger than any previously known defect. We have developed new tools for tracking vortices, using scanning tunneling microscopy, Lorentz electron microscopy, scanning Hall probes, and magneto-optical imaging, that promise to reveal far more information about the static and dynamic behavior of vortices than could have been imagined in 1986. Along with new knowledge and new tools, our advances in fundamental understanding reveal new gaps separating us from promising new technologies. The vortex liquid phase that occupies the technologically attractive high-temperature region of the phase diagram cannot be pinned by the standard techniques for the vortex solid, because the viscosity of the liquid allows neighboring vortices to flow freely past each other. No longer can we rely on a few pins to immobilize many vortices. We must find qualitatively new strategies for pinning the vortex liquid if we are to benefit from its use in grid-connected superconductors.

Although discovery of higher-transition-temperature superconducting materials would be a major breakthrough for superconducting science and technology, there is one challenge that promises an even higher impact: understanding the mechanisms that drive Cooper pair formation and condensation of high-temperature superconductivity from electron matter. Two decades of intense scientific research have taught us much about the mechanisms of high-temperature superconductivity. The superconducting state comprises pairs of electrons as in conventional superconductors, but the pairing symmetry is d-wave rather than the conventional s-wave. The conventional electron-phonon mechanism cannot explain high-temperature superconductivity, but the proximity of nearby insulating magnetic states suggests spin interaction may be involved. The normal state from which superconductivity condenses is itself anomalous in its low-carrier density and unusual fluctuation spectrum. It forms mysterious ordered states with stripes and pseudogaps that are reminiscent of superconductivity but appear at much higher temperature. Despite these tantalizing clues to the origin of high-temperature superconductivity, we have not been able to crack nature’s code and penetrate the secrets of this fascinating behavior, though many scientists feel that we are near.

DISCOVERY VERSUS DESIGN

The variety of superconductors observed in copper oxides and other exotic materials (e.g., heavy fermions, organic metals, fullerides, Sr_2RuO_4 , diamond, and MgB_2) suggests there are many mechanisms for superconductivity, not just one. Understanding one or more of these mechanisms opens the door to a new paradigm in superconductivity: replacing serendipitous materials discovery with intentional materials design. One of the most remarkable features of superconductivity is the accidental discovery of nearly every new superconducting material, in the most unexpected places. Recent experience points to the copper oxides themselves (arguably the most dramatic, important, and unexpected materials discovery in all of superconductivity), to fullerides of the form A_3C_{60} , and to MgB_2 . The transition temperatures of all three materials shatter previous records for materials of their class and defy conventional wisdom. The continuing discovery of superconductivity in surprising places, and our frustrating inability to anticipate the next event, is one of the most enduring and engaging features of the field. The paradigm shift from discovery to design is already occurring for conventional electron-phonon superconductors. Modern calculations using density functional theory of the electronic structure of compounds and their coupling to phonon modes allows trends in the superconducting transition temperature in many compounds to be predicted. Unlocking the mechanisms of high-temperature superconductivity would open the door to designer superconductors, for which computer simulations point the way to real superconductors with predetermined properties. Bridging the paradigm gap from superconductors by serendipity to

superconductors by design is a landmark challenge in basic science with high impact for applied technology.

THE BASIC ENERGY SCIENCES WORKSHOP AND REPORT

As part of a broader initiative within the U.S. Department of Energy's (DOE's) Office of Basic Energy Sciences (BES) program to identify grand challenge science opportunities for energy security, as described in *Basic Research Needs to Assure a Secure Energy Future* (BES 2003), BES conducted a workshop and charged its participants to identify basic research needs and opportunities in all areas of superconductivity, with a focus on new, emerging, and scientifically challenging areas that have the potential to significantly affect science and energy-relevant technologies. It became clear at the workshop that bridging the science and technology gaps in superconductivity requires close coupling among materials synthesis, physical characterization, and functional utilization along a continuum that extends from fundamental science to real-world applications. Thus, while the present report is organized around applications, vortex matter, superconductivity theory, new phenomena, and superconducting materials, broader themes naturally cross cut and emerge. Indeed, a principal focus of the workshop was to identify the small number of priority research directions that span these approaches and possess the greatest likelihood of driving qualitative and revolutionary breakthroughs for understanding and utilizing superconductivity.

The opening plenary session set the stage for the workshop, as Patricia Dehmer, Director of DOE's Office of Basic Energy Sciences, explained the workshop charge and the role of electricity in the larger energy context. John Sarrao and Wai-Kwong Kwok, workshop co-chairs, presented the workshop's organizational structure, composed of panels dealing with materials, phenomena, theory, and applications. Plenary speakers Paul Chu, Alex Malozemoff, George Crabtree, Z.X. Shen, and Mike Norman provided an overview of superconducting science and technology, followed by a summary of DOE technology programs presented by James Daley, Program Manager for Superconductivity in DOE's Office of Electricity Delivery and Energy Reliability

Panel Chairs Ivan Bozovic (materials), J.C. Seamus Davis (phenomena), Igor Mazin (theory), and David Christen (applications) addressed the opening plenary session to set the stage for the work of their panel and subpanel breakout sessions on each thematic area. Each breakout session featured invited speakers presenting issues and provoking lively, free-flowing discussion on the grand challenges in the field and promising research directions to achieve them. These insights and new ideas were correlated across panels and distilled down to their essence, and then the panel chairs presented them as a whole in the closing plenary session. This report presents the collective wisdom and vision of the workshop through five panel surveys of the status and future prospects for applications, vortex matter, superconductivity theory, new phenomena, and superconducting materials. The focus of the report and the primary output of the workshop are the seven priority research directions and two cross-cutting research directions that outline the most promising and exciting research opportunities for revolutionary breakthroughs advancing the science and technology of superconductivity.

The remainder of this report is organized as follows. Below is a capsule summary of five organizational themes: applications, vortex matter, superconductivity theory, new phenomena, and superconducting materials. More complete descriptions of the current status and science challenges associated with these themes are found in the panel surveys that follow. The next sections present the priority research directions identified by the workshop. These represent the main output of the workshop and set a course for basic and applied research in superconductivity for the coming years. The priority research directions are followed by cross-cutting research directions that support more than one theme and connect broadly

with research beyond superconductivity. The conclusion presents a brief summary of the most important workshop findings.

Applications. Fundamental research in superconductivity has an important role to play in establishing an efficient, reliable, and secure electrical distribution system to meet the rapidly growing demand for electricity and decrease the number of large-scale and local blackouts and power fluctuations that currently result in billions of dollars in lost revenues annually. Demand for electricity in the United States grows at a rate of about 2.3% per year. The fraction of total energy consumed in the form of electricity is expected to rise from 40% to 70% by 2050, and it may be dramatically higher if electric-powered vehicles permeate our society in the future. The physical properties of superconductors could facilitate revolutionary advances in power transmission and distribution. By using the pathways provided by the present copper conduits of the electric grid, superconducting cables could transmit electricity at up to five times the existing capacity, easily meeting the demands of the next century. Furthermore, the resistive response of superconductors to overload currents enables the design and development of novel devices that can react quickly and dynamically to load disruptions. New complementary superconducting power equipment, such as fault current limiters, transformers, and reactive power generators, will be compact and operate with higher capacity than conventional equipment.

Since the discovery of high-temperature superconductors, novel wire development techniques have advanced rapidly, partly in response to advances in sophisticated physical and chemical deposition systems. The techniques have allowed flexible wires to be manufactured out of brittle ceramic materials. Wire prototypes have been developed as a result of recent research in which some major barriers to practical electric transmission in these ceramic superconducting compounds — such as weak grain boundaries and low ductility — have largely been overcome. 2G wires are currently being developed, the performance of which will vastly exceed that of 1G wires. These projects are a mere beginning, but they are already poised to exploit superconductivity phenomena to improve the urban distribution of electricity through increased capacity and load-leveling machinery. Basic research driving the discovery of new superconductors with higher transition temperatures and current-carrying capacity will provide the seeds for revolutionary advances in solving the electric distribution needs of the 21st century.

Vortex matter. This is the bridge that connects basic-science-driven discoveries with use-inspired basic research and has a fundamental impact on all practical superconductivity applications. Vortices in superconducting materials are nanoscale magnetic flux tubes, created by circulating supercurrents. Vortices permeate all practical superconductors when they are subjected to significant magnetic fields and whenever a current flows. The static and dynamic behavior of these vortices directly affects the current-carrying capacity of the superconductor. The deceptively simple electrostatics of a single vortex belies the dynamical complexity of an ensemble of vortices responding to their mutual repulsive magnetic interactions and simultaneous attractive interactions to defects in the materials that immobilize or “pin” them. The “pinning” of vortices by materials defects can be critical in obtaining “zero-resistance” superconducting current flow in practical applications. Describing the emergent behavior of complex

BES, 2003, *Basic Research Needs to Assure a Secure Energy Future, A Report from the Basic Energy Sciences Advisory Committee*, prepared by Oak Ridge National Laboratory for the U.S. Department of Energy, Office of Basic Energy Sciences (Feb. 2003); available at http://www.sc.doe.gov/bes/reports/files/SEF_rpt.pdf.

G. Constable and B. Somerville, *A Century of Innovation: Twenty Engineering Achievements That Transformed Our Lives* (2003); available at <http://www.greatachievements.org/>.

U.S.-Canada Power Systems Outage Task Force, *Final Report on the August 14, 2003 Blackout in the United States and Canada: Causes and Recommendations* (April 2004); available at <https://reports.energy.gov/>.

systems, such as the system of vortices and defects, is a fundamental challenge touching many areas of science. Analogies between the rich static and dynamic behavior of vortices in superconductors and that of atoms in ordinary solids and liquids justify the name *vortex matter*. Vortex matter exhibits many of the characteristics of ordinary solids. Like atomic solids, vortex “solids” come in a variety of ordered and disordered solid phases and can “melt” at high temperatures into liquid states, just as ice melts into water. The importance of the vortex state concept was recognized by the 2003 Nobel Prize awarded to Alexei Abrikosov for his theoretical prediction of the existence of superconducting vortices.

The problem of vortex pinning and optimization of the electromagnetic and transport properties of superconductors by incorporating artificial structural defects is one of the central issues that spans fundamental discovery science and use-inspired studies of high-temperature superconductors. The outcome of such studies could determine the ultimate current-carrying capacity of a superconductor and hence the ultimate performance of superconducting electrical equipment.

Superconductivity theory. Theoretical understanding of superconducting pairing mechanisms in different classes of superconductors will guide the choice of materials to synthesize, eventually leading to the capability to predict whether newly designed bulk materials and nano-architected structures will be superconducting. Recent fundamental advances in first-principle calculations and related developments in the theory of strongly correlated materials allow for an accurate prediction of the electronic structure of complex materials, with the assistance of highly enhanced computational power. Once a pairing mechanism is understood, based on many-body theory, numerical models are developed to predict superconducting transition temperatures for specific materials. This methodology has been successfully applied to a variety of new superconductors, most notably MgB_2 , one of the most promising of the noncuprate superconductors. These emerging first steps toward the rational design of new superconductors will provide new directions for the grand challenge search for room-temperature superconductors, as well as materials with improved capacity to carry large currents with high critical magnetic fields.

Some of the most interesting classes of superconductors, including but not limited to the high-critical-transition-temperature (T_c) cuprates, are characterized by particularly strong interactions between the electrons, leading to qualitatively new physical effects. Unconventional superconductivity is but one of them. Starting from the work of Drude in the early 1900s and later developments by Sommerfeld, Fermi, Landau, and others, the theory of electrons in metals was built upon the idea that the mobile electrons move as nearly free particles, weakly interacting with the ions and each other. The new paradigm, developed especially in the last 20 years since the discovery of high- T_c superconductivity, is that in some metals such “free particles” simply do not exist, and the collective behavior of the electrons has to be considered in its full complexity. The charge and spin excitations of the electrons in such systems may become decoupled from each other, resulting in qualitatively different transport and magnetic properties. New phases of matter can arise, and novel effects (unconventional superconductivity being one of them) often emerge near the associated phase boundaries. Understanding the behavior of such “strange metals” is one of the biggest challenges that the materials community is facing now. Although much progress has been made in this field in the last 10 years, we still have a way to go before achieving a proper microscopic understanding of strongly correlated electron systems. Part of this grand challenge will be to construct the theory of high-temperature cuprate superconductivity.

New phenomena. Like many other discoveries of fundamental physical phenomena, the discovery of high-temperature superconductivity has driven research in new directions. It has inspired new ideas, piqued the interest of bright minds, and served as the engine for driving new areas of commercial technology. Recently, advances in probing the mystery behind the mechanism of high-temperature

superconductors have resulted in the discovery of several new “competing” magnetic or charge-ordered phases within the superconducting phase, which share many commonalities with other known and new “exotic” superconductors. In addition to perhaps holding the key to the mechanism of high-temperature superconductivity, these “competing order” phases may promote new approaches for manipulating the superconducting state.

The investigation of these exotic phenomena has led to the development of a powerful arsenal of new experimental tools and to vast improvements in existing tools for probing the charge and spin states of electrons. They include angle-resolved photoemission spectroscopy (ARPES), complementary spectroscopic imaging-scanning tunneling microscopy (SI-STM), and a collection of spectroscopy tools that span the entire spectrum from microwave through optical frequencies and are designed to map out the complete momentum space, real space energy quantum states, and dynamic interactions of electrons. In addition to these powerful “electron” probes, magnetic probes — such as resonant and inelastic x-ray spectroscopy; neutron scattering probes; and magnetic, nuclear quadrupole, and muon spin spectroscopy tools (i.e., nuclear magnetic resonance [NMR], nuclear quadrupole resonance [NQR], and muon spin relaxation [μ SR]) — provide information on the spin structure and dynamics of the material.

These new techniques have allowed spectacular fundamental advances, such as the detection of d-wave superconducting gaps, discovery of novel spin/charge “stripe” phases, and observation of nanoscale “checkerboard” electronic states in the vortex cores of the cuprate high-temperature superconductors, to name just a few. The rapid pace of discovery points to an even more scientifically fruitful future. Integrating the suite of techniques in a coordinated way will, for the first time, allow a comprehensive mapping of the electronic and magnetic properties of materials that will be sufficient to reveal how they function. This ambitious endeavor will be a huge undertaking, rivaling the biological “genome” mapping and astrophysical “sky surveys” in data volume and complexity. The results will have an enormous impact on the design and on our understanding of new materials, including the higher-temperature superconductors that are critical to helping meet the energy transmission and distribution needs of the United States.

Superconducting materials. The recent discovery of novel systems — such as the two-band superconductor MgB_2 with a T_c as high as 40 K, doped fullerenes A_xC_{60} with a T_c of 33 K, and exotic superconductivity in the heavy fermion superconductor PuCoGa_5 with a T_c of 18.5 K (which is an order of magnitude higher than previously reported for this type of superconductor) — suggests the ubiquity of superconductivity, which was once considered a rare phenomenon. Moreover, the discovery of high- T_c superconductivity in the cuprates has demonstrated that superconductivity is no longer a low-temperature phenomenon. Unlike earlier theoretical predictions, present theories suggest no barriers to higher transition temperatures. These discoveries serve as springboards for the search for new superconducting materials. This search is bolstered by new synthesis and doping techniques that enable crystal growth in extreme environments, rapid combinatorial search methods, and precision atomic-layer engineering. Sophisticated doping techniques, such as field-effect doping, which induces no chemical disorder, open new horizons for tunable doping in a single sample. A strong synergy between materials synthesis, characterization, theory, and computation will be needed to achieve success in the quest for new, ultra-high-temperature superconductors.

BROADER IMPACT OF SUPERCONDUCTIVITY

BROADER IMPACT OF SUPERCONDUCTIVITY

Superconductivity has been on the frontier of innovation in science and technology since its beginning. Following quickly on the heels of the first-ever liquefaction of helium, the discovery of superconductivity in 1911 dramatically demonstrated the fascinating and unexpected behavior of materials near absolute zero. Mapping the occurrence of superconductivity in the periodic table pushed the frontiers of discovery science and experimental technique in early low-temperature physics. Since the 1920s, when the advent of quantum mechanics provided the needed theoretical framework, the challenge of explaining superconductivity has captured the imagination of the best minds in science, including Einstein, Bohr, Feynman, and Landau.

The theoretical breakthrough came in 1957, when Bardeen, Cooper, and Schrieffer (BCS) announced their revolutionary formulation. The superconducting state is difficult to understand because it requires an intricate dance of all the electrons in a solid, each correlating its motion not just with nearest neighbors, but with as many as 10,000 other electrons. This highly correlated superconducting state cannot be derived from the normal electron state by increments. The entire dance appears all at once; the electron troupe breaks up into pairs, and each pair executes intricately choreographed motions that range over the entire stage, without ever bumping another pair of dancers.

The remarkable success of BCS theory and the experiments it stimulated have reshaped our understanding of solids. This theoretical framework, including its description of the behavior of electrons in the normal metallic state before pairing sets in, has become a cornerstone of our understanding of solids. The subtle interplay of electrons and their environment gives rise to remarkable and completely unexpected quantum phenomena. These highly correlated states of “electron matter” illustrate nature’s beauty and the reason why superconductivity holds a special place in physics.

BCS theory demonstrated two concepts that have enormous influence in science. The first is nonincremental (or “nonperturbative”) many-particle states. The highly correlated superconducting state is a qualitatively new feature that cannot be derived mathematically as a continuous perturbation of the normal metallic state. Instead, the superconducting state is an emergent phenomenon, requiring a new many-body wave function that must be discovered by intuition rather than derived from a parent state. Nonperturbative emergent states, first demonstrated by BCS, are now basic to condensed matter science and our understanding of superfluidity, heavy fermion metals, antiferromagnetism, and the quantum Hall effect.

BCS demonstrated a second influential concept: spontaneous symmetry breaking. In symmetry-breaking transitions, a new symmetry element, like a preferred direction in space, suddenly appears, even though nothing in the system, such as a gravitational or magnetic field, favors its appearance. Spontaneous symmetry breaking defies common sense because there is no apparent cause or origin for the appearance of the new symmetry element. The BCS state spontaneously breaks the gauge symmetry of electrodynamics, giving rise to the Meissner exclusion of magnetic fields. Spontaneous symmetry breaking borrowed from BCS is a dominant feature of relativistic quantum field theory, where it is responsible for the mass of certain elementary particles in the standard model and for the appearance of the strong, weak, and electromagnetic forces in the early universe.

Beyond demonstrating concepts, the BCS formulation of pairing is applied commonly to nuclear matter, giving rise to energy gaps and excitations in nuclei and in neutron stars. Pairing of neutrons produces neutral superfluids; pairing of protons produces superconductors.

Bednorz and Muller's 1986 discovery of cuprate superconductivity was a revolutionary challenge to the foundations of our understanding of quantum phenomena in solids, and especially, a challenge to superconductivity. The award of the Nobel Prize to Bednorz and Muller in 1987, only one year after their discovery, affirmed the high value the scientific community placed on this breakthrough, which liberated minds from conventional wisdom. While we do not yet know the mechanisms of high-temperature superconductivity, we do know that they are richer, more powerful, and more subtle than those of conventional highly correlated states. The origin of high-temperature superconductivity is a premier grand challenge of modern science, and it attracts the best minds to struggle with its solution. These bright minds create insights and new pathways in their search for explanations, which serve as a major source of innovation for condensed matter science.

Superconductivity drives the frontiers not only of theory, but also of materials synthesis and experimental science. The discovery of high-temperature superconductivity in the complex oxides triggered extensive investigation of the other properties of this remarkable class of materials. The replacement of Cu by Mn produces an abundance of novel magnetic phases where the behavior of spins is intimately linked to the behavior of charges and crystal structures. The complex oxides contain metals, semiconductors, magnets, ferroelectrics, and superconductors in the same or nearly the same structures, opening the door to a host of multifunctional materials combinations. The surprising discovery of superconductivity in MgB_2 sparked a drive to synthesize other compounds of light elements in search for superconductivity, and the mapping of borocarbide superconductivity led to the discovery of new magnetic effects. Superconducting fullerides like Cs_3C_{60} and CaC_6 suggest that some forms of carbon nanotubes may hold surprising correlated electron behavior. We are realizing that complexity enables functionality; developing this concept occupies a premier place on the intellectual agenda of the 21st century.

The drive to characterize superconductors has fundamentally transformed the landscape of condensed matter experiments. Sophisticated techniques, such as angle-resolved photoemission spectroscopy (ARPES), have risen to the challenge of mapping the Fermi surfaces and energy gaps of high-temperature superconductors with dramatic breakthroughs in their energy resolution. Likewise, scanning probe spectroscopy and microscopy, neutron and x-ray absorption, and ground state property measurements have been advanced and perfected in ways considered impossible before the discovery of high-temperature superconductivity. These experimental techniques have not only advanced our understanding of superconductivity but have also enabled many discoveries in other materials systems and scientific disciplines. These advances attract large numbers of talented young people into physical science, an important component of our national scientific competitiveness. Looking toward the future, superconductivity will continue to drive the parallel development of experimental techniques, innovative materials synthesis, and creative theoretical formulations. The impact on the larger intellectual agenda will be enormous, as these tools are applied for testing new ideas, discovering surprises, and challenging orthodoxies.

Further reading:

F. Wilczek, "In Search of Symmetry Lost," *Nature* **433**, 239 (2005).

NOBEL PRIZES FOR SUPERCONDUCTIVITY

Superconductivity is a remarkable emergent behavior that has intrigued great minds since its discovery in 1911 by Heike Kamerlingh-Onnes. Kamerlingh-Onnes found that in a tiny temperature interval between 4.1 and 4.2 K, the electrical resistance of mercury dropped precipitously by 22 orders of magnitude to a true zero value within measurement capacity. The stunning discovery of loss-free electrical flow brought about new ways of thinking about both the materials in which superconductivity occurs and the processes that occur when electrons flow through a conductor. For this discovery and the liquefaction of helium, among other things, Kamerlingh-Onnes won the 1913 Nobel Prize in physics.



After the discovery of superconductivity, it took 40 years and considerable development of the quantum mechanical theory of solids to arrive at a theoretical explanation of the phenomenon. In 1957, John Bardeen, Leon Cooper, and Robert Schrieffer (BCS) showed that the zero-resistance state resulted from the condensation of electrons into a highly correlated state composed of Cooper pairs, binding two electrons through creation and exchange of *phonons*, the quantized vibrational motions of the atoms in the solid. The resulting correlated electron motion extends over thousands of atomic lattice spacings. Furthermore, many Cooper pairs overlap and cooperate to produce a rigidity in the highly correlated motion among enormous numbers of electrons, which Bardeen called a *macromolecule*. Superconductivity can be viewed as a macroscopic manifestation of quantum mechanics. It turns out that the exchange not only of phonons, but also of other types of quantum particles, can act as the “glue” for the electron pairs. For these ideas of electron pairing and highly correlated motion among the electrons, which became known as the “BCS theory,” Bardeen, Cooper, and Schrieffer won the Nobel Prize in 1972.

A free electron can be described as a wavefunction consisting of an amplitude and a phase to describe where it is located and how it moves. Since the condensed electron pairs in the superconducting state are highly correlated, they can, in the absence of a current, be described by a single wavefunction. Using this “phase-coherent” idea of the Cooper pairs, Brian Josephson showed that there is a relationship between the phase of the electrons and an applied voltage. If two pieces of superconductor are separated by a very thin insulating barrier, then a small number of paired electrons will “tunnel” through this barrier in a highly correlated manner, essentially leading to current flow without a voltage to drive it! Josephson also predicted that if a direct-current (dc) voltage was applied to this superconductor-insulator-superconductor (S-I-S) sandwich, it would create a time-varying change in the phase of the electrons across the barrier, leading to the *spontaneous* flow of an alternating current (ac). The ac frequency is determined by the applied voltage. The inverse process also works: A high-frequency current through the junction will generate a voltage proportional to the frequency. This frequency-to-voltage conversion process is currently used as the international standard for defining the volt and also as a way to measure voltages and magnetic fields that are 1,000 times smaller than can be measured with conventional electronics. For their experimental work with superconducting transport through thin insulating barriers and the theoretical work describing the phase and amplitude of superconducting current, Esaki, Giaever, and Josephson won the Nobel Prize in 1973.

In the early days, superconductivity was thought to occur solely in elemental metals and intermetallic compounds in which there are plenty of free electrons. The superconducting transition temperatures of these materials were relatively low, and the highest remained at a plateau of about 23 K (−418°F) for over a decade. The revolutionary discovery of superconductivity at 36 K in ceramic conducting copper oxide materials in 1986 was followed a few months later by the discovery of superconductivity at 90 K and 120 K in structurally related materials. The search for superconductivity in nontraditional materials eventually led to greater understanding of the forces controlling the binding of atoms into solids and to studies of complex organic materials and conducting oxides. It opened whole new ways of thinking about chemical bonding, as well as new models for the conduction process in doped insulators and marginal conductors. For their important breakthrough in the discovery of superconductivity in ceramic materials, Bednorz and Muller won the Nobel Prize in 1987.

Many of the conceptual surprises and seemingly odd properties of superconductors arise because the highly correlated motion of the electrons enables the effects of quantum mechanics to be seen on a macroscopic scale. For practical applications, perhaps the most important of these macroscopic quantum mechanical effects is the existence of vortices — magnetic flux tubes formed by circulating superconducting electrons, creating a single quantum of flux. When applied to a type II superconductor (all technologically important superconductors belong to this class), a magnetic field causes the condensed electrons to respond as a unit and expel all the magnetic flux for low magnetic fields in the so-called *Meissner effect*. At higher fields, however, the magnetic flux enters the superconductor in the form of *discrete* magnetic flux tubes called vortices, which usually form a triangular array of well-separated tubes. These vortices each contain one single quantum of flux equivalent to $\Phi_0 = 2.07 \times 10^{-15} \text{ Tm}^2$. Practical superconductors contain a dense array of tiny quanta of magnetic flux with a spacing of approximately 20 nm at a field of 5 T. When a current is applied to such a superconductor, each of these flux quanta moves. This moving flux will, by Faraday’s law, create a voltage across the superconductor, resulting in nonzero resistance and power dissipation. The importance of the superconducting vortex state was

NOBEL PRIZES FOR SUPERCONDUCTIVITY (CONT.)

recognized in 2003, when Alexei Abrikosov received the Nobel Prize for his prediction of vortex structure. Abrikosov shared the prize with Vitaly Ginzburg for his pioneering work on the powerful phenomenological formulation of superconductors and with Anthony Leggett for his work on superfluid helium-3 (^3He).

Superconductivity has already contributed greatly to technological progress. Magnetic resonance imaging (MRI) facilities using superconducting magnets are now commonplace. Cell phone towers around the world collectively employ more than 6,000 superconducting filter systems. Superconducting quantum interference devices (SQUIDs) provide one of the most sensitive means for detecting magnetic fields. High-temperature superconducting wires are poised to enhance the performance and reliability of the electric power grid. Nevertheless, there is one challenge that promises even higher impact: understanding the mechanisms that drive Cooper pair formation and electron condensation in high-temperature superconductors. Success in this endeavor could provide the "tipping point" for the move from the serendipitous search for new superconductors to their discovery by design. An accepted theory of high-temperature superconductivity will likely result in a Nobel Prize, if and when such a theory emerges.

GRAND CHALLENGES

GRAND CHALLENGES

Superconductivity is on the verge of creating historic transformational opportunities for technology and science. These opportunities offer four grand challenges that, if met, would transform the capacity, reliability, and efficiency of the electric power grid and open new frontiers for the science of superconductivity and complex materials. Although the four grand challenges are stated separately for technology and science, they share many of the same innovative pathways in their pursuit of the ultimate goals: performance and functionality for technology and knowledge and understanding for science. In the spirit of Pasteur, the synergistic pursuit of all four goals is enormously more productive than pursuing any one alone.

TRANSFORM THE POWER GRID TO DELIVER ABUNDANT, RELIABLE, HIGH-QUALITY POWER FOR THE 21ST CENTURY

Technologically we have the materials, engineering designs, and prototypes for high-capacity cables that could transport electricity at no loss for smart power-control devices (e.g., transformers, fault current limiters, and reactive power generators); these could cut the devices' size, weight, and energy losses in half and regulate them at higher performance levels. Technology also exists for energy conversion devices (e.g., motors and generators) that are half the size and weight of their conventional counterparts and can handle fluctuations in voltage and reactive power much more effectively. This superconducting technology, if deployed widely, could transform the power grid to achieve much higher capacity and efficiency in urban areas, where need and cost are greatest, and restore its reliability through smart instantaneous control that is beyond the reach of conventional technology. Although present superconducting technology provides proof of principle and can be deployed for some of the grid functions, significant barriers remain to achieving the full potential of superconductivity for transforming the power grid. These remaining barriers are related to performance, cost, and materials, which are considered separately below.

Performance Barrier

State-of-the-art second-generation (2G) superconducting wires based on $\text{YBa}_2\text{Cu}_3\text{O}_7$ are capable of carrying five times the current of copper wires having the same cross section at dramatically higher efficiency. While their performance competes favorably with copper for transporting current, it falls significantly in the magnetic fields required for transformers, fault current limiters, reactive power generators, and motors.

Challenge. The current-carrying performance of superconducting wires in magnetic fields of 0.1 to 5 T must be increased by a factor of 5 to 10. Current-carrying performance is determined by the ability of artificial defects in superconductors to immobilize or pin superconducting vortices carrying magnetic flux. Achieving the required increase in current performance requires fundamental advances in our understanding of the effects of the size and morphology of specific individual defects on pinning effectiveness, the summation effects of many defects of many kinds interacting with many vortices, and the nature of the de-pinning transition at the onset of vortex motion. Advances are needed in nanoscale fabrication and characterization techniques to create specific pinning landscapes, image their full three-dimensional (3-D) structures, and monitor their failure modes at the de-pinning transition.

Cost Barrier

While the benefits of superconducting technology for the power grid are legion, their costs are too high to compete with conventional technology. A major contributor to the cost of manufacturing 2G wires is their multilayered architecture, which requires sequential deposition of up to seven layers on a flexible metal substrate while epitaxial alignment between layers is maintained.

Challenge. The cost of superconductors must be reduced by a factor of 10 to 100 to compete with conventional technology. The materials and architecture of 2G wires must be simplified to enable lower manufacturing cost without sacrificing performance. Achieving this cost reduction will require innovative materials science to find materials and deposition processes that achieve the fundamental goals of epitaxial orientation, preventing compositional contamination of the superconductor, and protecting against thermal damage in the event of an accidental loss of superconductivity.

Materials Barrier

Improved superconducting materials have enabled the dramatic progress in superconducting technology over the past two decades. First-generation (1G) wires based on $\text{Bi}_2\text{Sr}_2\text{Ca}_2\text{Cu}_3\text{O}_{14}$ brought the operating temperatures to 77 K for transporting current and to ~ 30 K for in-field applications. 2G wires based on $\text{YBa}_2\text{Cu}_3\text{O}_7$ maintain the operating temperature of 77 K for transporting current and raise the operating temperature for in-field applications to 50 K. Although these improvements in operating temperature are critical enablers for today's superconducting technology, they are small when considered in light of the highest known transition temperatures and the operating temperature of the grid, which is room temperature. The copper oxides already produce superconductivity at 164 K in HgBaCaCuO under pressure, which is within a factor of two of room temperature. Current-carrying performance is governed by vortex pinning strength, which depends fundamentally on the intrinsic anisotropy of the superconducting state. The increased current-carrying potential of 2G wire over 1G wire is due to an order-of-magnitude or more reduction in its intrinsic anisotropy. Breakthrough superconducting materials for technology need much higher transition temperatures and lower intrinsic anisotropies. Although these two challenges can be pursued independently, their impacts are related. Higher operating temperatures tend to lower current-carrying ability through thermal de-pinning, vortex creep, and the loss of shear rigidity in the vortex liquid state. Lower intrinsic anisotropy strengthens pinning, reduces vortex creep, and shifts the onset of the liquid state to higher temperature. Thus, lower intrinsic anisotropy may be a necessary corollary to higher transition temperature if significant benefits are to be achieved.

Challenge. We need to find new superconducting materials with higher transition and operating temperatures in order to reduce operating costs, and with lower intrinsic anisotropies in order to raise current-carrying ability. The ultimate materials challenge is to find a room-temperature superconductor with no intrinsic anisotropy. Nothing in our experience with high-temperature superconductivity indicates that this challenge is beyond the limits of possibility.

PREDICT AND CONTROL THE ELECTROMAGNETIC BEHAVIOR OF SUPERCONDUCTORS FROM THEIR MICROSCOPIC VORTEX AND PINNING BEHAVIOR

Despite the fundamental importance of macroscopic properties with regard to the basic science and applications of superconductors, we have remarkably little knowledge about how these properties (e.g., lossless current-carrying ability, resistance in the lossy state, and response to alternating currents and magnetic fields) emerge from the microscopic behavior of vortices. The corresponding challenge for

atomic matter would be, for example, to predict the macroscopic behavior of ice (e.g., its rigidity, elastic limit, fracture pattern and plastic flow in response to a shear force, melting temperature, and viscosity in the liquid state) from the microscopic behavior of its composite water molecules. The challenge for vortices is compounded by the presence of a forest of pinning sites permeating the vortex array and affecting most of its properties. While the macroscopic emergence of vortex matter is rich in providing fascinating challenges (approximately equivalent to those of atomic matter), a few stand out as being particularly important. We should be able to predict the maximum lossless current and the resistance for lossy current flow for a given landscape of diverse, interacting pinning sites. We should understand why we rarely achieve more than 10–20% of the theoretical maximum lossless current, even though simple estimates based on the strength of individual pinning sites predict achieving 100%. We should understand the novel pinning mechanisms for two-band vortices, like those in MgB_2 , and embedded magnetic pinning sites. Next-generation superconductors operating at higher temperatures will use the vortex liquid state for applications in which replacing the rigidity of the solid by the viscosity of the liquid demands entirely new pinning paradigms. The dynamic behavior of the vortex liquid and its response to point and columnar pins and to planar “dams” should be explored.

Challenge. We need to understand the emergence of the macroscopic properties of vortex matter (e.g., lossless current-carrying ability and resistance in the lossy state) from the microscopic behavior of an array of vortices in a realistic landscape of diverse, interacting pinning sites. Interesting cases include vortex solid and liquid phases, unconventional vortices like two-band vortices in MgB_2 and highly anisotropic vortices in bismuth strontium calcium copper oxide (BSCCO), and pinning by commensurate and incommensurate landscapes of points, columns, and planes.

ACHIEVE A PARADIGM SHIFT FROM MATERIALS BY SERENDIPITY TO MATERIALS BY DESIGN

Since the beginning of their history in 1911, superconductors have been discovered by serendipity, not by prediction from fundamental principles. The initial discovery of superconductivity in mercury was especially surprising, since even the existence of the effect was unexpected at the time. For decades, superconductivity was thought to be a rare occurrence in materials, known in only 26 elements and less than 175 alloys and compounds by 1963.¹ The pace of discovery ramped up sharply in the 1980s, not only in the spectacularly fertile copper oxides, but also in the non-copper-oxides, organics, carbides, fullerides, borides, heavy fermions, borocarbides, and the elements. We began to look seriously at ternary and quaternary compounds, which dramatically increase the number of candidates and their potential complexity. Since 1986, the number of known superconducting elements has grown from 43 to 55, with a top transition temperature of 20 K for Li under pressure. Transition temperatures in compounds have risen dramatically, in heavy fermions from 1.5 to 18.5 K, in borides to 40 K for MgB_2 , and in fullerides to 40 K for Cs_3C_{60} under pressure. The most interesting discoveries are the highest transition temperatures, for the clues they provide on the mechanism and the empirical insight they offer for the next increase in transition temperature. Despite our knowledge of more than 50 high-temperature superconducting compounds among the copper oxides, however, the fact remains that we cannot predict where the next increase will occur. We now understand that superconductivity is a common occurrence among materials, not the exception it was once thought to be. Despite our greater experience with many more superconductors of very different kinds, however, we still do not know how to predict the occurrence of superconductivity or design a material with given superconducting properties. It is becoming increasingly clear that superconductivity may arise from multiple mechanisms, as indicated by the s-wave pairing in conventional superconductors, the d-wave pairing of copper oxides, and the p-wave pairing of Sr_2RuO_4 .

¹ B.T. Matthias, T.H. Geballe, and V.B. Compton, “Superconductivity,” *Rev. Mod. Phys.* **35**, 1 (1963).

The situation is reminiscent of particle physics before the standard model, when the proliferation of elementary particles seemed bewildering.

Challenge. Establish the “family tree” of superconductivity by identifying new classes of superconductors and isolating the factors promoting the occurrence of superconductivity in each class, with special emphasis on finding a room-temperature superconductor. Meeting this challenge requires extending the search for superconductivity to new materials, including ternary, quaternary, and higher order compounds with increasingly complex structures. We must exploit our empirical intuition for where superconductors are likely to be found, such as near phase boundaries with localized states like insulators, magnets, and ferroelectrics; in materials with many interacting orbital and structural degrees of freedom, including charge and spin; and in materials with competing ordered states.² The overwhelming challenge in establishing the family tree of superconductivity is to discover new superconducting materials with a higher transition temperature, as experience shows that systematic investigations of new superconducting behavior quickly follow discovery.

DISCOVER THE MECHANISMS OF HIGH-TEMPERATURE SUPERCONDUCTIVITY

The revolutionary formulation and overwhelming success of Bardeen, Cooper, and Schrieffer (BCS) theory in explaining conventional superconductors demonstrate the subtlety and importance of electronic correlation for superconductivity. We are now finding that highly correlated electronic behavior occurs even in the normal state of complex materials. It is fairly common in the complex oxides, with colossal magnetoresistance and a profusion of coupled-magnetic, charge-ordered orbital and structural transitions. In the underdoped normal state of $\text{YBa}_2\text{Cu}_3\text{O}_{7-\delta}$, we see antiferromagnetic-insulator, spin-glass, pseudogap, self-organized-stripe, and quantum critical states, all indicative of highly correlated electrons. The consensus is emerging that these highly correlated normal states are precursors for high-temperature superconductivity, although the connection is far from clear. The inescapable conclusion is that superconductivity is only one of many kinds of highly correlated electron behavior. Although superconductivity is the first example of highly correlated electronic behavior to be understood microscopically (for conventional superconductors, by BCS theory), that is only the “tip of the iceberg.” In complex materials with many interacting degrees of freedom, we may expect condensation to highly correlated electronic states that are not superconducting, like the two-dimensional (2-D) Laughlin states in the quantum Hall effect. These states may compete with, or complement, superconductivity. In either case, it seems clear that the mechanism of high-temperature superconductivity is intimately bound up with highly correlated normal states. Our increasing knowledge of correlated normal state behavior is an important element in solving high-temperature superconductivity.

Challenge. We need to understand the mechanism of high-temperature superconductivity and its relationship to the highly correlated normal states of complex materials. Meeting this challenge requires us to obtain new systematic knowledge of superconducting and normal-state behavior in new complex superconductors and to creatively explore pairing mechanisms and modes of correlation in superconducting states.

The mechanism of high-temperature superconductivity is a defining challenge in condensed matter physics. It embodies the major trends in materials science, including studies of materials of increasing complexity, the interaction of many degrees of freedom, competition of opposing ordered states, highly

² R. Hott, R. Kleiner, T. Wolf, and G. Zwicknagl, “Superconducting Materials — A Topical Overview,” pp. 1–70 in *Frontiers in Superconducting Materials*, A.V. Narlikar, Ed., Springer, Berlin, Germany (2005).

correlated normal and superconducting states, and the emergence of simple behavior from complex origins. Understanding the mechanism of high-temperature superconductivity is the ultimate link in the paradigm shift from discovering superconductors by serendipity to discovering them by design. Knowing the mechanism may allow us to not only find naturally occurring superconductors but also design new superconducting materials with specific properties by using the tools of nanoscale science and technology. Specific layer sequences in the complex oxides, for example, could allow pairing to occur in one layer, charge doping to be contributed from another, and vortex pinning to come from a third, all in sufficiently close proximity to be effective and with continuous tunability of transition temperature and current-carrying ability. Such superconducting materials by design would revolutionize the way we think about superconductivity.

These four grand challenges — transforming the power grid for the 21st century, understanding the macroscopic electrodynamic behavior of superconductors from microscopic vortex and pinning interactions, charting the family tree of superconductivity, and finding the mechanism of high-temperature superconductivity — are strongly synergistic. Improving the current-carrying ability of practical superconductors illuminates the connection between microscopic vortex and pin site interactions and macroscopic electrostatics, and raising the transition temperature for applications charts the family tree of superconducting materials. Achieving the paradigm shift from superconductors by serendipity to superconductors by design would significantly accelerate the development of superconducting technology for transforming the power grid.

The synergy between the scientific and technological grand challenges illustrates the fundamental connection between discovery science and use-inspired basic research. The most important advances often contribute equally to both. Finding a room-temperature superconductor, for example, would contend strongly for a Nobel Prize in physics and at the same time open new horizons for technology. Taken together, the four grand challenges capture this dual-use functionality. They embody the spirit of Pasteur in contributing equally to science and technology, and they exemplify the concept and appeal of research in Pasteur's Quadrant.³

The four grand challenges map onto the workshop panel themes of materials, phenomena, theory, and applications, representing the highest-level aspirations in each area. The priority research directions and cross-cutting research directions chosen by the workshop participants support the grand challenges, showing the directions that must be pursued if the grand challenges are to be achieved. The priority and cross-cutting research directions are the pathways that lead to the grand challenges, and, like the best dual-use research, they often support two or more grand challenges.

³ D.E. Stokes, *Pasteur's Quadrant: Basic Science and Technological Innovation*, Brookings Institution Press, Washington, D.C. (1997).

PANEL SURVEYS

Basic Research Challenges for Applications	27
Basic Research Challenges for Vortex Matter	43
Basic Research Challenges for Superconductivity Theory	61
Basic Research Challenges for New Phenomena	69
Basic Research Challenges in Superconducting Materials.....	85

BASIC RESEARCH CHALLENGES FOR APPLICATIONS

In the decade following the discovery of high-temperature superconductors (HTSs) in 1986, extensive international research led to the fabrication of HTS materials with a range of critical transition temperatures (T_c 's) above the boiling point of liquid nitrogen, as well as to broad phenomenological understanding of their properties. These materials have been pursued for a variety of technologies, but the strongest driver has been the electric power utility sector. Electric power transmission through HTS power cables offers the chance to reclaim some of the power lost in the grid, while also increasing capacity by several times. Use of HTS conductors could also improve high-current devices, especially in terms of efficiency, capacity, and reliability. By the mid-1990s, despite many formidable technical problems, researchers had begun to realize viable first-generation (1G) HTS conductor technologies based on $\text{Bi}_2\text{Sr}_2\text{Ca}_2\text{Cu}_3\text{O}_{14}$ (BSCCO), which make available conductors that are suitable for engineering demonstration projects and for first-level applications in real power systems. Second-generation (2G) HTS conductors based on $\text{YBa}_2\text{Cu}_3\text{O}_7$ (YBCO) are currently poised to replace BSCCO, which will dramatically improve performance while also lowering costs.

Today we have a much broader view of the potential benefits that superconductivity could provide to our nation and society. Deregulation of utilities initiated through the 1992 Energy Policy Act created the electricity marketplace, which is now in a position to strongly influence the nation's economy, given sufficient capacity in the electric power grid. An analogy may be drawn to the state of communications and digital information prior to the implementation of high-capacity fiber-optic networks; as we now know, the *global* economy has been transformed by the availability of an almost unlimited capacity to transfer information. As a society, we must not ignore the possibilities for economic growth if the ability to transfer enormous amounts of electric power was attained. Moreover, electricity demand in the United States continues to grow at a rate of about 2.3% per year, tracking closely with the overall growth of the economy (gross domestic product [GDP]). The fraction of total energy consumed in the form of electricity also has steadily increased, to about 40% at present, and is poised to go as high as 70% by 2050. Thus, it is predicted that electricity will become *the* major commodity form of energy. Clearly, technologies that provide enormous capacity and the ability to control it will be of central importance to our nation's economy and security. Superconductivity is one such technology.

We also now see more clearly what materials improvements are needed to encompass the full range of power applications and create a comprehensive revolution in how electric power is generated, distributed, and used in the United States. This vision, in turn, defines a critical set of use-inspired basic research challenges that need to be addressed in order to ensure and even accelerate this revolution. In this section, the motivation for and status of this thrust are outlined, including a brief description of the advances that have contributed to the present HTS power conductors.

BACKGROUND

Superconductivity in the Future Electric Grid

Constraints on the availability of inexpensive electric power were a central issue taken up by the 2005 Energy Policy Act. Electricity transmission capacity is being added through National Interest Electric Transmission Corridor (NIETC) provisions for rights of way. New advanced transmission line technologies will be deployed in present and future overhead transmission corridors to increase their power capacity effectively threefold. An integral part of the Energy Policy Act is the U.S. Department of Energy's (DOE's) monitoring of geographic areas that experience electrical transmission capacity constraints or congestion that adversely affects consumers. New corridors will be assigned according to

the criteria of supply, economic need, limitations on new electricity sources, improved diversification of supply, and support of energy independence.

A second key part of the Energy Policy Act is its support for new technologies that can increase capacity, efficiency, flexibility, and reliability. The biggest challenge facing the power grid is the deeply rooted historical trend to urbanization in the United States and the world. Neither the dominance of this trend nor its impact on the power grid can be overestimated. The percentage of the U.S. population in urban areas will grow to nearly 90% of all U.S. residents by 2030, up from 60% in 1950. This dramatic demographic shift augurs future challenges that the present power grid is not equipped to handle. Cities and suburbs are becoming increasingly stringent in the environmental, safety, and aesthetic limits they place on power access corridors, to the point that obtaining permits for new overhead power lines and underground cables takes years at a minimum and may ultimately be impossible. The growing complexity of urban power networks increases the magnitude and danger of fault currents, straining the limit of present technology. Plug-in hybrids that use electricity from the grid for transportation may intensify demand in urban areas, where the major use of cars is for commuting.

Superconducting technology promises to relieve this urban power bottleneck. Replacing conventional overhead lines and underground cables with superconductors could provide up to five times more capacity for congested areas, avoiding the costs and permitting delays associated with building new power corridors. Superconducting lines and cables carry the same power at dramatically lower voltages than their conventional counterparts, reducing or eliminating one of the biggest barriers to municipal permitting. Underground superconducting cables produce no heat, and their coaxial design generates no stray magnetic fields, so they do not disturb surrounding underground infrastructure. Superconducting fault current limiters not only handle higher fault currents than do conventional limiters, they also trigger and reset automatically and much more quickly. The footprint of superconducting transformers, generators, and reactive power regulators is half the size of the footprint of conventional technology, and superconducting transformers use no contaminating or flammable oils that restrict their use in urban settings. Beyond these structural and performance benefits, superconducting technology cuts energy losses in the grid by a factor of two or more; this will have the most impact in urban areas, where power demand and density are highest.

The superconducting solution to urban power bottlenecks is not just compelling, but critical. Incremental improvements in conventional grid technology cannot increase its capacity by a factor of five without new construction; cannot cut energy losses in half; cannot provide smart, fast response to large fault currents; and cannot reduce urban permitting restrictions on transformers. Without these advances, continuing urbanization and demand for electricity as our preferred energy carrier will overwhelm the power grid in urban areas.

The key aspects of superconducting cable and grid technology are summarized below.

Superconducting Transmission Cables. An HTS power cable (Figure 1) is a flat-conductor-based transmission line that carries large amounts of electrical current. Liquid nitrogen flows through the cable, cooling the HTS conductor to a zero-resistance state. The cable's most useful property is its compaction of large electrical currents into a small conductor area, which in technical terms is referred to as high electrical current density. Within the superconducting layer of the new 2G superconductors, current densities are typically more than 10,000 times higher than those possible in copper. When support for liquid nitrogen and other materials is included, both 1G and 2G HTS power cable technologies could provide about a fivefold increase in power capacity over that of a copper cable.

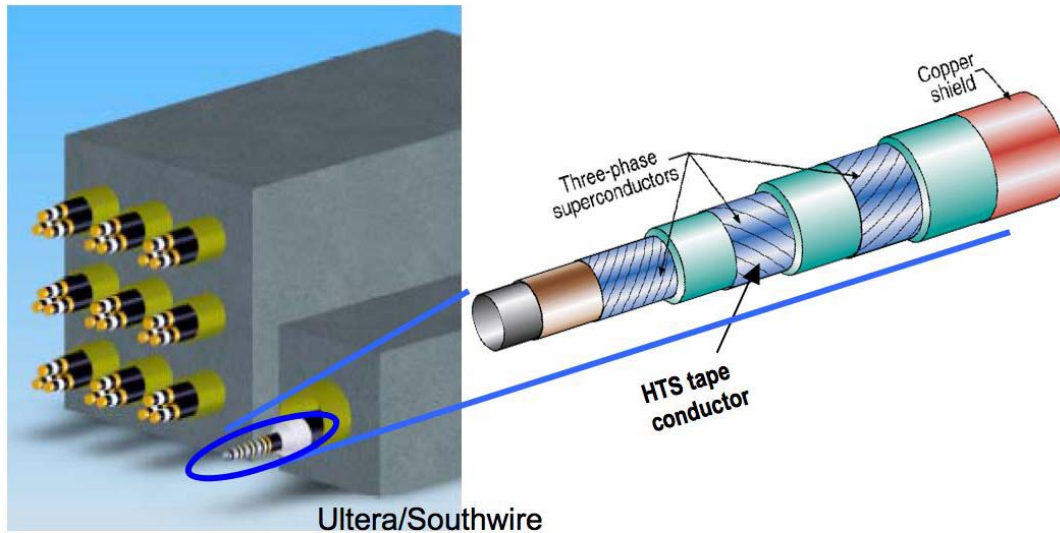

Figure 1 Schematic comparison of the 3×3 duct bank of an underground copper distribution system vs. a single triaxial HTS cable operating at 13 kV and transferring 69 MVA of power.

HTS transmission cables confer many potential benefits, including these:

- Retrofit power conduits in urban settings and at critical interconnections, where the cost of replacing infrastructure is prohibitive;
- Eliminate the need for new rights of way;
- Enable power flow at low voltages, significantly reducing permitting requirements;
- Replace overhead transmission lines with underground conduits to address environmental, security, and other concerns;
- Eliminate thermal and electromagnetic field (EMF) disturbance to surrounding underground infrastructure;
- Enhance overall system efficiency as a result of exceptionally low losses;
- Increase reliability by eliminating faults from vegetation, lightning, etc.;
- Enable direct control of power flow in combination with phase angle regulators;
- Increase utility system operating capacity and flexibility; and
- Reduce electricity costs via intracontinental power marketing.

Another benefit of superconductivity lies in its ability to possibly transport energy on a scale of many gigawatts to terawatts from remote generation facilities (e.g., wellhead and mine-head generation at gas and coal fields and nuclear power-plant clusters) over distances of several hundred kilometers. Only the high current-carrying ability of superconductors can enable this. Within the present grid, excess power available in California cannot be piped to meet higher demand in New England. High current-capacity transmission based on superconductivity could enable actual diurnal trading of electric power on an intracontinental scale.

Demonstration HTS Cable Projects. Despite their relative infancy, HTS cables are beginning to demonstrate benefits to the utility industry by relieving constraints on infrastructure. It is estimated that 80,000 mi of Cu-based power cables lie in underground conduits throughout the world to transmit large amounts of power to congested urban areas. Because the existing conduit size limits the amount of power that can be transmitted through them, increasing the power supply to urban areas carries with it a tremendous cost for adding conduit infrastructure.

One aboveground facility — a 30-m-long, three-phase, 12.5-kV system that uses a 1G conductor — has been operating since February 2000, providing 100% of the load for operating the Southwire Company plant in Carrollton, Georgia. Building on this success, three new projects, transporting underground power for “real-world” demonstrations, are under way and scheduled for completion no later than 2007. The new projects are located at Holbrook substation, Long Island Power Authority, Long Island, New York (610 m long); Bixby substation, American Electric Power Company, Columbus, Ohio (200 m long); and to link the Riverside and Menands substations, Niagara Mohawk Power Company, Albany, New York (350 m long).

Superconducting Transformers. Transformers convert generation-level voltage to high transmission-level voltages, reducing the amount of energy lost in the transmission of power over long distances. Transformers are also needed to convert the voltage back to a distribution level. Small, quiet, lightweight, and efficient HTS transformers will be used primarily at substations within the utility grid. Environmentally friendly and oil-free, they will be particularly useful where transformers previously could not be sited, such as in high-density urban areas or inside buildings. Significant energy losses occur in conventional transformers as a result of the iron in the core (no-load losses) and the copper in the windings (load losses).

HTS Fault Current Limiters (FCLs). A current limiter is designed to react to and absorb unanticipated power disturbances in the utility grid, preventing loss of power to customers or damage to utility grid equipment. FCLs would be installed in transmission and distribution systems for electric utilities and large energy users in high-density areas. The benefits include increased safety, increased reliability, improved power quality, compatibility with existing protection devices, greater system flexibility from adjustable maximum allowed current, and reduced capital investment because of deferred upgrades. The superconducting FCL provides the same continuous protection, with no standby energy losses due to joule heating and no voltage drop. The superconducting FCL instantaneously limits the flow of excessive current by allowing itself to exceed its superconducting transition temperature and switch to a purely resistive state, thus minimizing the fault current that passes through it.

The potential for damage from fault currents and the necessity to protect against them is a major challenge for urban areas. As more generators are added to the network to accommodate greater demand, the maximum fault current that can flow in the network if there is an accidental short circuit increases. The size of these potential fault currents eventually reaches the limit of conventional breaker technology, approximately 60,000 A, a limit that some urban areas are already approaching. Reaching the maximum fault current limit creates a major challenge that will inevitably occur in many regions, since it is driven only by adding generating capacity to the grid in high-power-density areas. Superconductivity, as it does with regard to the challenge of capacity, provides a simple and effective solution.

Superconducting Rotating Machinery

Superconducting Motors. Superconducting motors employ HTS windings in place of conventional copper coils. Because HTS wire can carry significantly larger currents, these windings are capable of generating correspondingly stronger magnetic fields in a given volume of space. A superconducting motor with one-third the size and weight can match the power output of an equally rated conventional motor. Because of savings in materials and labor, HTS motors will cost less to manufacture than their conventional counterparts. Their smaller size will also enable them to be manufactured and shipped directly to the customer, without costly disassembly and subsequent on-site reassembly and testing.

Large electric motors consume approximately 30% of the electricity generated in the United States. Although these motors are more than 90% efficient, even a 1% improvement integrated over national consumption would result in energy savings approaching a billion dollars. The zero-resistance coils in superconducting motors cut electrical losses in half. Furthermore, HTS alternating-current (ac) synchronous motors have no iron teeth in their armatures (stator windings), resulting not only in a smaller size and lighter weight but also in reduced motor noise. HTS motors will compete in the market for large (1,000 hp and above) commercial motors for use in pumps, fans, compressors, blowers, and belt drives deployed by utility and industrial customers, particularly those requiring continuous operation. Another use for HTS motors is in naval and commercial ship propulsion, where HTS motors can reduce size and weight, increase design flexibility, and open up limited space for use.

HTS Generators. The primary application of superconducting generators will be utility generation facilities using either new or retrofitted generators. By using superconducting wire for the field windings, designers can practically eliminate losses in the rotor windings and armature bars. Furthermore, the fields created in the armature by the rotor are not limited by the saturation characteristics of iron. As is the case for superconducting motors, the armatures are constructed without iron teeth, thereby removing another source of energy loss. An HTS generator will be one-third the overall volume of its conventional equivalent. In power plants where expansion is difficult (e.g., shipboard or locomotive power), superconducting generators can increase generating capacity without using additional space. Smaller, lighter HTS generators use an “air core” design, eliminating much of the structural and magnetic steel of a conventional equivalent; construction, shipping, and installation are all simplified and less costly. HTS generators have lower armature reactance, which can profoundly affect utility stability considerations. One implication is a reduction in the amount of spinning reserve (unused but rotating generating capacity) needed to ensure a stable overall power system. Also, an HTS generator has the capability of being significantly overexcited to permit power factor correction without adding synchronous reactors or capacitors to the power system.

Reactive Power Generators. These devices operate somewhat like a motor or generator without a real power source and either provide or absorb reactive power needed to keep the voltage and current in phase. An industrially funded 8-MVAR machine produced by American Superconductor Corporation has been tested for a year on the Tennessee Valley Authority (TVA) grid, and TVA has ordered the first two 12-MVAR commercial units, which are under construction. Thus, the reactive power generator is the first commercial power equipment based on HTS wire. In the future, these devices could be essential in assuring power stability. The U.S.-Canada Task Force examining the North American blackout of 2003 identified the lack of reactive power as the principal contributing factor to the cascading power outage. As the grid becomes more complex in order to accommodate more demand with more generators, the need for smart reactive power control increases. Substantial deployment of intermittent renewable energy technologies (e.g., solar, wind, and wave power) could introduce additional instabilities into the grid.

Superconducting reactive power generators can provide active regulation of reactive power in a small, economical package.

CURRENT STATUS

Cuprate Conductors

HTS conductors typically take the form of a thin tape that can be bent around relatively small diameters into high-density coil windings. The first viable HTS conductor viable for power applications was the bismuth-based superconductor, BSCCO. BSCCO wire is a multifilamentary composite superconductor that includes individual superconducting filaments (running the length of the conductor) encased in a high-purity silver or silver-alloy matrix material (~60% of the wire volume is silver or silver alloy). These wires are formed by loading a powder of BSCCO into the silver or silver-alloy tube, which is then sealed and drawn into a fine wire. These segments are cut and re-stacked for a series of additional drawing, rolling, and heat-treatment steps, leading to the final multifilament oxide-powder-in-tube (OPIT) tapes. Although these cuprate HTS materials are extremely complex, and their properties present several serious obstacles to the development of wires, many of the problems they posed have been ingeniously solved. Kilometer lengths of 1G BSCCO superconductors have been routinely produced by companies in the United States, Germany, Japan, and China.

The fine BSCCO filaments tolerate an acceptable amount of bending, like the fine glass filaments in flexible fiber-optic cables. Most important, the processing aligns the crystalline BSCCO grains within a filament, so that the crystalline *c*-axis of the BSCCO grains is roughly perpendicular to the tape plane (to within 10–15°). Within a filament, electric currents can flow from one highly anisotropic grain to another predominantly within the CuO₂ sheets, while transfer between grains takes advantage of the large geometric grain overlap that distributes the weak *c*-axis current over large areas. This so-called “brick wall” structure of 1G wire filaments is central to its success; many basic studies have shown that supercurrent transport across a grain boundary can be greatly suppressed for misalignments greater than a few degrees (the “weak link” effect). This handicap is intrinsic to HTS. Nevertheless, although they have a higher T_c , 1G conductors do not perform as well as the more recently developed 2G YBCO conductors in the ranges of magnetic field and temperature of interest for applications.

Unlike the powder-metallurgy process used to make BSCCO, YBCO conductors are formed as a multilayer coating on a flat substrate, and the associated techniques are referred to as “coated conductor technology” (Figure 2). An initially flat metal foil, typically a nickel alloy, is used as a “substrate,” upon which a buffer layer and then a superconducting YBCO layer are deposited. Cube-on-cube, or (technically) epitaxial growth, is required. The initial texture for the epitaxial growth is either formed within the metallic substrate itself by the rolling-assisted, biaxially textured substrate (RABiTS) method; or, alternatively, in one of the initial buffer layers by using an ion-beam-assisted deposition (IBAD) or inclined-substrate deposition (ISD) technique. (The thin buffer layers prevent metal atoms from diffusing from the substrate into the epitaxial templates and the YBCO layers.) After this, a layer of silver is applied on top of the superconductor to protect it against environmental degradation and to establish continuous electrical contact to the HTS coating. An outer copper layer is typically added over the Ag layer to enable current transfer, stabilization, and strand protection against burnout.

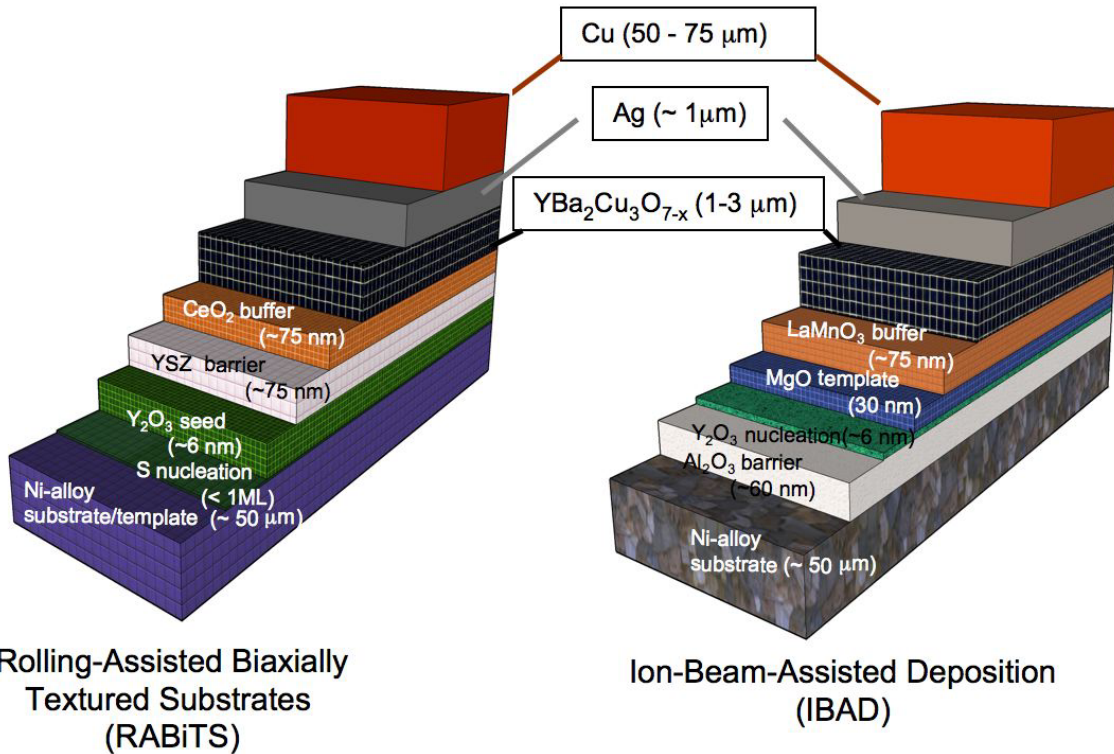

Figure 2 Schematics of the epitaxial multilayer heterostructures that make up 2G “coated conductors.” RABiTS and IBAD are the two approaches being pursued by U.S. industry to yield the near-single-crystal YBCO coating needed for high current performance. (ML = monolayer.)

2G YBCO has several significant advantages over the 1G wire in current use. One of the primary advantages of YBCO is the possibility of in-field operation at liquid nitrogen temperature (77 K), which would result in substantially relaxed cooling requirements. (Refrigeration mass and costs increase dramatically at lower temperatures.) By comparison, operating temperatures would be <10 K for low-temperature superconductors (LTSs) and 30 K for 1G HTS conductors. Another advantage of YBCO is its ability to maintain a high current-carrying capacity (denoted by a critical current density $J_c > 10^6$ A/cm²) in fields up to several tesla; in contrast, current densities in 1G HTS wires begin to decrease dramatically at fields well under 1 T. These advantages are inherent properties of the YBCO superconducting material. Fundamental studies have shown that among all the HTS cuprate material classes, YBCO shows the lowest intrinsic electronic anisotropy, as characterized by the effective supercarrier mass ratio, $\gamma = \sqrt{m_c / m_{am}} \approx 10$. For comparison, 1G BSCCO has a γ of >200. Since large anisotropy drastically weakens the ability of material disorder to pin flux lines against the forces of applied electrical current, 1G conductors suffer an inherent loss of current-carrying capacity in magnetic fields. Also, the strain tolerance (a critical factor for windings) of the YBCO conductor was demonstrated to be superior to that of the BSCCO conductor. Finally, estimates from two leading U.S. manufacturers indicate that the cost of the conductor per unit of current over a unit length of conductor would be much lower for 2G conductors than for 1G conductors, although the exact comparison depends significantly on the machine’s design operating point. The necessity of Ag (which is the only metal that can allow oxygen to flow through to the cuprate inside during its formation) to the 1G conductor process is a strong negative cost factor.

Advances in the YBCO-coated conductors have resulted in dramatic improvements in the quality and length of wire available — from 10⁵ A/cm² at several centimeter lengths a few years ago to >10⁶ A/cm²

performance at lengths exceeding 300 m. These successes have been achieved by improved deposition methods for the HTS layer, more robust and appropriate buffer layer architectures, and fundamental control of the biaxial alignment of the initial buffer layer or underlying metallic substrate. YBCO has intrinsically better in-field current conduction, and because the 2G technology has nearly eliminated the problem of weak intergrain coupling, the present focus has turned to improving the flux pinning in the HTS coating. The significance of the latter may be understood by considering that the 1- to 3- μm -thick HTS layer makes up a very small fraction (possibly only 1–2%) of the entire coated-conductor architecture, compared to $\sim 40\%$ fill factor for the BSCCO in the silver matrix of the 1G tapes. There remains a crucial need to fully optimize the YBCO coating to achieve the maximum performance with the minimum amount of material. Recent progress on short research samples has been impressive, including advances in tailoring the flux-pinning nanostructure and approaches to ameliorate the longstanding problem of a progressive reduction in the critical current density with HTS coating thickness. An important next step is to extend the short sample findings to obtain comparable properties by using practical reel-to-reel HTS deposition processes.

Coated Conductor Templates

IBAD. In 1995, by improving a technique first used by Fujikura of Japan, Los Alamos National Laboratory (LANL) announced record performance of highly biaxially textured YBCO deposited by pulsed laser deposition (PLD). This was enabled by an IBAD layer of yttrium-stabilized zirconia (YSZ), $\sim 1 \mu\text{m}$ thick, on a polycrystalline Hastelloy tape. By extending the process to MgO, Stanford University and LANL have decreased the time for grain alignment by a factor of 100. In this case, texture is achieved with only about 10 nm of vapor-deposited MgO on an electropolished and amorphous-oxide-seeded metal surface. Subsequent buffer layer(s) are then deposited epitaxially to provide a structural template for YBCO and to act as barriers against in- and out-diffusion of chemical contaminants. Excellent substrate grain alignment distributions (full width at half maximum, FWHM) of $\sim 4^\circ$ in-plane and $\sim 2^\circ$ out-of-plane are achieved.

RABiTS. In this approach, the nickel-alloy tape (usually Ni-W) itself is rendered highly biaxially textured by well-defined thermomechanical processes of rolling deformation, followed by annealing. The resulting texture in the face-centered cubic (fcc) metal corresponds to cube planes parallel to the tape surface and perpendicular to the tape's long axis. The resulting RABiTS template shows x-ray orientation distributions of $5\text{--}7^\circ$ FWHM in- and out-of-plane, while the grain-to-grain distribution, relevant to intergrain currents, is somewhat tighter at $\sim 4^\circ$. As shown in Figure 2, at present, a three-layer buffer stack is grown epitaxially on the textured metal tape by physical vapor deposition (PVD) processes for chemical and structural compatibility. A key to the functionality of RABiTS is the epitaxial growth of the first, or seed, buffer layer on the reactive metal surface. Careful surface studies helped identify and led to the control of an ordered half-layer of sulfur on the metal surface that apparently mediates the epitaxial nucleation of the commonly used CeO_2 or Y_2O_3 seed layer.

The YBCO Coating

For either type of template, the single-crystal-like YBCO layer can be deposited by using vapor deposition (e.g., electron-beam or thermal evaporation, pulsed laser deposition, metal-organic chemical vapor deposition [MOCVD]) or wet chemical processes (metal-organic decomposition). Worldwide, these methods are being pursued commercially, while in the United States, SuperPower, Inc., is developing MOCVD, and American Superconductor Corporation is developing the solution-based technique. These two general approaches can be distinguished as in-situ and ex-situ, respectively. In the case of MOCVD

YBCO, temperature and ambient gas environments are closely controlled as the substrate tape passes reel-to-reel through the reaction chamber and the HTS layer is epitaxially crystallized. For the solution approach, a precursor chemical mixture is “painted” onto the moving substrate at room temperature. Then, in a second step, the YBCO is grown while the precursor-coated tape is passed through the controlled environment of a furnace. As discussed above, the Ag and Cu layers provide stability against burnout; the details of these addenda depend on the intended application parameters (temperature, field), but they limit the overall engineering current density (J_c) that is central to the design of magnetic power equipment.

Magnesium Diboride

In January 2001, a simple binary intermetallic compound, magnesium diboride (MgB_2), was discovered to have an extraordinarily high superconducting transition temperature, 40 K. While this is significantly lower than the critical temperatures of YBCO and BSCCO, it is considerably higher than that of any other simple intermetallic superconductor, and the highest known T_c value for materials for which the mechanism of superconductivity is well understood (i.e., conventional superconductors). Indeed, the interesting physics that accompanies MgB_2 's superconductivity — specifically, its two-band electronic behavior — has generated much exciting science. Most significantly, strong impurity scattering has been shown to lead to extremely high upper critical fields H_{c2} (the boundary of superconductivity in a magnetic field). This combination of relatively high T_c and substantial critical magnetic fields means MgB_2 meets the performance requirements for some electric power applications, albeit only at moderate operating temperatures. Indeed, round multifilamentary MgB_2 wires have been demonstrated by using conventional wire processing approaches. So far, the attractiveness of operating at liquid nitrogen temperature with the 2G coated conductor technology has limited interest in using MgB_2 for major technological development. Nonetheless, the story of MgB_2 is an important lesson that revolutionary conventional superconductors that are free of the problems associated with cuprate materials may be possible. Hence, the search for new higher-temperature conventional superconductors is a prime area of basic research with the potential to dramatically influence the power applications of superconductivity.

Technologies Related to Superconductor Use

Integration of superconductivity into the power grid requires research in materials and techniques beyond those for the superconductor itself. For instance, all systems require the use of cryogenically cooled dielectrics, magnetics, insulators, and semiconductors to be used in power control circuits. Furthermore, the cryo-refrigerators employed to cool the system are at present far below theoretical efficiency, and, as such, the total operational costs will be higher than they need to be. Research in these nonsuperconducting materials and refrigeration performance will be vital to the full implementation of a superconducting system. It will be necessary to establish a basic understanding of superconducting-system-related cryogenic materials and phenomena to enable the broad application of superconductors. For the HTS materials in their present conductor forms, the principal advantage over conventional devices can be summarized as *smaller, lighter, and higher capacity*. The energy savings at present are less than thermodynamics permits, mainly because of problems with refrigeration and cryogenic efficiency, which points to one of the needed advances in complementary technologies.

Refrigeration. The liquid helium temperatures required by LTS wire were a major drawback because of the early technology level of refrigeration equipment. The technological challenge of thermally isolating the cryogenic windings was another problem of earlier development efforts. The significantly higher operating temperatures of the HTS conductors over LTS conductors are a major breakthrough for using

superconductors in power generation systems. The operating temperatures for BSCCO (20–35 K) and YBCO (60–77 K) HTS conductors, based on the performance of these conductors in an applied magnetic field, eliminate the need for a continuous supply of liquid cryogenics. Even the new superconducting intermetallic MgB₂ has an operating temperature of 20–30 K. Cryogenic refrigerators (cryocoolers) can cool the HTS conductors without the complications and logistics of a liquid cryogen tank. Reliable cryo-refrigerators have been commercially available for years, but the larger-cooling-capacity versions are not as efficient as they should be.

SCIENTIFIC CHALLENGES

The utility of practical superconducting electric power conductors depends on both their performance and their cost. There are many use-inspired scientific challenges that, if successfully met, will both improve performance and reduce cost. They fall into three broad areas, as described below. They include optimizing the present 2G materials and developing new superconductors that will be needed to open up the full range of electric power applications to which superconductivity can contribute.

Research and Development for 2G Conductors

With the advances mentioned in the previous section and the establishment of continuous processing, new research should address the remaining developmental issues of YBCO-coated conductor performance. For example, improvements to this HTS conductor must focus on maintaining high current densities in fields of a few tesla while simultaneously minimizing ac losses and promoting stability. The present-day coated conductor architecture has a series of buffer layers that should ideally be reduced to just one or none.

Through a series of workshops sponsored by its technology program, DOE has established out-year goals for the performance of 2G wire in order to meet the needs of the electric power sector. Goals for tape fabrication for the next four years are in response to specific research thrust areas:

- Maximizing critical current (which is essential)
 - 300 A/cm-w, 100 m, by 2006
 - New (proposed): 200 A, 4.4-mm wide, in magnetic field $H = 3$ T parallel to the c-axis, $T = 65$ K, by 2008
 - 1,000 A/cm, 1,000 m (77 K, $H = 0$), by 2010
- 5% or less variation in properties along the wire length
- Current proportional to HTS thickness

A perspective on these goals and present performance levels can be seen in Figure 3. We must overcome present-day length limitations by improving texture uniformity, layer uniformity, interlayer reactivity, localized flaws, and long-range variations. Long piece-lengths and high throughput are essential for high-volume manufacturing of low-cost conductors.

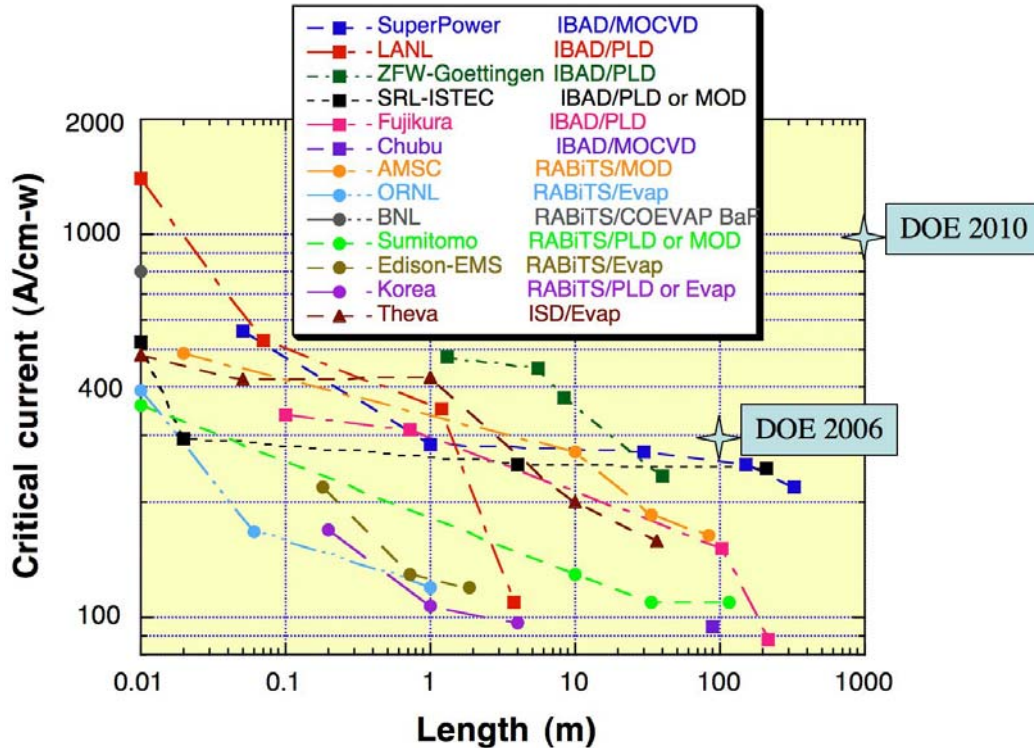

Figure 3 Performance levels of prototype 2G conductors (May 2006). The metric plotted is the critical current per unit width of tape (A/cm-w), measured at 77 K in self field. As piece-lengths increase, the current levels decrease, a problem that needs to be solved when approaching the indicated DOE goals. The inset identifies the research organization on the left and the fabrication method on the right.

Higher Critical Currents. Higher critical currents can be achieved either by improving the critical current density of the material or by depositing thicker films. Although very recent progress has been made in this area, there remains ample room for improvements that would offer tremendous benefits (see Panel Survey: “Basic Research Challenges for Vortex Matter”). The importance of superconductor performance cannot be overstated, since every factor-of-two increase in the critical current translates directly to halving the cost per kiloampere-meter of wire. Improved critical currents will require an understanding of the vortex pinning that can achieve the theoretical limits, the microstructures that can achieve this performance in practice, and the science of materials growth and processing that will permit the needed microstructures to be achieved at the lowest cost. Improved pinning methods will be necessary, as will alternative materials to reduce the supporting structure cross section of the YBCO conductor, so that the overall engineering current density will improve as well. A 2G tape capable of carrying 500 A/cm-w at 77 K would satisfy the requirements of *many* applications, allowing initial market penetration of this superconducting power conductor.

AC Losses. Minimizing ac losses in the HTS coated conductor is important to ac applications. These losses have the following components: hysteretic, ferromagnetic, eddy current, and coupling current losses. Losses may also be incurred from self-field transport currents. Ferromagnetic loss components can be removed by finding nonferromagnetic substrates in place of Ni-W (RABiTS). Eddy currents and coupling currents can be reduced by increasing the matrix resistivity; previous work on superconducting wire intended for ac applications (in the LTS era) led to NbTi-based strands with ultrafine filaments and

CuNi matrices. Creating a multifilamentary coated conductor is more difficult because of the fabrication routes in use, and twisting is even more difficult because of the tape geometry. Ideally, a conductor with transposed filaments should be made. Present-day striation techniques developed for low ac loss must be adapted to long lengths, requiring a fundamental understanding of the processes involved. Improved modeling of the various loss mechanisms is necessary to understand what the losses in the system will be, especially if combined field and current interactions result in a dynamic resistance loss. Ferromagnetic shielding should also be considered.

Deposition Kinetics and Reactions. The HTS layer is the most complex in the coated conductor architecture. Yield will be primarily determined by the HTS layer, so the focus must be on reducing the complexity and cost of processing. The dynamics of the phase-formation process must be better understood; this may include the chemical reactions in the solution-based processes, gas-phase kinetics of MOCVD, YBCO precursor utilization efficiency, and nonplanar deposition processes.

Research and Development for Cryogenic Supporting Technologies

Refrigerators. The cryogenic system's lifetime cost, including both capital cost and operation and maintenance (O&M) cost, must improve by a factor of at least five. Efficiencies should be improved to 30% of Carnot efficiency, which would double that of current systems. Vacuum-jacketed cable cryostats for the HTS device must be reliable to improve the system's design lifetime. Work is needed on three-dimensional fluid-dynamic modeling and flow visualization experiments with Stirling cycles and other pulse tube cycles in order to understand boundary layer and other nonideal effects on cycle gas flows. We also need to understand hydrogenic out-gassing mechanisms in real materials and how the physical-chemical action in new getter materials (ability of certain solids to absorb free gases) can affect longer intervals between getter replacement or conditioning.

Cryogenic Dielectrics. New insulation materials require basic research on dielectrics at cryogenic temperatures. It is particularly important for these materials to have high thermal conductivity and low electrical conductivity to allow for rapid heat removal to achieve stability or to allow for the quick introduction of heat to achieve quench protection. It may also be possible to design insulation that switches from insulating to conducting with a rise in temperature to achieve quench protection. The incorporation of nanometer-size particles in a matrix to form dielectric composites shows promise for materials (nanodielectrics) with new and improved properties. The properties of the interfaces between the particles and the matrix will have an increasingly dominant role in determining dielectric performance as the particle size decreases. The forces that determine the electrical and dielectric properties of interfaces influence the composite behavior. Scientific issues to be addressed include the tailoring of the dielectric properties of nanoparticles by substitutional chemistry, the derivation of nanoparticles for compatibility with a polymer matrix, the control of interfacial effects, the modeling of nanocomposites and consideration of interfacial effects, self-assembly in a polymer matrix, and the relationship of the space charge to the breakdown strength of nanocomposites.

Cryopower Electronics. Most electrical devices and systems require power controls to perform their functions. For instance, motors require power electronics to change the current, voltage, and frequency that permit the motor to operate at various speeds and power levels. A device or system that uses superconductivity (wire, cable, or coil) could improve its overall efficiency and power density by keeping the power controls in the same cryogenic environment as the superconducting component. This would also greatly alleviate the engineering complexity of bringing numerous high-voltage leads into and out of

a cryogenic enclosure. Thus, research aimed at investigating the use of “nonsuperconducting” power electronic components at cryogenic temperatures and the integration of these components in a compact control module will greatly enhance the utility of superconducting technology.

Inductors and transformers are part of electronic power controls. Room-temperature inductors and transformers all use low-loss magnetic cores. These magnetic cores, optimized for performance at room temperature, become “lossy” at cryogenic temperatures. Thus, research in magnetic core materials that are “optimized” for cryogenic operation is needed. Similarly, capacitors contain dielectric materials optimized to yield top performance at room temperature. Dielectric materials and capacitors optimized for operation at cryogenic temperature need to be developed. Finally, the semiconducting “active” elements in power electronic controls (e.g., metal-oxide semiconductor field-effect transistors [MOSFETs], insulated-gate bipolar transistors [IGBTs], gate-turnoff [GTO] thyristors) are all room-temperature silicon-based devices, and most will not operate at cryogenic temperatures. Development of Ge-based semiconductors that operate efficiently at cryogenic temperature would greatly improve cryogenic power controls.

IMPACT

In 2004, electrical energy production was almost 4,000 TW-h; three-quarters of this was from fossil fuel sources. Energy losses associated with power transformation, transmission, and distribution approached 8% (10% on the grid). These losses could be cut approximately in half — amounting to more than \$10 billion in annual savings — with the full implementation of superconducting technology, including underground transmission cables, transformers, power-quality devices, and FCLs.

High-temperature superconductors have the potential to revolutionize electric power generation, distribution, and end use. Success in the use-inspired basic research described here will be necessary to fully realize this potential. It would provide the scientific foundation necessary for the optimization (performance and cost) of the present 2G YBCO-coated-conductor technology, and it would provide superconductors that can extend the performance envelope to include the full range of imaginable superconducting power applications.

Through the Superconductivity Partnership Initiative (SPI), DOE has co-sponsored the construction and operation of prototype superconducting power equipment to demonstrate the feasibility of the concepts discussed below. Through basic research initiatives, we can overcome the final technical obstacles and make HTS conductors cost-competitive. Doing so will allow commercialization of superconducting power equipment and result in the benefits summarized here. The emergence of the HTS utility markets has been estimated to be about \$1.8 billion per year within the next 20 years.

Superconducting transmission cables: These HTS cables can meet increasing power demands in urban areas via retrofit applications, since they can carry up to five times more power than conventional cable; eliminate the need to acquire new rights of way; replace overhead transmission lines when environmental and other concerns prohibit their installation; enhance overall system efficiency as a result of exceptionally low losses; increase utility system operating flexibility; and reduce electricity costs. DOE’s Energy Information Administration (EIA) estimates that transmission and distribution losses, including losses at substations, are 10% of the total electrical energy produced. Deployment of superconductors may reduce this figure to 3%, resulting in huge energy savings on a national scale.

Superconducting motors: The HTS motors will have one-half or less the size, weight, and energy losses of conventional large motors. The lower losses integrated over national consumption would result in

significant energy savings. Superconducting motors are inherently more electrically stable during transients than conventional motors because the former operate at smaller load angles (15° versus 70° for a conventional motor) and have a much higher peak torque capability ($\sim 300\%$). As a result, the superconducting motor can withstand large transients or oscillatory torques without losing synchronous speed. The HTS machines do not require rapid field forcing during fast load changes or transients, as is often the case with conventional machines.

Transformers: These HTS devices will result in a 30% reduction in losses, have about one-half the weight and footprint, and are oil-free and so could possibly be operated inside structures. If all transformers in the United States equal to or greater than 100 MVA were replaced with HTS transformers, the lifetime energy savings from conventional transformer losses could account for 340 billion kWh, or \$10.2 billion. Furthermore, conventional transformers can be overloaded for only short periods of time (200% for 30 minutes). HTS transformers can carry overloads with no decrease in equipment lifespan and manageable additional load losses. Additional benefits include reduced environmental concerns resulting from the elimination of fire and environmental hazards of cooling oil, along with more real and reactive power and improved voltage regulation.

FCLs: Fault current levels can be up to 20 times the steady-state current. The superconducting FCL will limit fault current to 3 to 5 times the steady-state current, reduce standby energy losses, and provide improved flexibility in the use of existing lower-rated circuit breakers and fuses. Also, no capacitive correction is needed with a superconducting FCL, since it has no reactance and is passive during nonfault conditions.

Generators: A 1,000-MW superconducting generator (a typical size in large power plants) could save as much as \$4 million per year in reduced losses per generator. Even small efficiency improvements produce big dollar savings. An improvement of 0.5% gives a utility additional capacity to sell; the related value is nearly \$300,000 per 100-MVA generator. The benefits of the commercial superconducting generator include increased machine efficiency beyond 99%, which reduces losses by as much as 50% with respect to conventional generators; reduced pollution per unit of energy produced; lower life-cycle costs; enhanced grid stability; reduced capital cost; and reduced installation expenses.

SUPERCONDUCTIVITY IN A "SMART, SELF-HEALING GRID"

Today, power anomaly and disturbance problems in the United States contribute to annual economic losses of \$120 to \$190 billion. As electric power demands continue to rise, stability and protection become ever more important issues and must be provided by devices that react quickly and dynamically to load disruptions. Examples of two such devices are the superconducting synchronous reactive power generator and the fault current limiter.

Reactive Power Generator: In the ac grid, the power can deliver useful work only when the current and voltage are perfectly in phase. Shifts in the relative phase between the ac current and voltage can arise from intrinsic reactive impedance elements of the grid in combination with inevitable varying load demands. For example, the switching in and out of load devices such as large motors, arc melters, etc. introduces changes in both reactive and overall load impedance. Referring to the simple effective grid circuit shown in Figure (a), the average real power delivered is

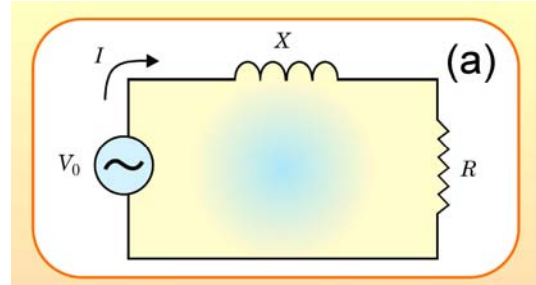

$$P = \frac{V_0^2 \cos \phi}{\sqrt{R^2 + X^2}}, \text{ while the volt-ampere reactive power (VAR) is } Q = \frac{V_0^2 \sin \phi}{\sqrt{R^2 + X^2}}, \text{ where the phase angle is determined by}$$

$$\cos \phi = R / \sqrt{R^2 + X^2}.$$

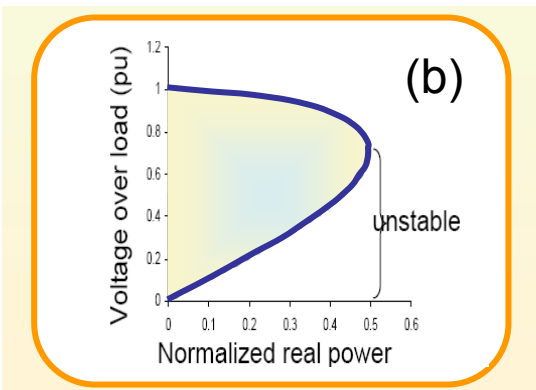

Although VAR is constantly supplied and then recovered on each 60-Hz cycle, it requires additional current that stresses the grid. A superconducting reactive power generator installed on-line can react quickly and efficiently to provide continuously variable reactive power to counteract phase shifts. Its benefits derive from there being virtually no heating in the rotor, the ability to respond with lots of reactive current, and its small size and weight, which can facilitate siting at confined substations in areas near locations where reactive compensation is needed. Figure (b) illustrates the significance of controlling VARs, since a drop in voltage due to excessive phase angle or load can lead to a complete unstable collapse, as occurred in the U.S.-Canada power outage of 2003.

Fault Current Limiter (FCL): Abrupt, catastrophic grid transients, such as a short circuit or lightning strike, can induce currents of up to 60 kA, approaching the limits of conventional circuit breakers. Because of their highly nonlinear voltage-current characteristics, superconductors can act as "smart" switches, rapidly converting from zero to finite resistance as the current exceeds a critical value. One design for a superconducting FCL is shown in Figure (c). The superconducting resistor (red) "shorts out" the current-limiting inductor at operating current, but it then "switches in" the inductance to provide extra impedance, thereby limiting the current during a fault.

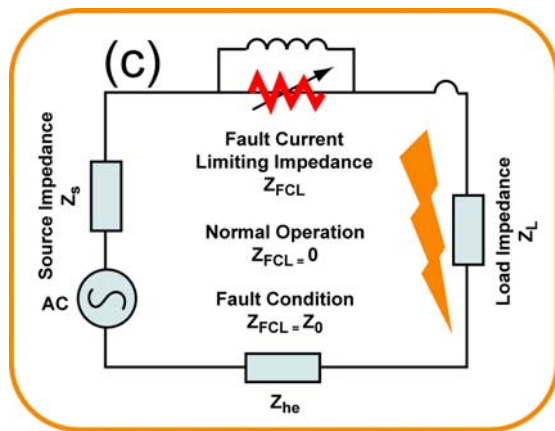

REFERENCES

- American Superconductor, Inc., *Motors, Generators, and Synchronous Condensers*; available at <http://www.amsuper.com/products/motorsGenerators/quickVAR.cfm>.
- American Superconductor, Inc., "Remote Energy by Wire: Pathway to a More Secure Energy Future," white paper REBW-WP-01-1004 (2004); available at http://www.amsuper.com/documents/SecEnrgFutWhitePaper_rv10_18.pdf.
- P.N. Arendt and S.R. Foltyn, "Biaxially Textured IBAD-MgO Templates for YBCO-coated Conductors," *MRS Bulletin* **29**, 543 (2004).
- G. Blatter, M.V. Feigelman, V.B. Geshkenbein, A.I. Larkin, and V.M. Vinokur, "Vortices in High Temperature Superconductors," *Rev. Mod. Phys.* **66**, 1125 (1994).
- C. Cantoni et al., "Quantification and Control of the Sulfur c(2×2) Superstructure on (100) <100> Ni for Optimization of YSZ, CeO₂, and SrTiO₃ Seed Layer Texture," *J. Mater. Res.* **17**, 2549 (2002).
- EIA (Energy Information Administration), *Electric Power Annual — Summary Statistics for the United States*, U.S. Department of Energy (2005); available at <http://www.eia.doe.gov/cneaf/electricity/epa/epates.html>.
- EIA, "Electricity Demand and Supply," p. 77 in *Annual Energy Outlook 2006: With Projections to 2030*, DOE/EIA-0383, U.S. Department of Energy (2006); available at http://www.eia.doe.gov/oiaf/aeo/pdf/trend_3.pdf.
- EPRI (Electric Power Research Institute), *Powering Progress, 1999 Summary and Synthesis*, EPRI electricity technology roadmap; available at http://www.epri.com/corporate/discover_epri/roadmap/CI-112677-V1_all.pdf.
- M.J. Gouge, J.A. Demko, B.W. McConnell, and J.M. Pfothenauer, *Cryogenics Assessment Report*, University of Wisconsin (May 2002); available at <http://www.ornl.gov/sci/htsc/documents/pdf/CryoAssessRpt.pdf>.
- A. Goyal et al., "The RABiTS Approach: Using Rolling-assisted Biaxially Textured Substrates for High-performance YBCO Superconductors," *MRS Bulletin* **29**, 552 (2004).
- Los Alamos National Laboratory, *Coated Conductor Champion Results — Status as of August 30, 2005*; available at <http://www.lanl.gov/superconductivity/score.shtml>.
- J. Mulholland, T.P. Sheahen, and B. McConnell, "Energy Savings in HTS Devices," Appendix 1 in *Analysis of Future Prices and Markets for High Temperature Superconductors*, U.S. Department of Energy (Sept. 2001); available at <http://www.ornl.gov/sci/htsc/documents/pdf/Mulholland%20Appendices%20Rev%20063003.pdf>.

BASIC RESEARCH CHALLENGES FOR VORTEX MATTER

The behavior of superconducting vortex matter determines how a superconductor's current-carrying capability affects its suitability for technological applications. The study of vortex matter spans the broad spectrum from discovery science through use-inspired basic research to applications. Beyond its fundamental impact on all practical applications of superconductivity, its theoretical concepts touch upon the subjects of cracks and dislocations in solids, the dynamics of domains in magnets, and the physics of localized electrons in metals. The static and dynamic phenomena emerging from a collection of vortices — nanoscale magnetic flux tubes generated by circulating micro-tornadoes of superconducting electrons — are responsible for the stability of the zero-resistance state in superconducting wires, the sensitivity of the best magnetic sensors, and the generation of terahertz radiation in novel ways. This panel addresses the theoretical and phenomenological aspects of vortex matter and their expected impact on future exploitation of vortex phenomena for applications.

The discovery of high-temperature superconductors dramatically broadened the range of the temperatures and magnetic fields considered when studying vortex matter and introduced qualitatively new static and dynamic features into its behavior. Since that discovery, remarkable progress has been made in our understanding of vortex matter. We have observed the melting of an ordered array of vortices (vortex lattice) into a novel vortex liquid phase. We continue to search for means to “dam” or “pin” the flow of the vortex liquid, a necessary condition for achieving zero-resistance superconductivity at high temperatures. We have discovered several disorder-induced new phases of vortex matter, some even competing with one another. New vortex phases are also observed when the dimension of the vortex matter is reduced, as in the highly anisotropic layered cuprate superconductor $\text{Ba}_2\text{Sr}_2\text{CaCu}_2\text{O}_x$ (BSCCO). Also, we now have a better understanding of vortex behavior at the elevated temperatures at which the cuprate superconductors operate. For example, thermal energy can occasionally encourage a vortex to “hop” out of one pinning site and into another. As described in the text that follows, the movement of a vortex is dissipative. This type of hopping motion, called vortex creep, can lead to slow current dissipation, which disrupts the zero-resistance current flow and constitutes a new problem that must be solved before practical applications of these superconductors at high temperatures will be possible. Recently developed theories of vortex creep have brought about a breakthrough in our understanding of the fundamental limits on the extent to which electrical loss can be avoided in high-temperature superconductors.

The recent discovery of new classes of superconductors (e.g., the multiband superconductor magnesium diboride MgB_2 , the p-wave superconductor Sr_2RuO_4 , and the relatively high-critical-transition-temperature (high- T_c) heavy fermion superconductor PuCoGa_5) provides opportunities to investigate vortex matter in entirely new classes of superconducting materials. These investigations could inspire the much-needed development of a microscopic theory of vortex pinning, which undoubtedly would lead to novel schemes for attaining higher current-carrying capacity in superconductors. A recent theoretical success story is the prediction that the upper critical magnetic field H_{c2} (the highest magnetic field under which a superconductor can maintain its superconducting properties) of MgB_2 can be increased by electron scattering between the conduction bands. This theory explained the observation of a remarkable tenfold increase of H_{c2} in MgB_2 . Another theoretical advance is the prediction of “tunable” terahertz emission from a micrometer-sized BSCCO single crystal. Experimental confirmation of this phenomenon could profoundly impact medical imaging for cancer detection and even for the detection of explosives.

Rapid progress in nanoscience and technology has also powered the vortex physics field with the introduction of such sophisticated techniques as environmental scanning tunneling spectroscopy, nanocalorimetry, Lorentz microscopy, and micro-Hall sensor magnetometry, which now allow us to image an individual vortex directly and study its electronic and magnetic structures and interactions at the

nanoscale. Furthermore, new bottom-up approaches have recently been exploited to create self-organized, nanosized vortex pinning sites to abate vortex motion, a necessary condition for achieving loss-free current. Nanotechnology has also provided new methods of fabricating hybrid superconductor-magnetic structures to investigate advanced concepts, such as magnetic vortex pinning. Arrays of nanomagnetic structures on a superconductor have been used to optimize the capacity of superconductors to carry current at a particular magnetic field. An emerging new area is the study of the vortex behavior found in mesoscopic superconductors, where boundary effects begin to dominate the bulk properties, leading to novel vortex states. The exploitation of architected shape in addition to “nanosizes” for vortex pinning has yet to be explored.

With powerful computing tools that were not available until recently, complex modeling of vortex interactions with materials-specific defects may soon become a possibility. With these experimental and computational developments and tools, we may be poised to optimize (i.e., maximize) the current-carrying capacity of any superconductor. This optimization will be an ambitious endeavor requiring the close coordination of theory, simulations, materials synthesis, and nanocharacterization.

All of the theoretical and phenomenological aspects of vortex matter described above have direct consequences for the application of these materials in the commercial sector. Having the ability to design a superconductor that can maintain its maximum current-carrying capability up to its highest operating temperature would reduce the cost of superconducting wire and lower the cooling cost of superconducting electrical transmission. Industry is currently gearing up to introduce high-temperature superconducting cables into the electric distribution grid. Understanding the behavior of vortex matter under many potential operating environments, so that the cable can be designed to optimize the operation of the superconductor, will help to mitigate the increasing demand for electric transmission. Exploiting the unique resistive properties of superconductors — such as vortex creep under high current flow — to develop superconducting fault current limiters may eventually enable us to create a futuristic self-healing electric grid, in which electricity will naturally self-regulate its flow to the places where it is needed.

BACKGROUND

Vortex Matter

Vortex matter is an ensemble of discrete magnetic flux tubes. Each vortex is created by superconducting electrons circulating around a nonsuperconducting “normal” core. These Abrikosov vortices appear in a superconductor in the presence of an external magnetic field above a certain field limit (see sidebar, “What Is a Vortex?”). In pure superconductors, these vortices form a triangular array similar to a crystalline solid. Like solids, these ordered arrays of vortices can melt at high temperatures, leading to a liquid of wriggling magnetic field lines. Great strides have been made in vortex physics since the discovery of high-temperature superconductors in the cuprates because vortices are present in these materials over a much wider range of temperature and magnetic field than in the low-temperature superconductors previously available.

Anisotropy, brought about by these materials’ layered structures, affects every aspect of high- T_c superconductors. The anisotropy is quantified by the parameter $\gamma = H_{c2}^{ab}/H_{c2}^c$, which is the ratio of the upper critical fields measured along and perpendicular to the planes, respectively. In yttrium barium copper oxide (YBCO), γ is ~ 5 – 7 ; in highly layered superconductors, such as BSCCO, the crystal structure consists of superconducting planes separated by thin insulating layers, and γ is >200 . In these structures, the vortices described above can take on a two-dimensional (2-D) nature, forming flattened “pancake” vortices whose circulating superconducting electrons and corresponding normal cores are

WHAT IS A VORTEX?

The performance of superconductors in most technical applications is determined by the properties of superconducting vortices. Vortices form in a wide class of superconductors — the type II superconductors — when these materials are exposed to magnetic fields.

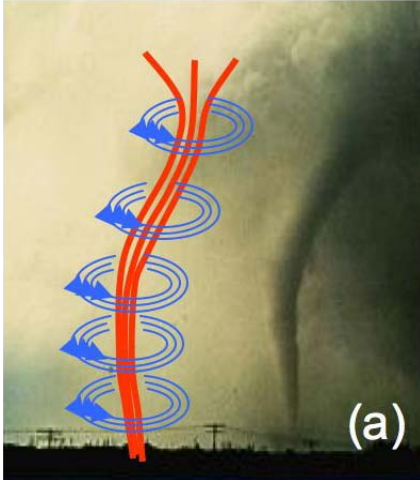

A superconducting vortex can be viewed as a magnetic micro-tornado, as shown in Figure (a). The eye of the tornado corresponds to the normal (nonsuperconducting) vortex core, which is surrounded by encircling supercurrents. Two lengths characterize the vortex: The London penetration depth, λ , measures the radial extent of the circulating currents, and the coherence length, ξ , is roughly the size of the normal-conducting core. For cuprates, ξ and λ are in the nanoscale, ~ 1.5 nm and ~ 150 nm, respectively. The circulating currents confine the field lines of the applied magnetic field to the vortex region [Figure (b)] in such a way that each vortex in a bulk superconductor carries exactly one magnetic flux quantum, $\Phi_0 = 2.07 \times 10^{-15}$ Tm².

When two parallel vortices come close to each other, they repel one another, as shown in Figure (b). As a result of the circulating currents, the vortices can be viewed as small solenoid magnets, each with its north pole on the top and its south pole on the bottom. Thus, they will repel each other just like two parallel bar magnets. This mutual repulsion forces vortices to arrange themselves as far apart as possible within the confines of the superconducting sample. The resulting vortex arrangement is a periodic structure called the Abrikosov vortex lattice. This lattice usually has a hexagonal pattern. An experimental observation using magnetic particles to “decorate” the vortices on superconducting Nb at $T = 1.2$ K and in a magnetic field of 985 Oe is shown in Figure (c) (courtesy of U. Essmann, unpublished; see also *Phys. Lett.* 24A, 526 [1967]). The Abrikosov vortex lattice appears in

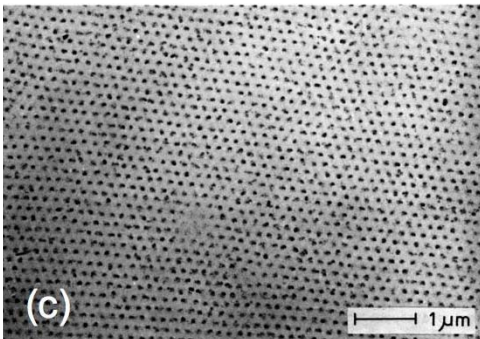
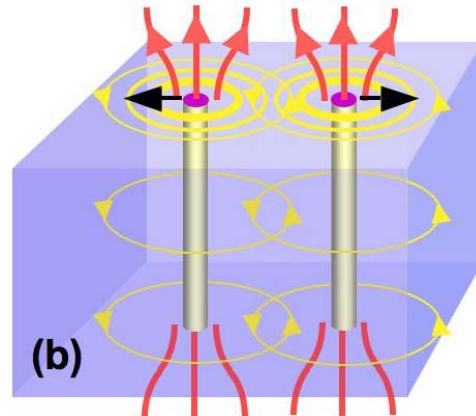

clean superconductors in which there are no defects to interfere with the positioning of the vortices. In many materials, defects, such as precipitates or dislocations, distort the arrangement of the vortices. The average distance, a , between vortices is determined by the applied field, according to $a \sim \sqrt{\Phi_0 / B}$. In a field of $B \sim 0.1$ T, a value typical for power transmission and transformer applications is $a \sim 144$ nm.

SUPERCONDUCTING PHASE DIAGRAM

The superconducting properties of a material depend on the applied magnetic field and temperature. This dependence is commonly illustrated by a "phase diagram" that shows regions of magnetic field and temperature in which certain types of properties are observed. The superconducting phase diagram for a type II superconductor is shown schematically in the figure below.

A type II superconductor (all technologically important superconductors belong to this class) is characterized by two "critical" magnetic fields: the lower critical field, H_{c1} , and the upper critical field H_{c2} . In fields below H_{c1} , the superconductor is in the Meissner state. In the Meissner state, the magnetic field is unable to penetrate the superconducting material. In fact, if a material in a magnetic field below H_{c1} is cooled below its superconducting transition temperature, the magnetic field is suddenly expelled from the material. The lower critical field, H_{c1} , is zero right at the superconducting transition temperature and increases as the temperature is lowered further. The range of temperature and magnetic field over which the Meissner state is observed is illustrated in tan in the figure.

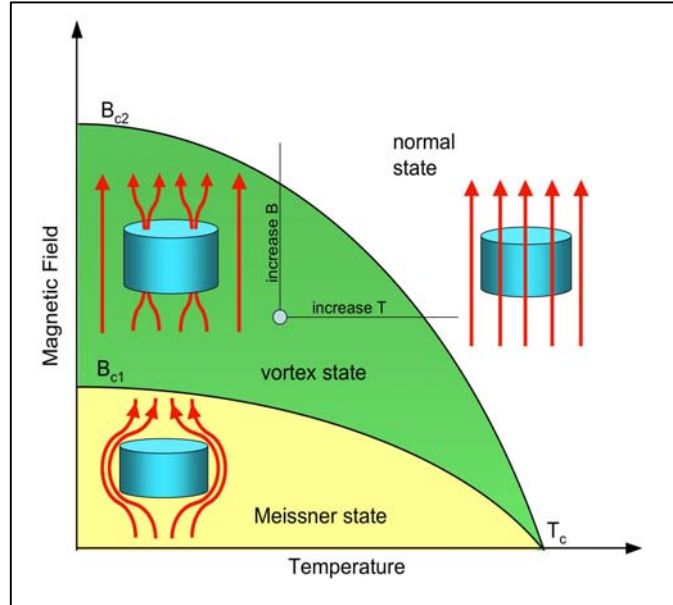

If the magnetic field is increased above the lower critical field, the magnetic field begins to penetrate the superconducting material. It does not penetrate uniformly, however. Instead, the field penetrates in quantized tubes of magnetic flux, known as vortices. The interactions between these vortices are responsible for important and fascinating properties of the materials, as described elsewhere in this report.

As the field is increased from H_{c1} to the upper critical field, H_{c2} , more and more superconducting vortices appear. Eventually, at the upper critical field, the transition into the normal nonsuperconducting state occurs. At that point, the magnetic field penetrates the material uniformly throughout, and all superconducting properties are lost. The range of temperature and magnetic field over which the vortex state is observed is illustrated in green in the figure. The H_{c2} -line is the intrinsic limit to any technological application of a superconductor. The values of H_{c2} at low temperature vary widely among materials; for NbTi and Nb₃Sn (the most commonly used technical superconductors), $\mu_0 H_{c2}$ is ~ 10 T and ~ 23 T, respectively, whereas estimates for the high-temperature superconducting cuprates are well above 100 T.

Conceptually, the transition at H_{c2} arises when the normal conducting cores of the vortices overlap and when there is no space for superconducting material left in-between them. Starting at a given temperature and field marked by the grey dot in the figure, as the applied magnetic field is increased, the distance between vortices, a , decreases as $a \sim \sqrt{\Phi_0 / B}$, and the transition to the normal state occurs when a equals the size of the vortex core, which is the coherence length, ξ . The normal state may also be approached by increasing temperature at a constant magnetic field, as shown in the figure. In that case, the vortex distance remains fixed, while the core size, ξ , increases as $\xi(T) = \xi_0 / \sqrt{1 - T/T_c}$. When temperature is increased at constant magnetic field, the transition to a normal conductor occurs when the normal cores of the vortex begin to overlap. These results can be summarized in the relationship for the temperature-dependent upper critical field: $\mu_0 H_{c2}(T) = \Phi_0 / 2\pi \xi^2(T)$.

confined to the superconducting layers of the crystal structure. Furthermore, if the external magnetic field is applied parallel to these layers, a special type of Josephson vortex is formed, in which the electrons follow a circulating path between the superconducting and insulating layers. Unlike the Abrikosov and pancake vortices described previously, these Josephson vortices do not have normal cores. Tilting the external magnetic field slightly off the plane can create two vortex species simultaneously. Complex interaction between pancake and Josephson vortices leads to a rich panoply of new vortex matter phases (Figure 4). The interaction of these vortex matter phases with crystalline or induced disorder in superconducting materials lies at the crux of understanding and developing new schemes to enhance the current-carrying properties of superconductors.

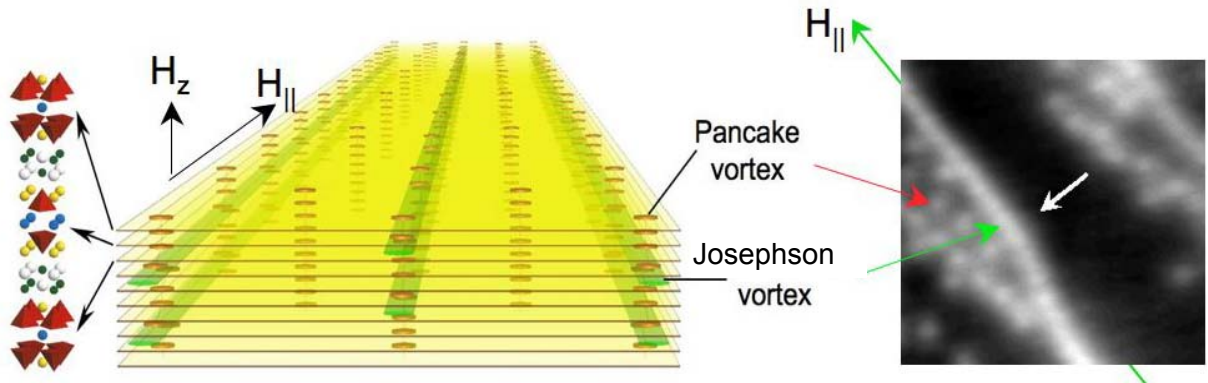

Figure 4 Crossing vortex lattice state of Josephson vortices (green) and pancake vortices (red) formed by tilting the applied magnetic field H in $\text{Bi}_2\text{Sr}_2\text{CaCu}_2\text{O}_x$ (crystal structure shown on left). Scanning-Hall probe microscopy showing the coexistence of pancake vortices (bright dots) with a Josephson vortex (bright line) (far right). The latter is observed because of its interaction with pancake vortices. In this particular image, a BSCCO single crystal was field-cooled in a perpendicular magnetic field of $H_z = 10$ Oe (with the in-plane field $H_{\parallel} = 0$). H_z was subsequently set to zero at a temperature of 77 K. The in-plane field was then increased from zero to $H_{\parallel} = 39$ Oe and generated stacks of Josephson vortices, which then swept out the trapped pancake vortices in their direction of motion (white arrow). (Image size is $\sim 26 \times 26 \mu\text{m}$.) (Courtesy of S. Bending et al., University of Bath)

Vortex Phases, Disorder, and Pinning

Vortices in high-temperature superconductors, interacting with structural defects of the material, can form three distinct phases: vortex lattice (almost perfect crystalline structure); glassy vortex state (strongly disordered vortex solid); and vortex liquid (disordered phase in which thermal fluctuations destroy the crystalline order), as shown in Figure 5. The current-carrying capacity of a superconductor varies considerably between these vortex phases. The critical current density, $J_c(H, T)$, is the maximum current density a superconductor can carry before it quenches to a resistive state. The vortex lattice state usually occurs in phase-pure superconducting materials and is characterized by a very low critical current density. The glassy vortex state, on the other hand, is characterized by high critical currents due to pinning, which destroy the order of the vortex lattice by immobilizing

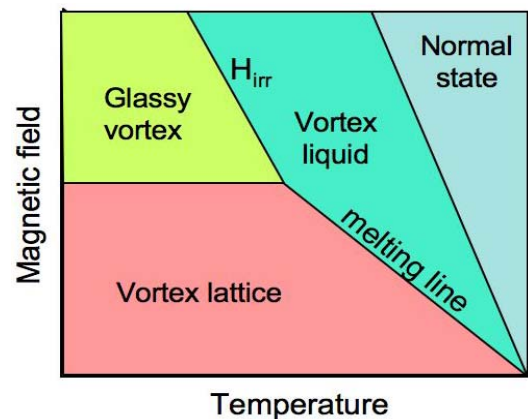

Figure 5 Schematic vortex phase diagram of a high-temperature superconductor. (H_{irr} = irreversibility field, discussed later)

individual vortices at randomly located material defect sites. It is the vortex motion that leads to resistance and limits the current-carrying capacity of these materials. Finally, the vortex liquid state, characterized by large thermal energies, consists of randomly flowing vortices and thus never has a loss-free current flow. In the liquid phase, pinning is strongly reduced, vortices can flow around defects, and the superconductor exhibits electrical resistance like a normal metal. In highly anisotropic superconductors, thermal energies can not only melt the vortex lattice but also decouple the pancake vortices in different layers (Figure 4). In the decoupled state, pancake vortices in different layers can move independently. The scientific challenge is to develop new strategies to increase the pinning energy, thereby raising the current-carrying capacity of the superconductor in the glassy vortex phase and concurrently enabling operation at high temperatures and magnetic fields.

The vortex ordering is determined by the interplay among the three major energy scales associated with vortices: (1) the repulsive interaction energy between vortices, which is determined by the magnetic field and related to the elasticity of the vortex lattice; (2) the attractive interaction energy between a vortex and a defect structure, called the pinning energy; and (3) the thermal energy, which leads to “vibrational” fluctuations of a vortex about its lattice position and is determined by the temperature. These competing energies determine which vortex phase is observed at a given magnetic field and temperature, as shown in Figure 5, and they also determine the current-carrying capability of each phase.

Sending an external current through a superconductor in the presence of a magnetic field (conditions found in a superconducting electric motor, for example) induces a so-called Lorentz force, F_L , on the vortices, where $F_L = \Phi_o J$, with Φ_o being the magnetic flux quantum carried by each vortex and J being the applied current density (Figure 6a). When superconductors contain nonsuperconducting normal inclusions due to structural defects, vortices (with their own nonsuperconducting normal cores) will place themselves on these “defected” sites, thereby minimizing their superconducting energy. This phenomenon, called vortex pinning, forms the foundation for all electro-technical applications of superconductors (Figures 6b and 6c). The vortices experience an attractive force, F_p , which pins them to

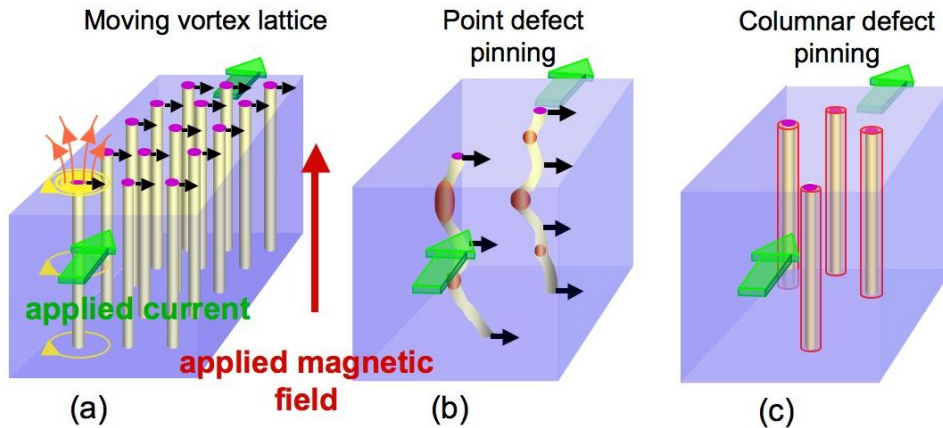

Figure 6 (a) Schematic of vortices moving under a Lorentz force (black arrows) induced by an applied current (green arrow) and a magnetic field (red arrow) in a clean sample free of defects. Note that the direction of Lorentz force is perpendicular to the current and vortex directions. (b) Sections of vortices pinned by point defects (oxygen vacancies, precipitates, or defects induced by electron irradiation). (c) Entire sections of vortices are pinned by line defects, such as amorphous columnar tracks induced by high-energy heavy ion irradiation. Planar defects (twin boundaries, layered structures) can also pin the vortices. In real situations, the defects of a given type are not identical, as they exhibit some dispersion in size, strength, and orientation. Moreover, there is always more than one type of defect present.

these defected sites. When the applied current is large enough that F_L is $>F_p$, the vortices become dislodged from the pinning sites and move. A moving vortex induces a resistance as the normal core of the vortex is dragged through the superconducting matrix. The applied current density at which $F_L = F_p$ is the critical current density, J_c . Generally, J_c decreases with increasing temperature and magnetic field and reaches zero at the so-called “irreversibility line,” $H_{irr}(T)$. Above this line, the superconductor does not carry loss-free current.

High-temperature superconductors contain a high concentration of natural pinning sites, such as oxygen vacancies. To improve the electrical properties of superconductors, one can also manufacture pinning centers artificially, optimizing their shape, size, and arrangement. Linear defects, such as columnar defects produced by irradiation of superconductors with high-energy heavy ions (e.g., Au, Pb, U) and dislocations, have proven to be among the most efficient pinning centers. The sidebar “Some Vortex Pinning Structures in Coated Conductors” illustrates some of the linear and planar correlated defects that are found in YBCO conductors. Because of their geometric match to the vortices, these correlated defects are more effective in pinning the vortices than are randomly placed point defects, which, as shown in Figure 6b, require a vortex line to contort — at the cost of elastic energy — in order to accommodate the pinning sites. Pinning centers with diameters on the order of the coherence length ξ (the size of the normal vortex core) are optimal for pinning individual vortices: Smaller sites cannot fully accommodate the vortex core (and therefore, some energy has to be spent suppressing superconductivity to create the core), while bigger sites waste too much of the useful superconducting body. However, large sites can pin several vortices simultaneously. The problem of artificially creating pinning sites matched to each superconducting material’s specific vortex core size and optimizing their performance for application-specific temperature and field operating conditions is a challenge that is being tackled through recent advances in nanotechnology.

SOME VORTEX PINNING STRUCTURES IN COATED CONDUCTORS

Several types of vortex pinning structures in YBCO thin films and coated conductors can be identified by transmission electron microscopy (TEM).

- (a) YBCO films produced by pulsed laser deposition (PLD) grow in the form of columns (dark and bright contrast). The columnar growth of films produces a proliferation of c -axis dislocations, which give rise to correlated pinning and a c -axis peak in J_c , as in the pure YBCO (undoped) film shown later in the left panel of Figure 9.
- (b) YBCO films produced by metal-organic deposition (MOD) grow in a laminar fashion (i.e., layer-by-layer) (dark and bright contrast). These films do not have c -axis dislocations or the associated J_c peak. In contrast, a large density of extended defects in the ab plane produces correlated pinning and a concomitant larger J_c peak for $H \parallel ab$.
- (c) Columnar defects produced by stacking (self-assembly) of BaZrO_3 (BZO) nanoparticles in PLD-produced YBCO yield a large c -axis peak in J_c , similar to the BZO-doped YBCO film in the left panel of Figure 9.

The large thermal energies that are necessary corollaries of the fact that superconductivity in cuprates exists at relatively high temperature add another challenge to the vortex-pinning scenario. Namely, at relevant temperatures, even when the applied current is subcritical ($J < J_c$), the thermal energy can promote vortex jumps between neighboring pinning sites, resulting in a finite resistance even at low currents (Figure 7a). This vortex creep phenomenon is due to the random distribution of the pinning centers. In this situation, the vortices adjust themselves to the disorder. Each vortex bends, trying to find the energetically best position (ground state) among the pinning sites (Figures 7b and 6b). Because of the random distribution of the pinning centers, these positions are not unique, and different vortex configurations with equal energies are possible. This phenomenon is called *degeneracy of the low-lying energy states*, and it is the main characteristic of the glassy state. Because of the randomness, this degeneracy exists on every spatial scale. The degeneracy results in the complex hierarchical nature of the energy relief of all glasses and gives rise to the peculiar glassy dynamics of *creep*.

Vortex creep is highly nonlinear and non-Ohmic and can manifest itself in aging and memory effects. It sets the fundamental lower achievable limit for power losses due to vortex motion (Figure 7). Vortex creep and the slow decay of critical currents are serious concerns, especially for potential applications requiring highly stable magnetic fields, as in magnetic resonance imaging (MRI) magnets. Finding effective ways of suppressing the strong flux creep that is responsible for the reduced irreversibility field H_{irr} of high- T_c superconductors is one of the major challenges for vortex matter science.

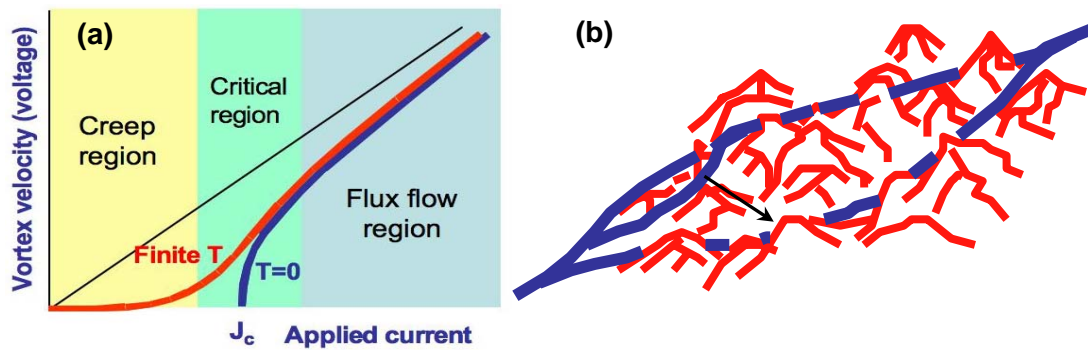

Figure 7 (a) Vortex dynamics in the glassy state. Because of vortex creep, there is finite resistance even at currents well below J_c (red curve) at finite temperature, in contrast to $T = 0$ (blue line). (b) Illustration of a single vortex (blue) residing on top of a pinning energy landscape, which can be visualized as mountains and valleys (red). In the vortex creep process, the vortex can hop (black arrow) from one valley to another as a result of thermal fluctuations.

CURRENT STATUS

Advances in Vortex Pinning

Vortex Pinning and Weak Links. The small coherence length in cuprate superconductors is one of their key advantageous properties, as it is directly linked to their high T_c and H_{c2} (see section on “Vortex Properties of Yet-to-Be-Discovered Superconductors” later in this panel survey), and it also enables effective pinning by atomic-scale defects. Unfortunately, the short coherence length combined with the large anisotropy also generates the “weak link” problem encountered in all technological high-temperature superconductors. At the boundary between two grains of different crystalline orientation, a strong local depression of superconductivity occurs, and, consequently, J_c drops drastically as compared to the bulk or intragrain J_c .

As described in the panel survey on “Basic Research Challenges for Applications,” in first-generation (1G) BSCCO wires, the weak link problem is not solved but is rather circumvented by the development of the “brick wall” structure. The approach taken with second-generation (2G) YBCO-coated conductors is to solve the problem by growing the superconducting film to have a texture (i.e., with all the grains having almost identical crystalline orientation) that will strongly ameliorate or totally eliminate the weak-links current limitation at the grain boundaries. The fabrication of these “single crystals by the kilometer” is one of the most difficult and fascinating challenges in present-day materials science and technology. Laboratory-scale YBCO films grown by pulsed laser deposition (PLD) on ion-beam-assisted deposition (IBAD) MgO templates can now be made with a texture that completely eliminates the grain boundary limitation on J_c . However, although much progress has been made in recent years, the problem still persists in long tapes and in films grown by industrially attractive ex-situ methods on rolling-assisted biaxially textured substrates (RABiTSs).

Thus, understanding the physics of current transport in nanoscale channels between grain boundary dislocations and of vortex pinning along grain boundaries becomes invaluable for developing new ways of reducing the strong current-blocking effects of grain boundaries in high- T_c superconductors for power applications (see Figure 8a). Much progress in theory has already been achieved in order to explain the current-driven vortex structures on planar weak links such as the grain boundaries described above. Theory predicts the existence of Josephson vortices and Abrikosov-like Josephson vortices (called mixed Abrikosov-Josephson vortices) along the grain boundaries (Figure 8b). Mixed vortices arise when the superconducting coupling across the grain boundary is sufficiently strong, leading to Abrikosov vortices with highly elongated cores. Recently, some observers have noted the efficient pinning of the grain boundary vortices by such Abrikosov vortices in the bulk, suggesting new strategies for improving the current flow at grain boundaries.

On the other hand, recent investigations have highlighted that, apart from the grain misalignment, the grain boundary geometry also plays a role in the current transport. Thick ex-situ YBCO films exhibit grain boundaries that deviate significantly from a flat, planar interface. In these films, the boundaries

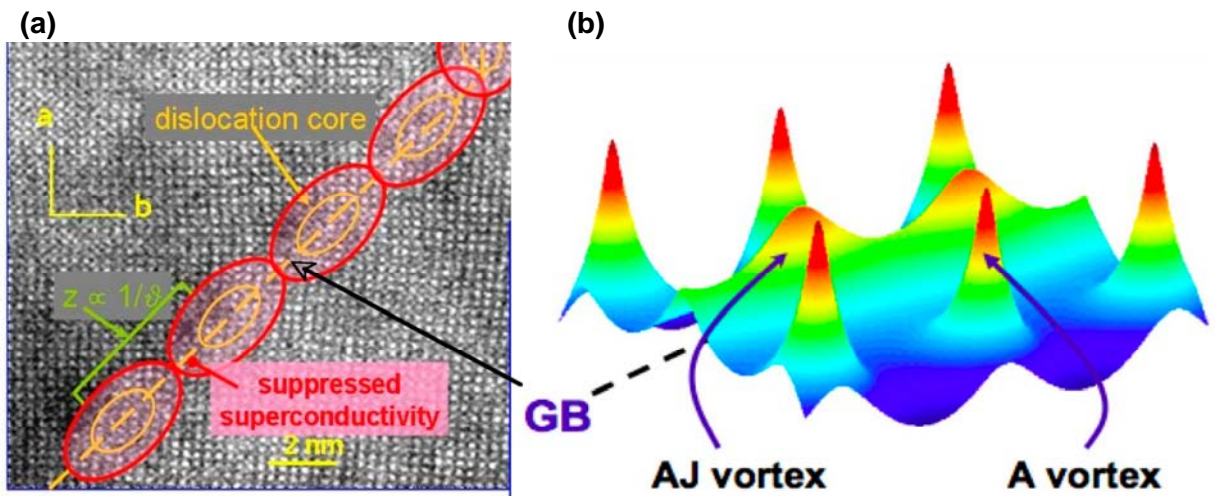

Figure 8 Left panel: Typical grain boundary (GB) in a YBCO-coated conductor, as observed by high-resolution transmission electron microscopy (TEM). A chain of dislocations along the boundary produces a suppression of superconducting properties, resulting in a deterioration of J_c as compared with the “bulk” value. The separation (z) between dislocations is inversely proportional to the misalignment angle (θ) between the grains. Right panel: Theoretical calculation of magnetic field distribution in a planar weak link (dashed line), showing the hybrid Abrikosov-Josephson (AJ) vortices surrounded by bulk Abrikosov (A) vortices.

“meander” through the thickness of the film as well as in the plane of the substrate. Such meandering boundaries pose reduced obstacles to current flow, apparently as a result of a larger contact area and reduced vortex interaction. Controlled engineering of the meandering could solve the grain boundary problem in ex-situ YBCO films and may be relevant for the next generation of superconducting wires.

Strong Pinning in the Vortex Solid. Once the grain boundary problem has been controlled, the next fundamental task of linking theory to applications is to understand how to increase the intragrain J_c and the irreversibility field $H_{irr}(T)$. As explained above, this must be achieved by pinning the vortices to materials defects, which turns the vortex lattice into a glassy state in which vortices are practically immobile as long as the applied current density is smaller than J_c . Some important steps in this direction have been made with the experimental realization and theoretical explanation of the *Bose glass* state formed by columnar defects, which provides the strongest pinning as a result of the geometrical match between the sizes of the cylindrical defects and of the vortex core. For example, Figure 9 shows the substantial enhancement of the J_c that can be achieved in technologically useful YBCO-coated conductors by the practical and cost-effective method of adding BaZrO₃ (BZO) nanoparticles, which generate linear defects. Other pinning enhancement methods, such as the replacement of Y by rare-earth combinations or the manipulation of the roughness at the superconductor-buffer interface, have been demonstrated successfully. New strategies for generating periodic arrays of correlated defects using self-assembly or for including magnetic particles could lead to further enhancement of the pinning force.

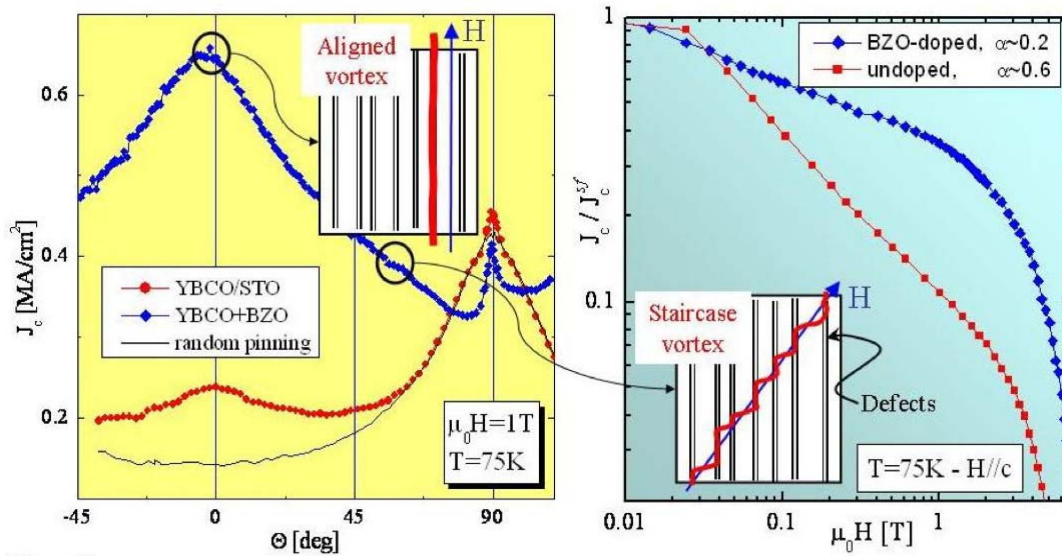

Figure 9 Left panel: J_c at 75 K and magnetic field $\mu_0 H = 1$ T for YBCO films grown by PLD, as a function of the angle Θ between H and the c -axis. The undoped film (red circles) exemplifies the usual three contributions to vortex pinning: (1) random point-like disorder (black line); (2) additional broad c -axis peak at $\Theta = 0^\circ$ arising from correlated pinning along the c -axis, mostly as a result of dislocations; and (3) additional narrow ab-plane peak at $\Theta = 90^\circ$ arising from ab-correlated and intrinsic pinning. Engineering of pinning structures by addition of BZO nanoparticles results in a strongly improved J_c (blue diamonds), mainly as a result of additional correlated pinning from c -axis dislocations growing from the nanoparticles. The sketches show the structure of the pinned vortices for $H \parallel c$ (magnetic field parallel to the c -axis) and for a tilted orientation. Right panel: The deterioration of J_c with magnetic field, which is described by the power law $J_c \sim H^{-\alpha}$, is strongly reduced by the BZO additions, with α decreasing from ~ 0.6 to ~ 0.2 (for $H \parallel c$).

A puzzling vortex pinning phenomenon that is peculiar to YBCO is the thickness dependence of J_c . Simply expressed, the best-quality YBCO films available today exhibit a J_c that decreases with film thickness. This means that efforts to increase the overall current-carrying capability by increasing the film thickness (i.e., the conductor cross section) provide diminishing returns. This qualitative behavior appears to be universal, for reasons that are poorly understood at best. One elegant solution to the thickness-dependence problem in PLD coatings is the synthesis of multilayer structures (see Figure 10). The method has yet to be demonstrated in long lengths of continuously produced coated conductors, and, as presently used, it cannot be implemented in ex-situ processes. The problem of thickness dependence is another area that requires significant innovative research to enable cost-effective implementation of many superconductive technologies.

Limits of Current-carrying Capability. Recently there has been significant progress in research on enhancing vortex pinning and critical current in high-temperature superconducting wires. The key question that must be answered is this: How much further can we go? A fundamental limit is set by the depairing current density, J_0 . At this threshold current density, the kinetic energy of the Cooper pairs reaches the superconducting gap energy, and superconductivity is destroyed. J_0 decreases with increasing temperature, as shown in Figure 11 (right panel) for the particular case of YBCO. To put in perspective the presently attainable J_c values, it is useful to compare J_c at $H = 0$ with J_0 . Observed ratios of J_c/J_0 range from $\sim 10^{-6}$ to as high as ~ 0.1 to 0.2 in low-temperature superconducting wires, such as NbTi and Nb₃Sn, whose pinning properties have been improved by decades of research. Remarkably similar values have been obtained already in YBCO very thin films and coated conductors, as seen in Figure 11 (right panel). No fundamental barriers to higher J_c/J_0 ratios are presently known; indeed, simple theoretical estimates for optimal columnar defects give J_c/J_0 ratios of ~ 1 . However, J_c/J_0 ratios above ~ 0.1 – 0.2 have not yet been achieved.

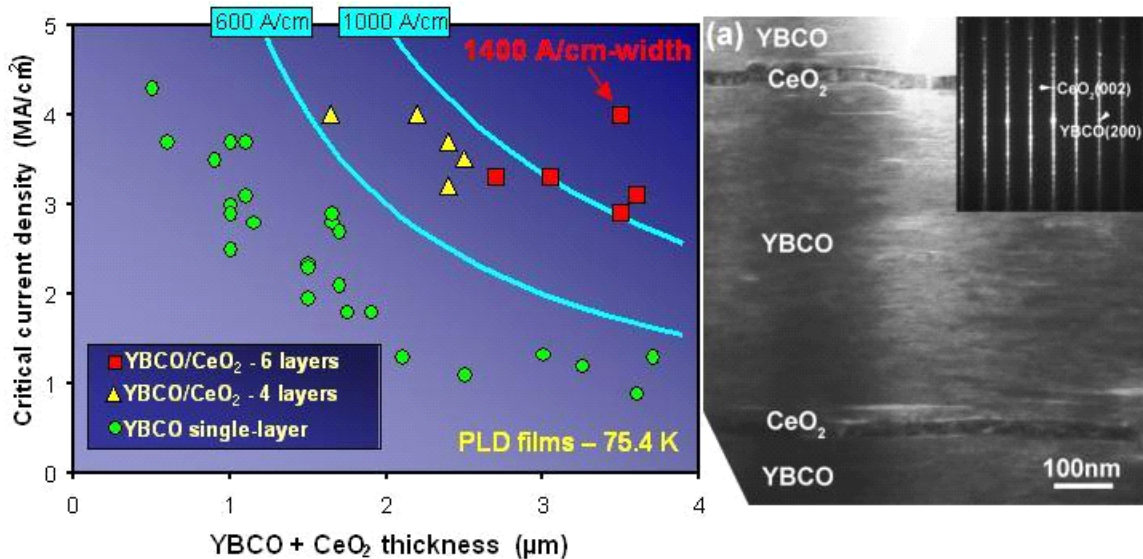

Figure 10 Left panel: The green circles show the J_c at 75 K and self-field for YBCO films grown by PLD on IBAD MgO templates. They exhibit the usual decay of J_c with thickness, common to all YBCO film deposition methods (in-situ and ex-situ). A solution to the thickness-dependence problem is to separate multiple YBCO layers with thin nonsuperconducting interlayers (such as CeO₂ or Y₂O₃), as shown in the right figure for several (YBCO/CeO₂)_N multilayers (yellow triangles, $N = 4$; red squares, $N = 6$). Record values of I_c per unit width in coated conductors (~ 1400 A/cm at 75 K) have been achieved with this method. Right panel: TEM image of a YBCO/CeO₂ multilayer (YBCO layer thickness is ~ 0.6 μm , CeO₂ layer thickness is ~ 30 nm).

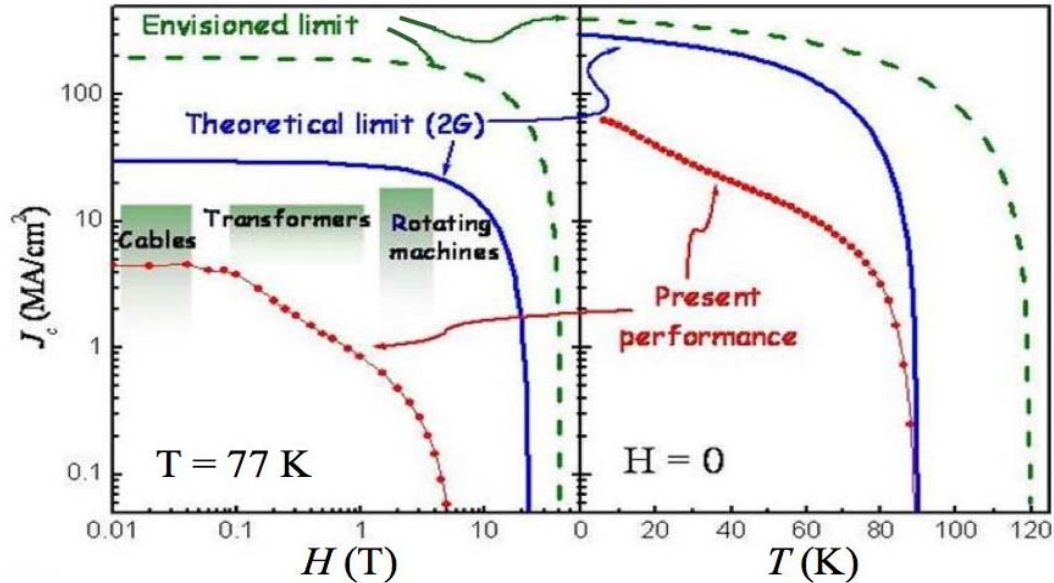

Figure 11 Left panel: Magnetic field dependence of J_c in a high-quality YBCO-coated conductor, at the benchmark temperature of 77 K, the boiling point of liquid N₂ (red dots). The requirements for devices (green boxes) clearly exceed present performance at this temperature. The solid blue line is the highest possible J_c that could be achieved in YBCO based on fundamental physical limits. Nanoengineering of the vortex pinning landscape could result in a revolutionary increase of performance by a factor of 5–10, up to this limit. The dashed green line is the theoretical limit for J_c attainable in a hypothetical next-generation superconducting wire with $T_c = 120$ K. Right panel: The temperature dependence of J_c at zero magnetic field.

The in-field performance limit in an applied magnetic field illustrated in the left panel of Figure 11 is somewhat idealized, since it would require a distinct optimal flux-pinning defect array *at each field*. Moreover, the important consideration of vortex creep — as discussed above — has been neglected, and it may further suppress the high in-field J_c values. This suppression is strongly influenced by the intrinsic material anisotropy. A realistic theoretical limit for the in-field J_c is as yet unknown.

The critical current limits of present materials underscore the need and opportunity to discover and control the defect nanostructures that, in real 2G conductors, could lead to improved performance and economic viability. Even in the case of superconducting cables, for which present properties overlap with the projected operational range, there is impetus for significant improvement. Power cable applications necessitate operation of the 2G wire in alternating magnetic fields of peak amplitudes indicated in Figure 11. The flat geometry of existing 2G tape (see panel survey on “Basic Research Challenges for Applications”), which precludes the formation and twisting of fine filaments, exacerbates alternating-current (ac) losses and leads to magnetic hysteresis energy losses that vary approximately as the ratio of operating current to critical current, $(I/I_c)^4$. For this reason, at a target operating ac amplitude, I , technical achievements that increase the maximum critical current, I_c , will also provide significant reductions in ac energy losses.

A key conviction of this panel is that a fivefold to tenfold increase in J_c is a realistic, high-impact goal to be pursued, together with finding the maximum current density that can be achieved in large magnetic fields. These discoveries will have a major impact on applications of superconductivity and constitute a major component of a priority research direction (PRD). The ubiquitous presence of vortices, together with the overriding importance of understanding how they interact with one another and with pinning centers, motivates a corresponding theoretical focus in the PRDs.

Pinning the Vortex Liquid. Extending the useful region of vortex glassy states to higher temperatures and magnetic fields remains a very high priority. One approach to extend the glassy state is to introduce a high density of columnar defects to pin each vortex in the liquid state. However, recent work on vortex pinning by dilute columnar defects suggests an upper limit to this prospect, due to the loss of vortex line tension above a certain temperature and field. The loss of line tension corresponds to the disintegration of vortex lines into 2-D pancakes that can no longer be pinned as a result of large thermal fluctuations. To compete with thermal energies, new schemes are needed for very strong pinning energies provided through artificially engineered nanodefects and/or nanomagnetic pinning sites.

Vortex Phenomena: Static and Dynamic Phases

Structural Vortex Transitions. Understanding structural transitions between vortex lattices of different symmetries is important both from the fundamental point of view and from the applied perspective, because the symmetry of the vortex lattice affects the vortex melting line. It has been shown that in many superconductors (Nb, V₃Si, borocarbides, etc.), the vortex lattice can undergo transitions from triangular to rhombic to quadratic and then back to rhombic as the magnetic field increases. Such transitions are governed by competition between vortex repulsion and thermal fluctuations, which favors the triangular lattice, and by the weak interaction of the vortex lattice with the materials lattice, which imposes the underlying crystalline symmetry onto the vortex lattice. This interaction is a nonlocal effect observed in clean superconductors and is a manifestation of the Fermi surface geometry.

Amazingly rich static and dynamic vortex behaviors are observed in layered superconductors in a magnetic field tilted with respect to the Cu-O planes. For instance, composite crossing vortex lattices composed of Josephson vortices and pancake-vortex stacks have been predicted and observed. Other lattice structures include the so-called kinked lattices, coexisting lattices with different orientations, tilted vortex chains, and pancake-vortex chains connected by in-plane Josephson vortices (Figure 12). Different lattice configurations are typically separated by structural first-order phase transitions. The dynamic behaviors of these static phases are also very intriguing. The weak coupling between the Cu-O planes in the layered cuprates can lead to driven vortex phases. For example, voltage oscillations between Cu-O planes (the so-called Josephson plasma resonance) can arise and generate electromagnetic waves from moving vortices. Through the Josephson relation $V = \hbar\omega/2e$, these voltage oscillations correspond to electromagnetic radiation in the terahertz frequency range. The prospect of using vortices as a source of tunable monochromatic and coherent radiation in the terahertz frequency range is being actively explored, both experimentally and theoretically.

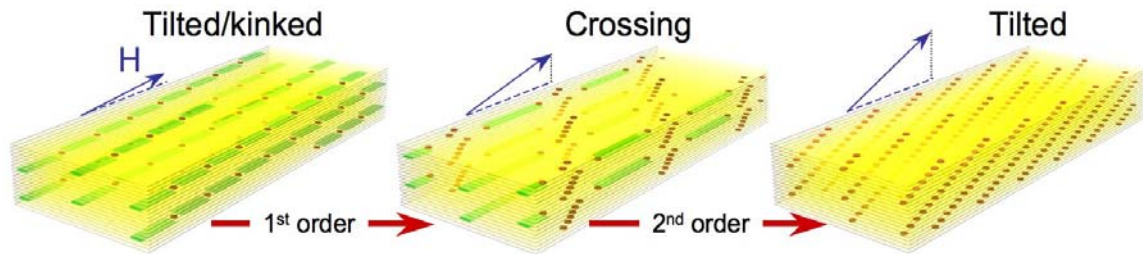

Figure 12 Theoretical predictions of novel vortex phases and transitions in highly anisotropic superconductors. The complex interaction between the 2-D pancake vortices and the Josephson vortices leads to a transformation from a tilted/kinked vortex state to a “crossing chains” state via a first-order transition, and then back to a “tilted chains” state through a second-order transition with increasing tilt angle of magnetic field. The first-order phase transition is accompanied by a large jump in the density of the pancake vortices. Understanding the dynamic response of these interacting vortex phases could open new frontiers in vortex manipulation.

New Opportunities Due to Two-band Superconductivity in MgB₂. The recent discovery of superconductivity at 40 K in MgB₂ has attracted much attention to the novel effects caused by the so-called “two-gap” superconductivity. MgB₂ has two groups of electrons, the π and σ electrons, that act almost independently of each other. Both groups of electrons go into a superconducting state, with two distinct superconducting pairing states coexisting in the same material. By selectively doping the materials with C, for example, the scattering between the π and σ electrons can be controlled, and upper critical field values in excess of 40 T can be achieved in films. These results make MgB₂ a very promising contender for high-field magnet applications in the temperature range of 20 to 25 K. Besides the enhancement of the upper critical field, the two-gap superconductivity in MgB₂ manifests itself in such peculiar phenomena as an intrinsic Josephson effect caused by tunneling between two weakly coupled groups of electrons; the composite structure of the superconducting vortex core, which consists of two different concentric cores defined by the respective sizes of the Cooper pairs in the π and σ electrons; and so-called “interband phase textures” caused by strong electric fields and currents. The theory of these effects is being developed and will provide new understanding of strong vortex pinning and high critical currents in MgB₂. Likewise, the emerging understanding of the intrinsic interband phase textures is crucial not only for new features of MgB₂ Josephson junctions but also for the general theory of the nonequilibrium microwave response of MgB₂ in strong electromagnetic fields. This theory is needed to describe the superconducting cavities used in high-energy particle accelerators or free electron lasers.

Microscopic Theory of the Vortex Core. The vortex core constitutes an interesting and important new subject of research in light of the new classes of superconductors discovered in recent years, which exhibit unconventional pairing or multiple gaps. The vortex core can display intricate microstructures. These microstructures (such as those shown in Figure 13a for NbSe₂) are related to the underlying Fermi surface of the material. Normal-state electrons are confined within the vortex core since the superconducting (SC) gap, Δ , prevents them from penetrating into the body of the superconductor. The confinement gives rise to discrete electron levels, the so-called Andreev states, analogous to the quantum states of a particle in a box (Figure 13b). When a vortex moves under an applied current, it drags these Andreev electrons, which thus acquire additional momentum. At the same time, according to Faraday’s law, the moving vortex generates an electric field which accelerates the normal electrons, throwing them eventually over the Δ -barrier. Thus, Andreev electrons leave the core and dissipate their momentum in the body of the superconductor. This is the mechanism of vortex friction. Vortex friction is not yet well understood in unconventional superconductors and complex core shapes.

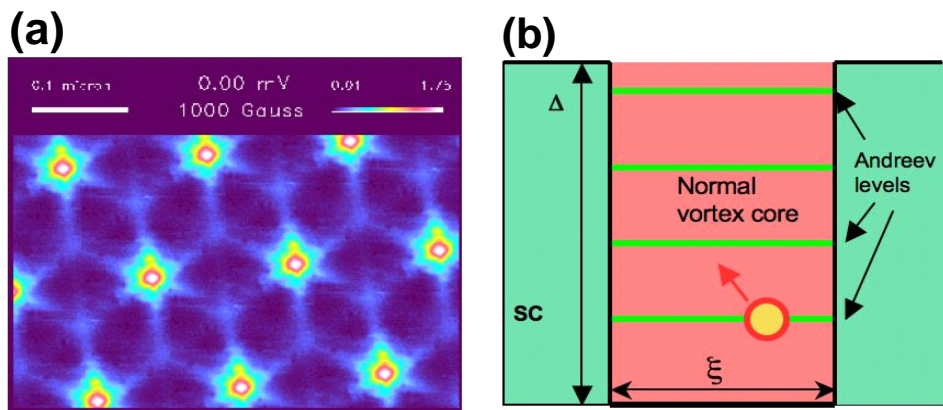

Figure 13 (a) Scanning tunneling microscopy (STM) image of the microstructure of vortex cores in NbSe₂ (H. Hess, *Phys. Rev. Lett.* **62**, 214 [1989]). (b) Schematic of normal electron (Andreev) levels within the vortex core.

Vortex Properties of Yet-to-Be-Discovered Superconductors

It is instructive to consider what vortex pinning and dynamics properties should be expected in a hypothetical higher- T_c superconductor. The key issue is that, in standard weak-coupling theory, the coherence length ξ is inversely proportional to v_F/T_c , where v_F is the electron velocity. Thus, the higher the T_c , the smaller the ξ (for similar electronic structure). For instance, a room-temperature superconductor is expected to have ξ smaller than 1 nm. Two positive consequences of this relation are that both H_{c2} and J_0 should increase proportionally to T_c . The negative aspect is that the effect of thermal fluctuations would increase dramatically with increasing T_c (roughly as T_c to the fourth power), producing a reduction in H_{irr} and an increase in the vortex creep rate. The other relevant parameter of the hypothetical higher- T_c superconductor would be its anisotropy. A large γ would further exacerbate the thermal fluctuations problem, probably rendering even a room-temperature superconductor ineffective for power applications (although it would certainly revolutionize condensed matter physics).

The ideal high-temperature superconductor would have nearly isotropic properties, such as those of the cubic-structured low-temperature superconductors. As illustrated in Figure 11, for a hypothetical isotropic material with a T_c of ~ 120 K, the theoretical limit would provide a markedly large J_c operating margin, such that virtually all new applications should be easily accommodated at 77 K. Such new materials, coupled with optimized flux-pinning nanostructures, could lead to revolutionary simplification and performance in future generations of superconducting wires.

Finally, because any new superconductor with a similar or higher T_c than cuprate high-temperature superconductors is likely to have similar or smaller ξ , the effective vortex pinning structures will also be nanoscaled. Thus, any progress made in the field of vortex phenomena in cuprate superconductors, both in the fundamental understanding of vortex pinning and dynamics and in the nanoengineering of pinning landscapes, will likely be also relevant to future improved materials.

SCIENTIFIC CHALLENGES

The response of vortex matter to applied current, magnetic field, temperature, and disorder has direct implications for the technological viability of superconducting materials. Understanding and controlling vortex matter behavior involves many basic science challenges. One of the most fundamental is the full quantitative description of vortex motion in the glassy vortex state, where the pinning energy landscape is a complex network of deep valleys and ridges. Such complicated landscapes are typical of commercial superconducting wires. Although our understanding of vortex matter has increased greatly since the discovery of the high-temperature superconducting cuprates, our understanding of materials with complex vortex pinning landscapes is limited. Vortex pinning in such landscapes involves several length scales (point and correlated defect pinning, coherence-length-related core pinning, and penetration-length-related magnetic pinning). Preventing vortex creep across such landscapes at high temperatures will be a major scientific challenge. Devising new methods for pinning the vortex liquid state or shifting the irreversibility line of the cuprates to higher temperatures and magnetic fields is another significant challenge. Overall progress on vortex phenomenology undoubtedly will result from intertwined theoretical and experimental efforts. At the deepest level, we need a change in the paradigm, from the concept of vortex pinning of individual defects to the idea of a continuous vortex energy landscape (see sidebar, “Changing the Paradigm”).

CHANGING THE PARADIGM: FROM PINNING DEFECTS TO VORTEX ENERGY LANDSCAPE

Present models that describe vortex pinning (left panel of figure) have a relationship to the real vortex pinning landscape in state-of-the-art coated conductors (right panel) similar to the relationship of a child's attempted drawing to a photograph. Existing pinning models are highly idealized. They usually consider a single type of defect, with sharp boundaries, immersed in a perfect, "empty" superconducting matrix. These models have been very successful in describing the behavior of clean single crystals with well-defined morphology and a density of defects introduced in a controlled way, but they are not powerful enough to allow a quantitative calculation of J_c in technologically relevant, high-temperature superconductors, which contain continuous vortex energy landscapes with different types of defects at several length scales, and no sharp boundaries.

To attack this much more complex problem, we need new and improved tools in order to identify three-dimensional (3-D) continuous structural variations (e.g., strain or oxygen content) and quantitative correlations between those variations and the superconducting parameters, combined with new, more powerful dynamic and 3-D vortex imaging. In addition, we need to take vortex pinning and motion modeling to its next level, to explore continuous energy landscapes. This will require a combination of theory, computation, and experimental studies in model systems.

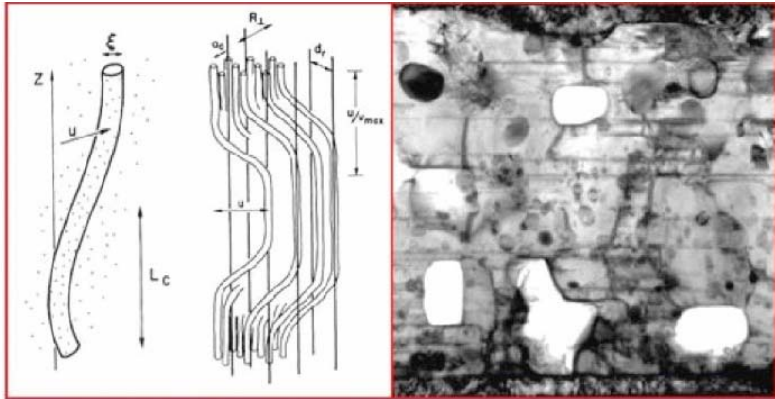

Some specific research challenges include these:

- Developing a theory to address glassy vortex response to an ac electromagnetic field. The time evolution of the glassy vortex state results in an aging process (change in dynamic properties with time) and memory effects (dependence of dynamic response to the history of the external field). These properties are critical for the description of ac response in commercial superconductors.
- Developing a microscopic theory of vortex pinning.
- Understanding vortex pinning behavior across various interfaces and dislocations.
- Developing new methods to enhance vortex pinning and thereby increase the critical current density up to the theoretical limit set by fundamental physics.
- Unravelling the properties of cumulative pinning effects. The main problem is that pinning is not additive. It may be possible to artificially engineer various types of disorder that are effective at different magnetic fields or temperatures.
- Arresting thermal instabilities (avalanches) and fluctuations in complex disordered systems.
- Understanding the vortex electrostatics at extremely high supercritical currents. This will be required in superconducting fault current limiters.

- Designing self-assembled nanoscale periodic pinning arrays to realize a high-density, one-to-one vortex pinning scheme.
- Devising magnetic pinning schemes that capture a larger fraction of the energy of a vortex, by using defects that are ferromagnetic.
- Developing the next generation of imaging tools (such as Lorentz microscopy, three-dimensional holograph microscopy, environmental scanning tunneling microscopy [STM], and magnetic force microscopy [MFM]) to observe and study single vortex pinning on a site-specific defect.

IMPACT

Major advances in our understanding of vortex behavior will directly affect the commercial and industrial implementation of superconducting wires for electric distribution. This research is critical to the development of increased current-carrying capacity and to the generation of high magnetic fields using these wires. These improvements promise to lead to a tipping point, where superconductivity becomes a feasible technology for distributing electricity throughout the United States and enabling “smart” electric transmission with high current capacity at low cost.

REFERENCES

- G. Blatter, M.V. Feigel'man, V.B. Geshkenbein, A.I. Larkin, and V.M. Vinokur, “Vortices in High Temperature Superconductors,” *Rev. Mod. Phys.* **66**, 1125 (1994).
- V. Braccini et al., “High Field Superconductivity in Alloyed MgB₂ Thin Films,” *Phys. Rev. B* **71**, 012504 (2005).
- L. Civale, A. Marwick, T. Worthington, M. Kirk, J. Thompson, L. Krusinbaum, Y. Sun, J. Clem, and F. Holtzberg, “Vortex Confinement by Columnar Defects in YBa₂Cu₃O₇ Crystals: Enhanced Pinning at High Fields and Temperatures,” *Phys. Rev. Lett.* **67**, 648 (1991).
- J. Figueras, T. Puig, X. Obradors, W.K. Kwok, L. Paulius, G.W. Crabtree, and G. Deutscher, “The Loss of Vortex Line Tension Sets an Upper Limit to the Irreversibility Line in YBa₂Cu₃O₇,” *Nature Physics* **2**, 402 (2006).
- S.R. Foltyn et al., “Overcoming the Barrier to 1000A/cm Width Superconducting Coatings,” *Applied Physics Letters* **87**, 162505 (2005).
- S.R. Foltyn et al., “Strongly Coupled Critical Current Density Values Achieved in Y₁Ba₂Cu₃O_{7-δ} Coated Conductors with Near-single-crystal Texture,” *Applied Physics Letters* **82**, 4519 (2003).
- A. Gurevich, “Enhancement of the Upper Critical Field by Nonmagnetic Impurities in Dirty Two-gap Superconductors,” *Phys. Rev. B* **67**, 184515 (2003).
- T. Haugan et al., “Addition of Nanoparticle Dispersions to Enhance Flux Pinning of the YBa₂Cu₃O_{7-x} Superconductor,” *Nature* **430**, 867 (2004).
- A.E. Koshelev and V.M. Vinokur, “Dynamic Melting of the Vortex Lattice,” *Phys. Rev. Lett.* **73**, 3580-3583 (1994).

D. Larbalestier, A. Gurevich, D.M. Feldmann, and A. Polyanskii, "High- T_c Superconducting Materials for Electric Power Applications," *Nature (London)*, **414**, 368 (2001).

D. Larbalestier et al., "Strongly Linked Current Flow in Polycrystalline Forms of the Superconductor MgB_2 ," *Nature (London)*, **410**, 186 (2001).

J.L. MacManus-Driscoll et al., "Strongly Enhanced Current Densities in Superconducting Coated Conductors of $YBa_2Cu_3O_{7-x} + BaZrO_3$," *Nature Materials* **3**, 439 (2004).

D.R. Nelson and V.M. Vinokur, "Boson Localization and Correlated Pinning of Superconducting Vortex Arrays," *Phys. Rev. B* **48**, 13060 (1993).

Special edition, "Superconductivity in MgB_2 : Electrons, Phonons and Vortices" (W. Kwok, G. Crabtree, S.L. Bud'ko, and P.C. Canfield, Eds.), *Physica C* **385**, Nos. 1-2, (1 March 2003).

Special issue, "High Performance YBCO-coated Superconducting Wires" (M.P. Paranthaman and T. Izumi, Eds.), *MRS Bull.* **29**(8), August 2004.

V. Vinokur, "Glassy Dynamics of Driven Elastic Manifolds," *Physica D* **107**, 411-420 (1997)

Y. Yeshurun, A.P. Malozemoff, and A. Shaulov, "Magnetic Relaxation in High-Temperature Superconductors," *Rev. Mod. Phys.* **68**, 911 (1996).

See presentations in DOE *Superconductivity for Electric Systems Annual Peer Reviews and Wire Development Workshops* at:

<http://www.energetics.com/supercon04.html>. - <http://www.energetics.com/wire05.html>.

<http://www.energetics.com/supercon05.html>. - <http://www.energetics.com/wire06.html>.

BASIC RESEARCH CHALLENGES FOR SUPERCONDUCTIVITY THEORY

The discovery of high-temperature superconductivity in the cuprates represents a grand challenge for theory to explain. Significant progress has been made, and a number of principles common to many of the suggested theories of these materials have emerged. Nevertheless, an accepted theory of high- T_c superconductivity still eludes us; it will likely result in a Nobel Prize if and when such a theory is developed. Here, rather than survey the large body of proposed theories, we discuss a number of the common questions and themes that are central to theories of superconductivity and superconductors.

THE THEORY OF BARDEEN, COOPER, AND SCHRIEFFER: A SUCCESS STORY WITHOUT RIVAL

Very few theories in modern physics can explain experimental phenomena across 10 or more orders of magnitude in energy scales. The Bardeen, Cooper, and Schrieffer (BCS) theory of superconductivity is such a theory. The theory works over a vast range of systems, from a very small scale (nuclei) up to a very large scale (neutron stars), with many systems in between. The framework developed by John Bardeen, Leon Cooper, and J. Robert Schrieffer was, after all, intended to answer a seemingly pedestrian question: Why is it that if we immerse a piece of common metal, such as Pb, Al, or Hg, in liquid He (see Figure 14), we cannot measure any trace of resistance? The answer to this apparently benign question eluded Albert Einstein, Felix Bloch, Werner Heisenberg, and others of their caliber for more than four decades. The BCS landmark paper, which was published in 1957, sheds light on these previous failed attempts. The methods of modern many-body theory, necessary for a proper treatment of the interaction between electrons and the lattice, had not been developed until then. Similarly, the framework and theoretical constructs that BCS provided have subsequently driven other fields.

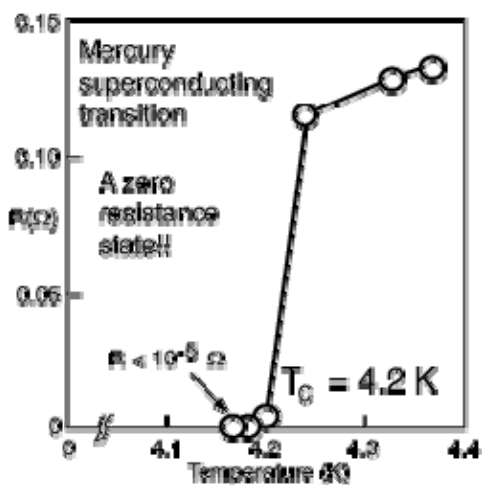

Figure 14 The resistive transition of mercury, as discovered by Kamerlingh-Onnes in 1911.

THE SUPERCONDUCTING STATE: A COHERENT STATE OF PAIRED ELECTRONS

The concepts of *pairing* and *coherence* (see sidebar, “Basics of Superconductivity: BCS Theory”) are the theory’s foundation, and their relevance to astro-, condensed-matter, nuclear, and high-energy physics demonstrates the utility of BCS theory with regard to vastly different systems. Here we first discuss the concept of a *coherent electronic state* in a metal. The basic observation is that in the superconducting state, *all* mobile electrons (carriers of charge) participate in the *same* ordered state and move in a highly coordinated fashion, just as soldiers march together in a parade (see Figure 15). This is in stark contrast to the lack of such order in the electronic states of a normal metal. The unusual properties of a superconducting material are direct consequences of this so-called *long-range order*. As it turns out, impurities causing resistance will not be able to disrupt the long-range order of the electrons, unless the current flow exceeds a critical (sample- and material-dependent) magnitude. The presence of this

BASICS OF SUPERCONDUCTIVITY: BCS THEORY

The Bardeen, Cooper, and Schrieffer (BCS) theory has two main conceptual ingredients: pairing of electrons and coherence. The two figures at the top illustrate the latter concept. Suppose we have a bumpy landscape and a large number of small balls spread over this landscape. Applying the same force to all the balls will move some of them, but not the others, and those that move will stick in some pothole. However, if we connect all the balls in one big, rigid object, this object will move just as well over the bumpy landscape as it would over a smooth one.

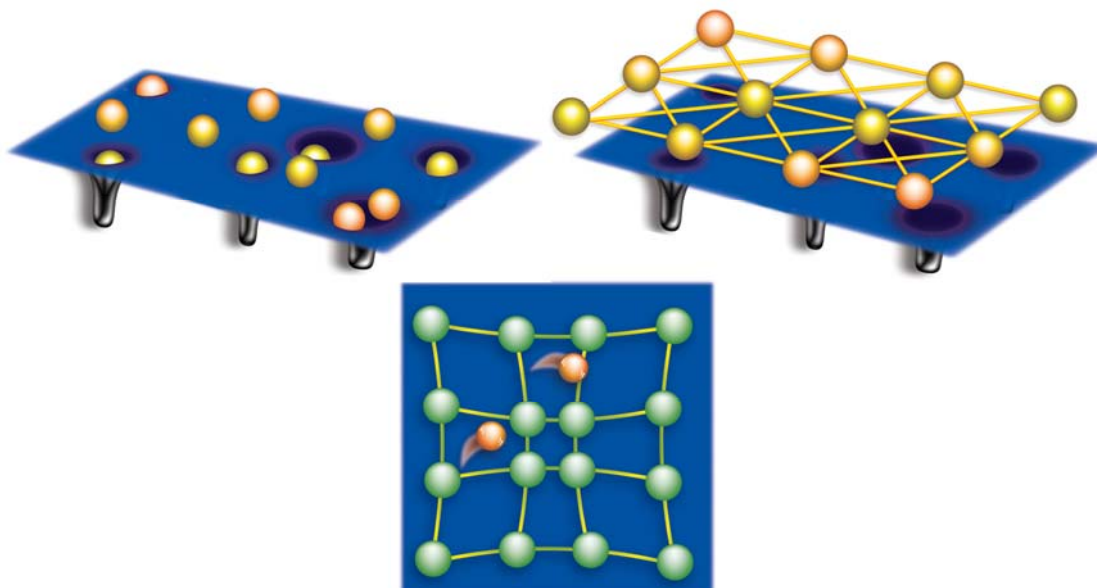

It turns out that this macroscopic coherence of microscopic quantum objects (the electrons) is possible only if the electrons are glued into pairs and if the pairs mutually overlap. The bottom figure illustrates the idea of electronic pairing by lattice vibrations. Ions in a metal are positively charged, and the mobile electrons have a negative charge; therefore, ions around an individual electron are attracted to it, creating a more concentrated positive charge around the electron. Because an electron moves so much faster than an ion, by the time the slow ions complete their travel toward the electron, the electron has already left this area, leaving behind the cloud of displaced ions with their net positive charge. Of course, when the ions realize that they were being attracted to an object that is no longer there, they start moving back to their original locations. However, this takes time. Within this time, another electron can be attracted to this cloud of positive charge. If the time scales are properly tuned, the second electron can trace the path of the first one, following it around the crystal. In such a situation, we say that the electrons have formed a "Cooper pair."

dissipationless *supercurrent* also produces the spectacular Meissner-Oschenfeld effect: A superconductor expels an external magnetic field, provided that this field is smaller than some critical value. One of the most amazing consequences of this magnetic field expulsion is superconducting levitation.

But part of the puzzle is still missing. Since the landmark papers of Nobel laureate Wolfgang Pauli were published, we know that two electrons (let alone all of the 10^{23} electrons found in a typical piece of aluminum metal) cannot occupy the same quantum mechanical state. How is it possible that such a coherent electronic state required by superconductivity nevertheless forms in a metal, where the only mobile charge carriers are the electrons themselves? The answer is found by introducing the concept of pairing, following Leon Cooper's original idea in 1956: Provided that the electrons *pair*, one can circumvent the restrictive Pauli exclusion principle valid for *single* electrons and allow for electron *pairs* (see Figure 16) to form a coherent, ordered state.



Figure 15 The contrast between the normal and superconducting state of electrons is somewhat similar to the disordered crowd (left panel) and the highly coordinated motion of marching soldiers (right panel).

THE GLUE THAT HOLDS ELECTRON PAIRS TOGETHER

As is apparent from Figure 14, the temperature at which Hg becomes a superconductor is very, very low — just a few degrees above absolute zero. Clearly, one of the most intriguing questions to ask is how to raise the T_c at which these macroscopic quantum phenomena start to appear in a superconducting material. After all, there are several *ordered* states (e.g., the ferromagnetic state in magnets) that maintain their quantum coherence to room temperature and beyond. Why is it that the superconducting state disappears at much lower temperatures? In order to answer this question, we need to know what the *glue* is that binds the two electrons into a pair, despite the fact that the electrons are charged and, as such, repel each other. Bardeen, Cooper and Schrieffer demonstrated that the *glue* in conventional superconductors derives from lattice vibrations. Indeed, lattice distortions created by one electron would attract the second (see sidebar, “Basics of Superconductivity: BCS Theory”), and in this way, the lattice can mediate an *effective* attractive interaction between electrons despite the Coulomb repulsion.

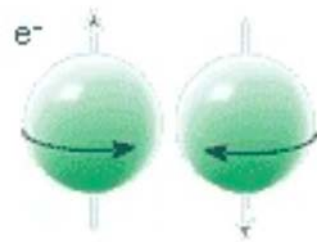

Figure 16 It takes two to tango in a superfluid electron state. Electron *pairs* (of opposite spin) can condense into a single macroscopic coherent state capable of exhibiting flow without resistance and expelling an external magnetic field in a superconductor.

RAISING T_c : THE SEARCH FOR A DIFFERENT “GLUE” FOR ELECTRON PAIRS

Once the glue has been identified, it is much easier to see if the T_c can be tuned to higher values. In fact, the BCS theory provides an explicit expression for T_c in terms of the “strength” of the glue, λ , and its characteristic temperature (or energy), T_D . (In conventional superconductors, these are lattice vibrations, also known as phonons.)

$$T_c \propto T_D e^{-1/\lambda} .$$

CONVENTIONAL AND UNCONVENTIONAL PAIRING SYMMETRY

When one electron feels the polarization of the ionic lattice induced by another electron, this creates an effective interaction between these electrons. In the simplest model, this interaction is always attractive and isotropic in space. Thus, the resulting electron pair has the highest possible symmetry, known as s-wave. In s-wave symmetry, the probability of finding a second electron in the neighborhood of the first depends only on the distance between the two electrons and not on the directional orientation of the pair. In more sophisticated models, in particular, when not only the electrostatic polarization of the ions but also the magnetic polarization of the electrons are taken into account, the net interaction becomes more complicated. This interaction can be attractive for some locations of the electrons and repulsive for others. Correspondingly, more complex pairs form, where the motion of the electrons is correlated in a more complicated way. Such non-s-wave pairs form in the high- T_c cuprates and also in some other superconductors that are denoted as being unconventional. The figures below show the probability of finding an electron in a Cooper pair, assuming the other electron is at the origin in a conventional (s-wave) superconductor (left) and in an unconventional superconductor (right), the example in this latter case being for an f-wave state.

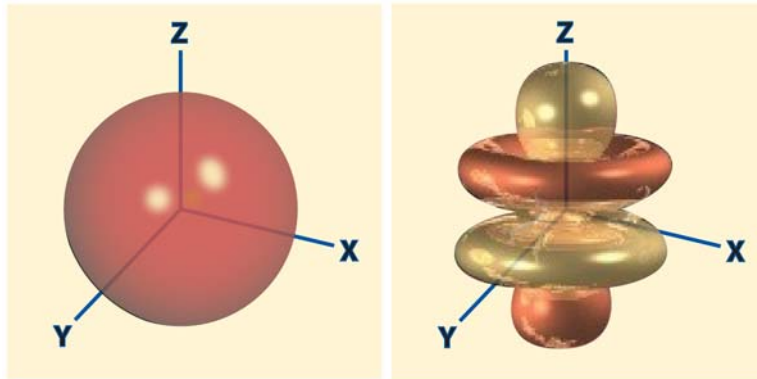

The maximum possible transition temperature cannot be higher than this scale, and in reality, the exponentially small coupling, $e^{-1/\lambda}$, strongly reduces the actual values of T_c . Indeed, within the class of lattice-mediated superconductors, the progress toward higher critical temperatures has been relatively slow. The recent discovery of MgB_2 with a T_c of ~ 40 K is a striking counterexample. Its near-doubling of T_c , compared to other lattice-mediated superconductors demonstrates that further progress is still possible. But the discovery of high-temperature cuprate superconductors that sent T_c skyrocketing fueled suspicion that the energy scale of the glue needed for such high values of T_c might originate from the electrons themselves, as opposed to the lattice of ions.

THE SEARCH FOR FUNDAMENTAL LIMITS IN CRITICAL TEMPERATURES

The history of superconductivity is full of surprises and unexpected discoveries. It would be natural to expect similar positive surprises in the future. Researchers expect a high transition temperature and robust superconducting state in a number of materials yet to be discovered. This naturally raises the question, “What, if any, are the fundamental limitations imposed by nature on the superconducting transition temperature?” We know that this ordered state inherits some of its typical temperature and energy scales from the normal metallic state. Hence, it is natural to suspect that the underlying temperature/energy scales of the normal state will dictate how high the transition temperature can be. It is therefore a good idea to look at materials that exhibit large underlying energy scales. A prime example is the cuprates: oxides that exhibit unusually strong magnetic interactions with a dominant energy scale for the exchange interaction between the Cu electrons around 1,500 K. These oxides are the parent compounds of the highest- T_c superconductors known to date. When doping the insulating “parents” with mobile charge carriers, several research groups documented T_c ’s as high as 140 K (see Figure 17). Many of the different

classes of materials that we are investigating today exhibit large energy scales in ways that are qualitatively different from those of the class of cuprate superconductors. We should therefore be optimistic that different classes of materials have the potential to become superconductors under ambient conditions with potentially high critical temperatures.

LOOKING FOR DIFFERENT GLUE

There are no simple and straightforward directions on how to create new classes of superconductors. All families of superconductors known to date were discovered serendipitously. However, this does not need to be the case in the future, and we can point out some likely possibilities where breakthroughs could occur. We now know that a large energy scale can sometimes be translated into a high critical temperature. This is an important ingredient. On the other hand, the exact nature of the glue is not as important. Here are a few possibilities for gluing pairs and creating a superconducting state: (a) lattice vibrations (with the negative electrons being attracted to the positive ions), (b) spin fluctuations (where pairs are bound because of magnetic interactions between the electrons' spins), and (c) valence fluctuations (where local valence changes on an ion attract two electrons to form a pair). This list can be continued, and it is important in our search for novel superconductors to cast the net broadly enough to be able to capture wide classes of materials and mechanisms. While we are searching for new mechanisms of superconductivity with higher transition temperatures, it is also important to keep the theoretical discussion broad. Some materials that have apparently low transition temperatures (such as the heavy fermion or organic superconductors) have opened the door to new understanding of broader issues in materials physics. And truly “high-temperature” superconductivity (such as that proposed for neutron stars) might guide us to find new superconductors on our own Earth (see Figure 18).

Clearly, we need to pay attention to all novel superconductors, regardless of their transition temperature and mechanism. In the past 20 years, we have seen many shattered theories and predictions of how high the transition temperature can be. Indeed, the MgB_2 superconductor seems to have the conventional “phonon” (lattice vibration) mechanism of superconductivity but with a very high T_c of 40 K. This is a good example of the positive surprises one might expect as we move forward in our theoretical search for novel superconductors.

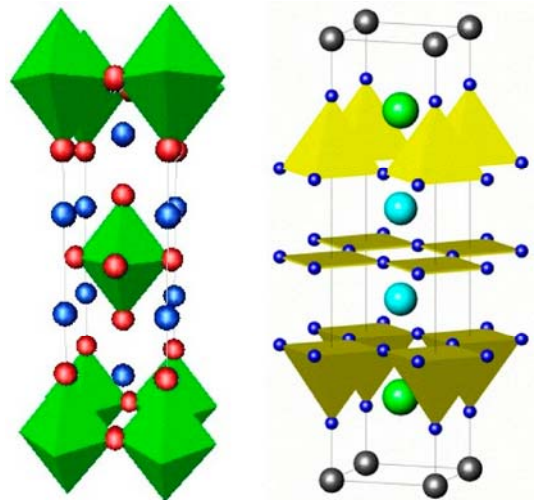

Figure 17 Crystal structure of the first high- T_c superconductor, $\text{La}_{2-x}\text{Sr}_x\text{CuO}_4$ (left), with a T_c of ~ 40 K, versus the record holder, $\text{Hg}_{0.2}\text{Tl}_{0.8}\text{Ca}_2\text{Ba}_2\text{Cu}_3\text{O}_8$, with a T_c of ~ 140 K (right) (cf. P. Dai et al., *Physica C*, **243**, 201 [1995]). Because the key ingredients (Cu-O planes) are the same in both materials, the huge 100 K difference must result from the optimization of energy scales in the Hg-based compound.

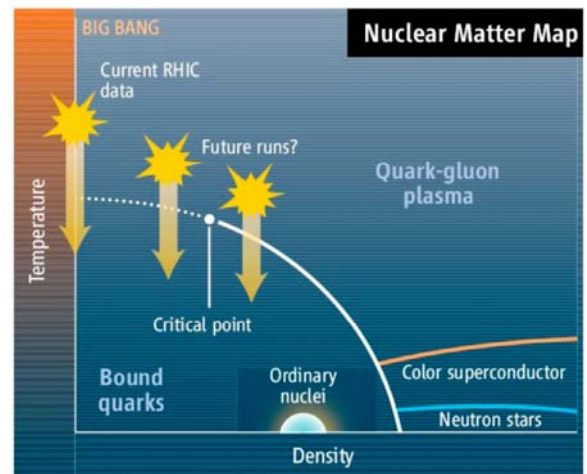

Figure 18 Ultra-high-temperature superconductors (like neutron stars) probably exist. The key theoretical and experimental question is whether they can be synthesized and stabilized under terrestrial conditions.

NEW TOOLS TO INVESTIGATE NOVEL SUPERCONDUCTORS

Last but not least, theory serves as a guide for and an interpreter of experiments. The search for novel materials and superconductors is intricately connected to our ability to elucidate, model, and predict properties of superconductors. We need to develop a suite of theoretical techniques to complement the rapidly developing field of new experimental probes, such as scanning tunneling microscopy (STM), optical conductivity, angle-resolved photoemission spectroscopy (ARPES), and inelastic neutron scattering (INS).

STRONGLY CORRELATED ELECTRONS IN HIGH-TEMPERATURE CUPRATE SUPERCONDUCTORS

Many of the theories of high-temperature cuprates follow the path of earlier studies of superconductors and assume some sort of “glue” that binds electrons together into Cooper pairs. This glue can be due to lattice vibrations, as for conventional superconductors, or it can be more exotic, such as the spin fluctuations proposed for superfluid helium-3 and heavy fermion metals.

In 1987, though, at the beginning of the study of cuprates, the Nobel laureate Philip Anderson proposed a novel idea for superconductivity. Standard band theory would predict that the parent cuprate material is a metal, but in reality, it is a so-called Mott insulator, with the insulating behavior driven by the strong Coulomb repulsion between the electrons. (It is for this concept that Sir Nevill Mott won the Nobel prize in 1977.) Mott insulators typically exhibit an antiferromagnetic ground state, known as a Néel lattice (top figure). But Anderson speculated that in some cases, perhaps in the cuprates, such a state would be unstable to quantum fluctuations that would drive the system into a novel state of matter, known as a spin liquid. He called this theory the resonating valence bond (RVB) theory, noting Nobel laureate Linus Pauling’s theory of organic compounds, which resonate between having single and double carbon bonds. In Anderson’s theory, Cu ions randomly form dynamic pairs with opposite spins (spin singlets), as shown in the middle figure. In reality, the undoped cuprates are now known to form a Néel lattice. But only a few percent of doped carriers are needed to destroy it. Whether the resulting doped state is a spin liquid is a much debated subject.

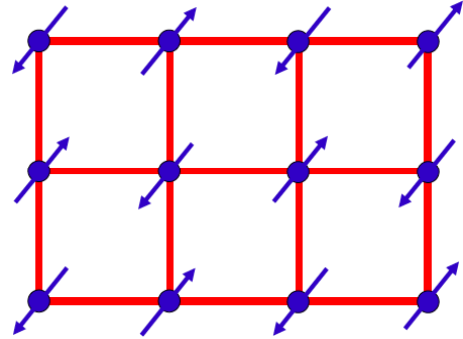

More importantly, it was shown shortly after Anderson’s proposal that such a doped spin liquid would be equivalent to a d-wave pairing of electronic spins; thus, it is a spin analogue of the BCS pair state. Moreover, at a low-enough temperature, these spins could recombine with the charge degrees of freedom of the electron and form a d-wave superconducting state. In fact, a phase diagram for the cuprates was conjectured early on (bottom figure) on the basis of this theory, and it is somewhat similar to that now observed by experiment, including a phase with gapped spin excitations that we now refer to as the “pseudogap.” Currently, this novel idea is also being explored for a variety of other materials, including heavy fermion metals, cobaltates, and organic superconductors. Recently, progress has been made by exploiting the connection of this theory to those used in describing the elementary particles of high-energy physics. One of the major challenges in theoretical physics today is to develop this theory to the level of rigor of the more conventional theories that were used in the past for superconductivity and to verify to what extent it is applicable to cuprates and high- T_c superconductivity.

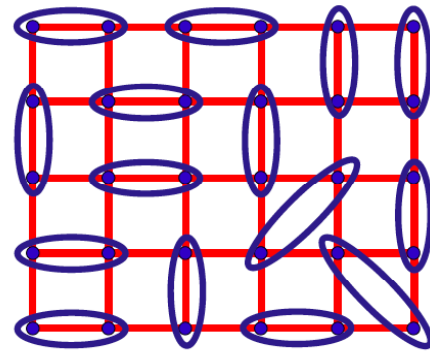

The jury is still out on whether this RVB theory is the right one for the cuprates. Regardless, it has had a major impact on the rewriting of textbooks on the theory of electrons in materials, and its ideas now permeate the field of quantum magnetism, with growing experimental evidence for spin liquids in various frustrated magnets.

The RVB idea discussed above, though, is only one example of the many models proposed in the context of high-temperature cuprates. Many other novel theories have been proposed, dealing with unique forms of charge order (checkerboards, stripes, nematics, and even crystalline versions of Cooper pairs), spin order (orbital currents, spirals, and flux phase states), and superconducting order (including a ghostly form known as gossamer superconductivity). Powerful new computational tools are also now available to attack this problem. These include quantum Monte Carlo algorithms, density matrix renormalization group, and dynamical mean field theory and its cluster extensions. These recently developed tools allow us to calculate a variety of experimental “observables” and the momentum- and energy-dependent pairing interaction and to determine the symmetry of the order parameter. All of these ideas have helped the community broaden its notion of emergent matter and its profound consequences.¹

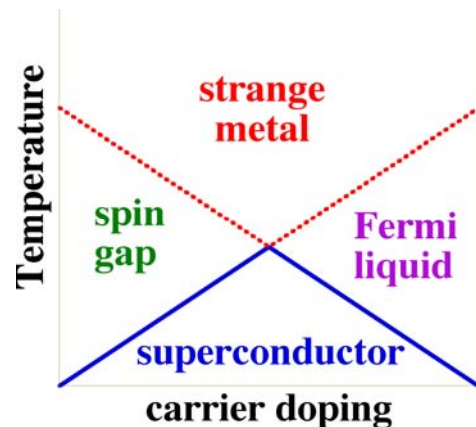

¹ A number of these ideas are discussed in greater detail in *Nature Physics* 2, 138 (March 2006).

REFERENCES

- P.W. Anderson, "Present Status of the Theory of the High T_c Cuprates," cond-mat/0510053, submitted to the V. Ginzburg commemorative volume, *J. Low Temp. Phys.*
- J. Bardeen, L.N. Cooper, and J.R. Schrieffer, "Microscopic Theory of Superconductivity," *Phys. Rev.* **108**, 162 (1957).
- E.W. Carlson, V.J. Emery, S.A. Kivelson, and D. Orgad, "Concepts in High-temperature Superconductivity," p. 275 in *The Physics of Superconductors, Vol. 2*, K.H. Bennemann and J.B. Ketterson (Eds.), Springer-Verlag, Berlin, Germany (2004).
- E. Dagotto, "Complexity in Strongly Correlated Electronic Systems," *Science* **309**, 257, 2005.
- V.L. Ginzburg, "Nobel Lecture, Sec. 3: On High-temperature and Room-temperature Superconductors," *Rev. Mod. Phys.* **76**, 981 (2004).
- R.B. Laughlin, G.G. Lonzarich, P. Monthoux, and D. Pines, "The Quantum Criticality Conundrum," *Adv. Phys.* **50**, 361 (2001).
- P.A. Lee and N. Nagaosa, "Doping a Mott Insulator: Physics of High-temperature Superconductivity," *Rev. Mod. Phys.* **78**, 17 (2006).
- A.J. Leggett, "What DO We Know about High T_c ?" *Nature Physics* **2**, 134 (2006).
- F. Marsiglio and J.P. Carbotte, "Electron-Phonon Superconductors," p. 233 in *The Physics of Superconductors, Vol. 1*, K.H. Bennemann and J.B. Ketterson (Eds.), Springer-Verlag, Berlin, Germany (2003).
- M. Norman, "A Magnetic Isotope Effect," *Nature Physics* **2**, 19 (2006).
- M.R. Norman and C. Pepin, "The Electronic Nature of High-temperature Cuprate Superconductors," *Rep. Prog. Phys.* **66**, 1547 (2003).
- W.E. Pickett, "Design for a Room Temperature Superconductor," cond-mat/0603482, submitted to the V. Ginzburg commemorative volume, *J. Low Temp. Phys.*; and "The Next Breakthrough in Phonon-mediated Superconductivity," cond-mat/0603428, submitted to the *Proceedings of the Notre Dame Workshop on the Possibility of Room Temperature Superconductivity* (June 2005).
- D.J. Scalapino, "The Case for $d_{x^2-y^2}$ Pairing in the Cuprate Superconductors," *Phys. Rep.* **250**, 329 (1995).
- M. Sigrist and K. Ueda, "Phenomenological Theory of Unconventional Superconductivity," *Rev. Mod. Phys.* **63**, 239 (1991).
- A.M.S. Tremblay, B. Kyung, and D. Senechal, "Pseudogap and High-temperature Superconductivity from Weak to Strong Coupling," *Low Temp. Phys.* **32**, 424 (2006).

BASIC RESEARCH CHALLENGES FOR NEW PHENOMENA

INTRODUCTION

Understanding the underlying principles of high-temperature superconductivity is a challenge whose complexity far exceeds that encountered with previous application-relevant electronic materials. Yet the rational design and creation of superconducting materials for energy applications require us to completely understand the special electronic ingredients that create a superconducting state at such high temperatures.

This challenge has proven daunting, especially in the context of the small scale on which electronic materials research has traditionally been carried out. On the other hand, the significance of the problem has also inspired a number of revolutionary experimental tools and approaches. Over the last 10 years, there has been unprecedented progress in the development of these techniques, including angle-resolved photoemission spectroscopy (ARPES), spectroscopic imaging-scanning tunneling microscopy (SI-STM), microwave/terahertz/infrared/optical spectroscopies, resonant and inelastic x-ray spectroscopy, high-intensity neutron scattering (NS), and nuclear magnetic resonance/nuclear quadrupole resonance/muon-spin relaxation (NMR/NQR/ μ SR).

The existence of these new techniques and capabilities represents a unique and exciting opportunity. A complete determination of all relevant electronic and magnetic susceptibilities (the electronic “genome”) of high-temperature superconductivity can now be achieved for the first time. The outcome should reveal the special electronic ingredients that create a high-temperature superconducting state. However, such an undertaking would rival astrophysical “sky surveys” or biological “genome mapping” in data volume and complexity. It could be achieved only with nationwide coordination, cooperation, and sustained support. Synergistic relationships that involve experimental research, innovative theoretical ideas and analysis schemes, the management of large volumes of data, and computational studies would also be required.

CURRENT STATUS

The discovery of superconductivity in layered copper oxide (CuO_2) compounds was remarkable, not only because of the high temperatures at which superconductivity survives, but especially because of the fact that these materials had been thought to be poor electronic conductors. The key components of these materials are the CuO_2 planes. Inorganic chemists have found a wide variety of spacer layers that can be inserted between the CuO_2 planes, resulting in a considerable number of different cuprate compounds that exhibit high-temperature superconductivity. For a given compound, the electronic properties of the CuO_2 , especially the superconductivity, can be tuned by adjusting the in-plane charge density. The latter is typically achieved by chemical substitution (“doping”) or by alteration of the concentration of oxygen atoms in the spacer layers. Over the past two decades, considerable effort has gone into mapping out the electronic properties of layered cuprates as a function of in-plane charge density and temperature. The results are generally summarized in the form of a phase diagram.

In conventional superconductors, such as Pb and Nb, one can also alter the superconducting critical transition temperature, T_c , by chemical substitution; however, the phase diagrams of such materials are relatively simple. The normal (nonsuperconducting) state at $T > T_c$ is generally a good electronic conductor. Chemical substitution can alter the density of conduction electrons, resulting in shifts in T_c , but no other electronic phases of matter appear. As discussed below, the typical phase diagram of a cuprate compound is quite different. By tuning the charge density, one can change from a good electronic conductor to an electronically insulating phase. Magnetically ordered and disordered phases are

prominent, and unusual charge-ordered phases have been discovered. Some of these various types of electronic order appear to compete with the superconductivity. Of course, the proximity in the phase diagram of superconductivity to an alternative type of electronic order could result from closely related interactions. Thus, the study of “competing” order may yield important clues for understanding the mechanism of superconductivity, perhaps even providing approaches to manipulating the superconducting state.

Exotic Superconductors

In searching for general principles associated with high-temperature superconductivity, it is important to understand whether the concept of competing order is unique to the cuprates. It has been found that the competition of magnetic or charge-ordered phases with superconductivity is common among a variety of materials known as “exotic” superconductors. These include so-called “heavy-fermion” compounds, certain crystals made of conducting organic molecules, and some ruthenate and cobaltate compounds.

The intricate interplay of spin, charge, orbital, and lattice degrees of freedom is a hallmark of unconventional superconductors. Mapping electronic phase diagrams of these complex materials as a function of tuning parameters, such as composition, magnetic field, or pressure, is an important starting point for developing phenomenological concepts, unifying principles, and eventually mechanistic models of unconventional superconductivity. These phase diagrams have proven useful in revealing other nearby electronic phases that compete with or possibly promote superconductivity and that, in some cases, suggest the relevance of fluctuations associated with a quantum-critical transition of the nearby phase. They also reveal commonalities and differences among classes of unconventional superconductors. One striking commonality is the proximity of magnetism to superconductivity in classes of unconventional superconductors. The simple observation that phase diagrams are so sensitive to parametric tuning implies a complex balance among strongly coupled interactions, which is a distinctive characteristic of materials that support unconventional superconductivity.

Figure 19 presents an example in which pressure tuning of the antiferromagnet CeRhIn_5 induces a phase of coexisting magnetism and superconductivity that evolves at higher pressures into a purely unconventional superconducting (SC) state. Simultaneously tuning the superconducting phase with a magnetic field reveals a magnetic phase that was hidden by superconductivity in the absence of a field and establishes the existence of a magnetic quantum-critical point at pressure P_2 . Although the nature of field-induced magnetism remains to be established, there are striking similarities between what is found in this f -electron material and both electron- and hole-doped cuprates, suggesting a common origin from electronic correlations.

A second example is shown in Figure 20. URhGe orders ferromagnetically below 9.5 K; however, superconductivity appears when the temperature is reduced below 0.3 K (indicated by dark color in Figure 20 at zero magnetic field). Applying a magnetic field destroys the superconductivity, but there is a reentrance of unconventional superconductivity at high magnetic fields (>8 T). This particularly exciting and unexpected discovery suggests that a field-induced spin reorientation stimulates the reappearance of superconductivity in proximity to a magnetic quantum-critical point.

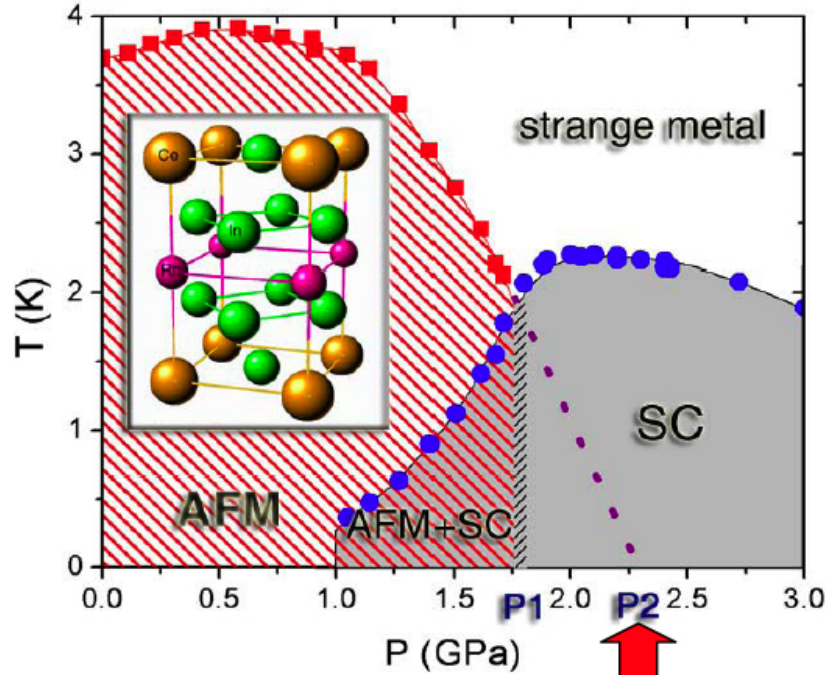

Figure 19 Pressure-temperature phase diagram of CeRhIn₅. Rather modest applied pressures tune the balance between competing antiferromagnetic (AFM) and superconducting (SC) phases.

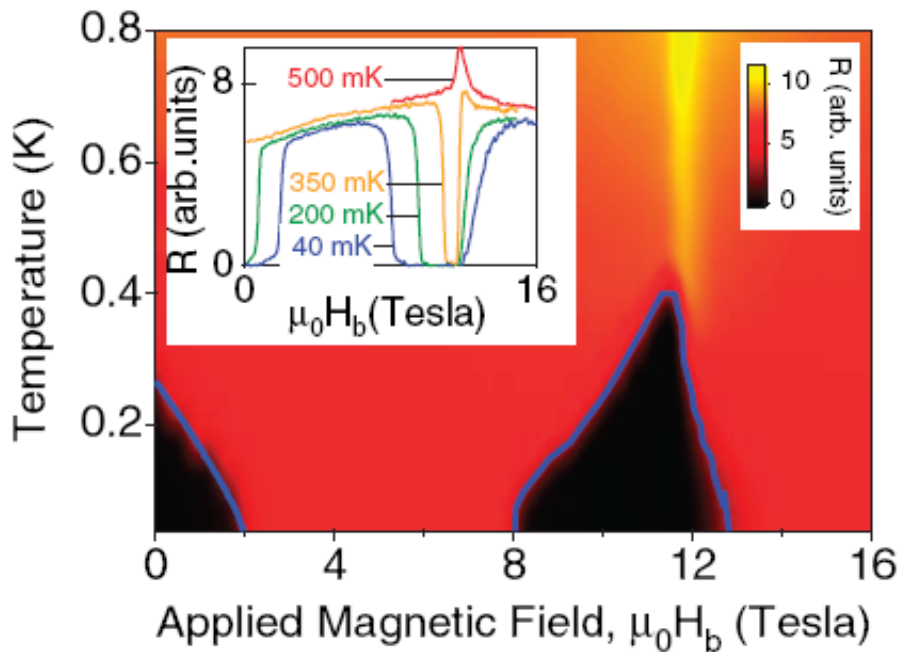

Figure 20 Magnetic field-temperature phase diagram of URhGe. Magnetic order and superconductivity are tuned as a function of magnetic field.

High-temperature Superconductors

The typical phase diagram (temperature vs. charge density) of a copper oxide superconductor is shown in Figure 21. The superconducting phase is indicated in blue; it is labeled “d-SC” to denote that the superconducting wave function has $d_{x^2-y^2}$ symmetry, as determined by a number of phase-sensitive experiments. As with some of the exotic superconductors discussed above, there is an antiferromagnetic insulator phase (AFI, green) present; however, this electronically insulating magnetic phase disappears before the superconducting phase is reached. In between is a magnetic “spin-glass” (SG) phase that can coexist with the superconductivity.

The most intriguing phase is that labeled “PG” for “pseudogap.” It is roughly characterized by a depression of the density of electronic states near the Fermi level. Various experimental signatures of the pseudogap state show up as the temperature is decreased below the dashed line labeled T^* . Within the pseudogap phase, there is a shaded region labeled “fl-SC” where there is experimental evidence for fluctuating superconductivity. Determining the true nature of the pseudogap phase is generally believed to be a key for understanding the mechanism of superconductivity in the cuprates. While many ideas have been proposed to explain it, there is no consensus at present. But, by analogy with heavy-fermion phase diagrams, the relationship of the pseudogap phase to the superconducting phase suggests that some sort of competing order could be involved. These ideas provide the key focus for new research directions in superconductivity.

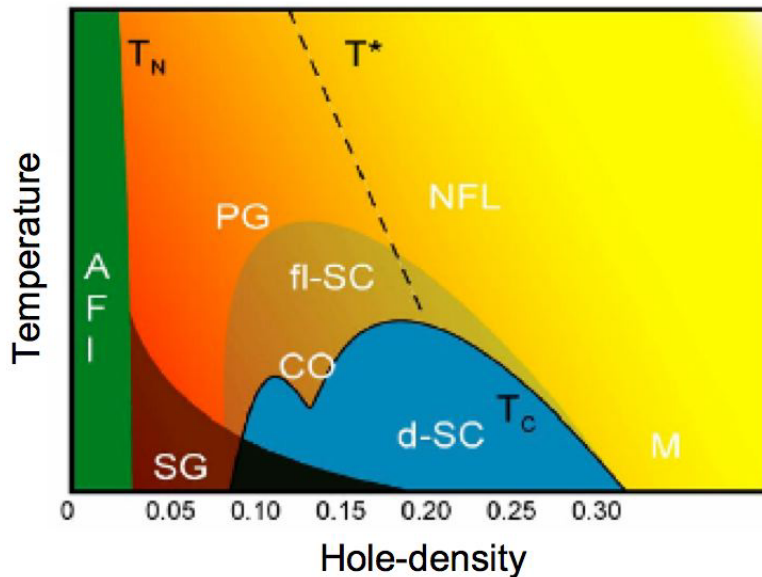

Figure 21 A schematic temperature/hole-density phase diagram of the high- T_c superconductors. Note: AFI = antiferromagnetic insulator; CO = charge-ordered state; d-SC = $d_{x^2-y^2}$ symmetry; fl-SC = fluctuating superconductivity; M = metal; NFL = non-Fermi liquid; PG = pseudogap; SG = spin-glass; T_N = Neel temperature.

NEUTRON SCATTERING

Neutron scattering is one of the primary tools for characterizing magnetic correlations in copper oxide superconductors. Neutron diffraction was initially used to determine the antiferromagnetic order of the parent compounds, which are electronic insulators. Inelastic neutron scattering continues to provide detailed information on the magnetic excitations across the phase diagram. Besides magnetism, neutrons provide a valuable tool for determining the atomic structure of newly discovered materials and for mapping atomic vibrations, which play an essential role in conventional superconductors.



The Spallation Neutron Source at Oak Ridge National Laboratory

Neutron beams are provided by research nuclear reactors and by special accelerator facilities where a high-energy proton beam slams into a heavy-metal target to knock neutrons out of the target nuclei (spallation process). The U.S. Department of Energy (DOE) operates one research reactor, the High Flux Isotope Reactor, at Oak Ridge National Laboratory (ORNL), and a second is operated by the U.S. Department of Commerce, National Institute of Standards and Technology (NIST) Center for Neutron Research, in Gaithersburg, Maryland. In addition to spallation sources at Argonne National Laboratory (the Intense Pulsed Neutron Source) and Los Alamos National Laboratory (the Lujan Center for Neutron Scattering), DOE has just completed construction of the Spallation Neutron Source (SNS) at ORNL. This figure, courtesy of ORNL, shows an aerial view of the SNS in late 2005. Its initial suite of five instruments is expected to expand to an eventual total of 24, many of which will be ideally suited to studies of superconductors. Following commissioning in 2007, the SNS should have the brightest beams for neutron scattering in the world.

One challenge in using neutrons is that the scattering cross section is weak compared to that of x-rays or electrons; furthermore, the flux in a neutron beam is substantially weaker than that of x-rays in a synchrotron beam. As a result, some neutron scattering experiments require very large single-crystal samples that must be grown by specialists. The bright beams and state-of-the-art instruments of the SNS will considerably improve the efficiency of neutron scattering instruments but will not eliminate the need for large, high-quality single crystals.

Key Scientific Questions

The panel reviewed key questions and research themes within the context of the thermodynamic phase diagram, with special emphasis on the magnetism of exotic superconductors. The issues include these:

The Nature of the “Pseudogap” Phase. There is a broad consensus that the pseudogap phase is one of the central mysteries of the cuprate superconductors. Initial experimental observations have motivated numerous creative theoretical ideas. There are suggestions that the pseudogap might be associated with a type of order that competes with superconductivity, or with a fluctuating type of electronic correlation that is not quite ordered, or that it might even be associated with fluctuating superconductivity. Phenomenologically, determining the nature of the pseudogap is important for understanding what limits the maximum superconducting transition temperature. It may also provide useful clues in devising a search for new superconducting materials.

Significant experimental progress has been made in recent years, but further research is required in order to narrow the possible interpretations and eventually reach a proper understanding. Thoughtfully designed experiments with a wide range of complementary techniques are needed. These include measurements of electronic states with techniques such as ARPES, scanning tunneling microscopy/spectroscopy (STM/STS), and optical spectroscopies; and measurements of magnetic correlations with neutron scattering, NMR spectroscopy, and μ SR.

The Electronic State in the Core of a Superconducting Vortex. As discussed elsewhere, an applied magnetic field with a strength above a material-dependent threshold value can penetrate a cuprate superconductor in quantized units of magnetic flux. The magnetic field is a maximum at the center of the fluxoid, and it decays as one moves radially from the core region, as a result of screening by a superconducting vortex current. In a conventional material, one would expect the electronic states to correspond to the normal nonsuperconducting phase, which would be a good electronic conductor. In cuprates, the states in the core may be associated with the pseudogap phase. Studies of electronic resistivity in magnetic fields high enough to suppress superconductivity have revealed an unusual sort of metal-insulator transition as a function of electronic doping.

Scanning tunneling spectroscopy studies have imaged (Figure 22) an unprecedented “checkerboard” modulation of the electronic density of states over a region that extends significantly beyond the vortex core. Neutron scattering measurements suggest stripes of magnetic order are induced by the magnetic flux, while NMR and μ SR have implicated local antiferromagnetism. Further research is necessary to understand how these various observations fit together, and to what extent they are universal for cuprate superconductors. Understanding the nature of an individual vortex core could be crucial for optimizing schemes for pinning vortex arrays.

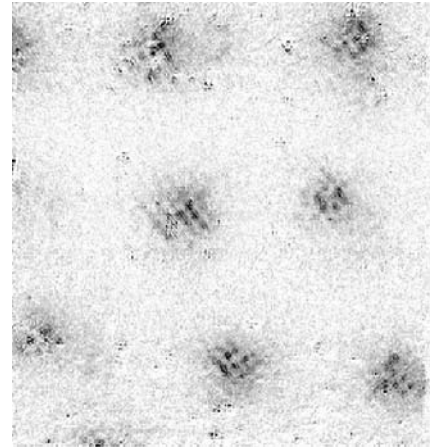

Figure 22 SI-STM image of the checkerboard density-of-states modulation at each vortex core in $\text{Bi}_2\text{Sr}_2\text{CaCu}_2\text{O}_x$. This image reveals inhomogeneity in the electronic density of states over extended length scales.

Planar Tunneling and Andreev Reflection Spectroscopies.

Although SI-STM offers unprecedented spatial resolution of the quasi-particle energy spectrum above and below T_c , there are limitations in the materials for which this technique is useful. The materials must be either cleavable in-situ or be capable of withstanding rigorous surface cleaning; many unconventional superconductors are not cleavable, and the cleaning process will destroy the integrity of the material, making SI-STM materials limited. Planar tunneling is the measurement technique that proved the Bardeen, Cooper, and Schrieffer (BCS) phonon mechanism of conventional superconductors. Andreev reflection, a fascinating process in which an electron impinges on a superconducting interface and is retro-reflected as a hole, is another powerful spectroscopic probe. These techniques not only provide quasi-particle energy and momentum resolution above and below T_c , but they recently have been shown to be phase-sensitive, so they can determine order parameter symmetry.

Whether the Upper Critical Field Corresponds to Pair Breaking. The usual assumption is that a strong magnetic field destroys superconductivity by breaking up the electronic Cooper pairs. In cuprate superconductors, especially given the novel character of magnetic vortex cores, this might not be true. The answer may be tied to the nature of the pseudogap phase. One possibility is that a high magnetic field might destroy superconducting phase coherence without destroying the electron pairing. Transport and spectroscopic studies in high magnetic fields will be necessary to resolve this issue. The answer is relevant to understanding the fundamental limits on magnetic critical fields in high-temperature superconductors.

RESEARCH IN EXTREME MAGNETIC FIELDS

One of the challenges in studying copper oxide superconductors is understanding the “normal” state from which superconductivity develops. One needs to know how the transport properties (such as electrical resistivity) of the normal state behave as the temperature heads to absolute zero; however, such behavior is obscured when the onset temperature of superconductivity is high. Very high magnetic fields provide an indispensable tool to overcome these difficulties by quenching superconductivity and revealing the properties of the underlying normal state. Within the United States, such research is performed at the National High Magnetic Field Laboratory, with facilities in Tallahassee, Florida, and at Los Alamos National Laboratory. Existing nondestructive pulsed magnets are capable of providing magnetic fields up to 60 T. The use of such magnets has uncovered a number of groundbreaking phenomena, such as a metal-to-insulator transition in the normal state underneath the superconducting state in certain copper oxide families, as well as signatures of a quantum phase transition.

A variety of other experiments have also made use of high magnetic fields. For example, it has been shown that fundamental information about the nature of the low-energy electronic states in a cuprate single crystal can be obtained from magnetoresistance oscillations as a function of the orientation of the magnetic field. Nuclear magnetic resonance spectroscopy in the high-field magnetic vortex state has revealed an additional feature in the electronic density of states inside the vortex core, as well as behavior suggestive of antiferromagnetism localized within the core. Measurements of a transverse electric field in response to an applied temperature gradient in the presence of a strong magnetic field (Nernst effect) have provided evidence for superconducting fluctuations at temperatures well above the critical temperature.

For the experiments described above, it has been necessary to choose materials with an upper magnetic critical field (H_{c2}) that is less than 60 T; it so happens that some of the superconductors with the highest transition temperatures have upper critical fields of several hundred teslas. To characterize these materials, advances in magnet technology are required. The accompanying figure shows a cutaway drawing of the 100-T pulsed magnet at Los Alamos. Direct thermodynamic measurements in the normal state of cuprate superconductors in extremely high magnetic fields will provide important clues for identifying the interaction responsible for high-temperature superconductivity.

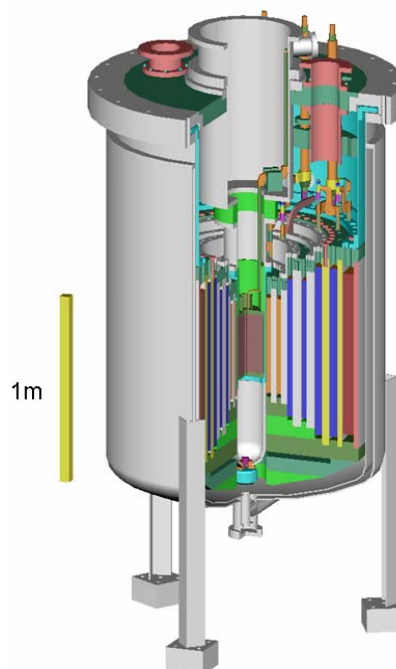

Schematic diagram of the 100-T magnet at Los Alamos National Laboratory

The Role of Quantum Phase Transitions. It is well known that thermal fluctuations can lead to the destruction of an ordered state. There is also growing appreciation that, at low temperatures, quantum fluctuations can lead to disordering. There have been many suggestions regarding the possible role of quantum fluctuations in the pseudogap phase. More generally, there are theoretical models in which variation of a particular parameter (magnetic field, pressure, etc.) causes a zero-temperature transition from an ordered to a disordered state. It has been proposed that the loss of magnetic order in the phase diagrams of various exotic superconductors, such as the heavy fermion systems described above, is due to a quantum phase transition. The occurrence of a superconducting phase with its maximum T_c close to the putative quantum critical point has raised interest about the connections between quantum fluctuations and unconventional superconductivity. There is a need for further experimental studies to determine whether observed phase transitions are truly driven by quantum fluctuations and for the development of theoretical models of quantum phase transitions that are directly relevant to real electronic materials.

LOCAL PROBES OF MAGNETISM

While neutron scattering is an excellent technique for characterizing the bulk-averaged magnetic correlations in a given sample, it is also essential to have probes sensitive to local properties. This is crucial if one is to investigate intrinsic inhomogeneities, especially induced inhomogeneities, as in the vortex-lattice state.

One important technique is NMR spectroscopy. An atomic nucleus that happens to have a magnetic moment will be sensitive to the local magnetic field, whether it is due to atomic magnetic order or to an applied magnetic field. In cuprates, there are isotopes of La, Cu, and O that are suitable for study. One can probe the nuclei by applying a large direct-current (dc) magnetic field and a transverse radio-frequency field. By scanning one of these fields, it is possible to measure transitions of the nucleus between different quantum states. If all nuclei in a sample experience the same local magnetic field, the spectrum will show a sharp transition. If there is a distribution of local fields, this will be reflected in the distribution of transitions. NMR continues to be a valuable tool in the investigation of magnetic properties of superconductors.

Another important technique is μ SR spectroscopy. Muons are effectively heavy electrons that can be produced at proton accelerators. Positive muon beams are generally selected for condensed-matter studies. A high-energy muon injected into a solid quickly equilibrates and localizes at a highly electronegative site. If there is a local magnetic field at that site, the polarization of the muon will precess about the field direction at a frequency proportional to the strength of the field. When the muon eventually decays into a positron (lifetime = 2.2 μ s), the positron tends to be emitted along the direction of the polarization. By detecting the emitted positrons, one can determine the precession of the muons. The observed distribution of precession frequencies reflects the distribution of local magnetic fields.

An advantage of both techniques is that they retain considerable sensitivity even with polycrystalline samples. This is especially important for the characterization of new materials, where single crystals are unlikely to be available.

New Emergent Forms of Quantum Matter. The study of cuprate superconductors has led to the discovery of new forms of electronic matter. One example is charge and spin stripe order, an illustration of which is shown in Figure 23. Another example is the checkerboard state mentioned above. Whether such states compete or cooperate with superconductivity remains controversial, as does whether they might be relevant to the pseudogap phase. A variety of experimental studies are required to better characterize these unusual states. Improved theoretical models are also needed.

Competing Phases as a Basis for the Search for New Superconductors. Over the past decade, a new approach to exploring the physics of complex systems has emerged. Faced with phase diagrams of bewildering complexity, people have investigated taking control of the situation by applying external control parameters to tune from one phase to another. This is a feasible line of inquiry because if a system has many interacting phases, then those phases are by definition close to being degenerate, so the free energy balance can be altered with laboratory-accessible pressures, magnetic fields, strains, and even electric fields. Driven by the success of such studies, huge advances have been made in technologies, such as those involving high pressure. However, there is much more to do.

One of the most exciting developments has been the realization that one can do much more than simply tune between existing phases. If a system with a continuous phase transition is tuned such that the characteristic temperature of that transition approaches zero, an exquisite free energy balance is created that is subject to divergent quantum fluctuations. A situation like this is a perfect breeding ground for new ordered states. When done in the right way, this type of physics can drive discovery.

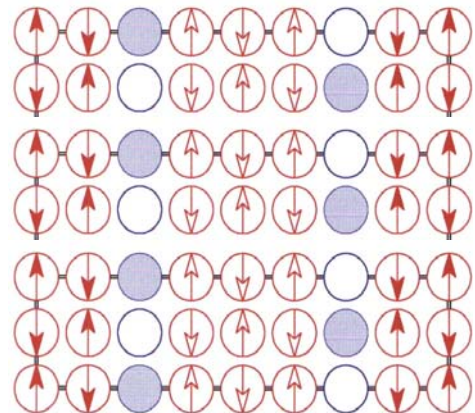

Figure 23 A schematic representation of a CuO_2 "stripe" indicating modulation in spin and charge

Disorder and Electronic Inhomogeneity. Exotic superconductors can be very sensitive to atomic-scale chemical or structural disorder. Reducing disorder might improve superconducting performance; however, disorder is sometimes an inevitable consequence of chemical substitution to control the charge density. There are also questions as to whether various forms of electronic inhomogeneity may be intrinsic to certain materials, or whether they are consequences of disorder. Measurements with local probes can be especially helpful in unraveling issues regarding disorder and inhomogeneity.

Emerging Experimental Techniques and Opportunities

The panel focused on reviewing the emerging suite of revolutionary experimental techniques and considering their potential applications. The discussions were motivated by a realization that a complete and detailed understanding of the electronic/magnetic properties of the CuO_2 plane — which is required to identify the electron pairing force — might now become possible; the special ingredients that give rise to high- T_c superconductivity could then be identified directly. Key new techniques reviewed by this subpanel include:

- *Angle-Resolved Photoemission Spectroscopy (ARPES).* Wavelike quantum states of the electrons are defined in momentum space (k -space). ARPES allows direct determination of the complete momentum-space electronic structure, $A(k, E)$, with remarkable energy and momentum resolution.
- *Spectroscopic Imaging-Scanning Tunneling Microscopy (SI-STM).* This is the complementary technique to ARPES that allows mapping of the energy-resolved quantum states in real space (r -space) with atomic resolution and yet over large sample areas.
- *Microwave/terahertz/infrared/optical spectroscopies.* These probe the electronic excitations and charge dynamics in both the frequency and time domains. This information is the key to understanding the dynamical interactions of the electrons.
- *Resonant elastic and inelastic x-ray spectroscopy.* Resonant elastic and inelastic x-ray scattering can now reveal spin and charge density waves and superlattices with tiny modulation amplitudes. This information is critically important for understanding spatially periodic electronic states of matter.
- *Neutron Scattering (NS).* High-intensity NS — for example, from the Spallation Neutron Source — will allow precision measurements of both magnetic ground states and the complete spectrum of magnetic excitations in high-temperature and exotic superconductors.
- *NMR/NQR/ μ SR.* NMR measures spin dynamics, NQR measures the charge heterogeneity and dynamics, and μ SR measures nanoscale variation in local magnetic field strength. These are essentially local spin/charge probes, but without imaging capabilities.

In copper oxide studies, a number of spectacular successes have already been achieved during the development of these new techniques. They include (1) measurement of the basic doping-dependent electronic structure of copper oxides, (2) detection of the d-wave superconducting gap, (3) discovery of doping dependence of superfluid density, (4) observation of a “pseudogap” that is anisotropic in momentum space, (5) measurement of the frequency- and momentum-dependent electron self-energies, (6) the emergence of the nodal quasi-particles in the immediate proximity of the Mott insulator phase,

(7) detection of fluctuating superconductivity above T_c , (8) discovery of unidirectional spin/charge “stripes” in LaBa(Sr)CuO, (9) observation of nanoscale electronic heterogeneity stemming from the dopant atom disorder, (10) observation of checkerboard electronic states in vortex cores and at low doping, (11) discovery of the kinetic energy change upon entering the superconducting state, and (12) discovery of mass renormalization associated with strong electron-boson coupling. The rapid pace of discovery points to a scientifically even more fruitful future, once comprehensive and coordinated studies using all of these techniques can be achieved.

Besides the copper oxides, these techniques have also been applied to the study of a whole range of problems in condensed matter, including electron-phonon coupling, charge density wave transitions, charge glass in manganites, the formation of quantum well structure in thin films and multilayers, and the electronic structure and Fermi surface of solids made of nanoclusters such as C_{60} . Furthermore, studies have identified the spin-charge separated components in a one-dimensional system, such as SrCuO₂.

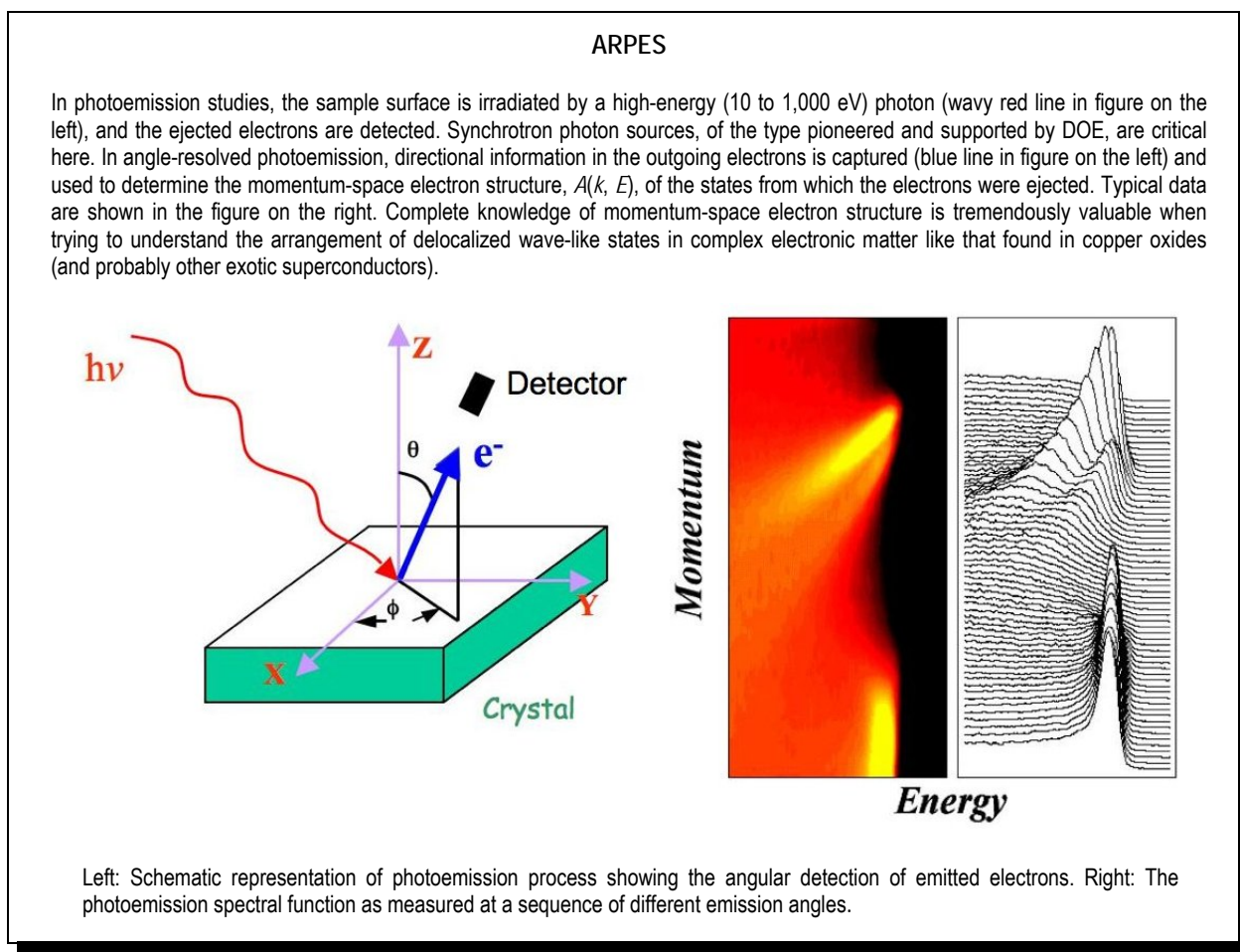

Comprehensive Mapping of Electronic/Magnetic Susceptibilities

The panel considered how this suite of techniques could allow researchers, for the first time, to gain a complete empirical understanding of the elementary excitations and collective modes — including those that are likely to play a role in mediating the pairing — in the copper oxides. The emerging proposal is for a coordinated effort using NS, NMR/NQR/ μ SR, ARPES, SI-STM, and resonant x-ray scattering to

determine the dependence of the electronic susceptibilities in real/momentum space on crystal type, doping, temperature, and energy. Similarly, a combination of spin-polarized ARPES, spin-polarized SI-STM, and NS could be applied to determine the dependence of the magnetic structure and susceptibilities in real/momentum space on crystal type, doping, temperature, and energy. Essentially, a comprehensive mapping to the electronic properties of the materials sufficient to reveal precisely how they function will soon become possible. But this would be a huge undertaking, rivaling astrophysical “sky surveys” or biological “genome mapping” in data volume and complexity. It also seems that it could be achieved only with coordination, cooperation, and sustained support. Furthermore, a coordinated effort among researchers at large-scale national facilities and in intermediate- and small-scale university laboratories will be required. Finally, synergistic relationships among experimental research, innovative theoretical ideas, large data volume management, and computational studies will also be required.

SI-STM

Standard STM is used to image the locations of atoms on a surface (see figure at right). SI-STM, however, allows the energy-resolved density of electronic states — essentially the quantum wave functions of the electrons — to be imaged with atomic resolution. A typical density-of-electronic-states spectrum at a single atom is seen in the inset on the figure on the right. The SI-STM technique will become a key tool for development of advanced magnetic/electronic materials: The impact on electron wave functions of impurity/dopant atoms, the crystal lattice, electron-electron interactions, and external electric/magnetic fields can all be determined directly at the atomic scale. It allows us to determine the real-space electron structure, $N(\vec{r}, E)$, completely. Knowledge of $N(\vec{r}, E)$ is tremendously valuable when trying to understand the arrangement of localized states in complex electronic matter like that found in copper oxides. The figure below shows, as an example, images of the superconducting energy gap disorder, Δ , and of the locations of the oxygen dopant atoms, O , creating this disorder. These represent practical examples of the utility of SI-STM studies.

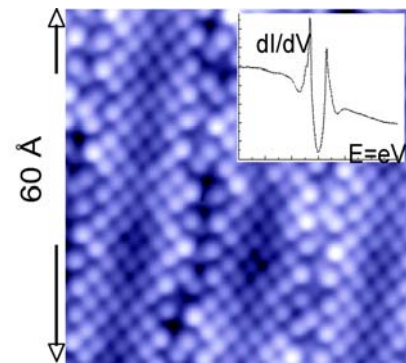

Topographic image of Bi atoms on the surface of $\text{Bi}_2\text{Sr}_2\text{CaCu}_2\text{O}_x$. The inset shows the differential conductance (proportional to local density of states) at one atomic location.

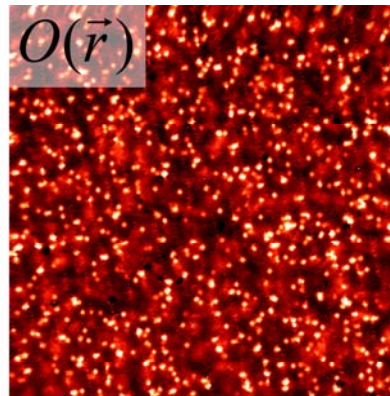
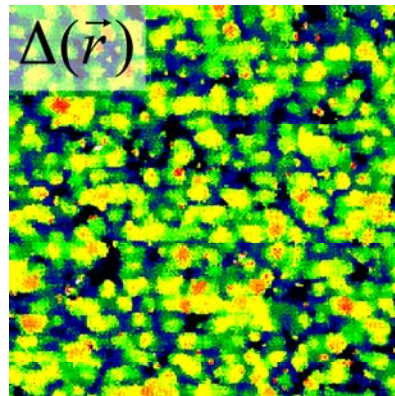

← 500 Å →

← 500 Å →

Left: The nanoscale superconducting energy gap disorder in $\text{Bi}_2\text{Sr}_2\text{CaCu}_2\text{O}_x$. Right: A simultaneous image of the dopant atom locations from SI-STM.

Imaging Atomic-scale Electronic/Magnetic Structure

A primary barrier to widespread application of transition metal oxides (TMOs), including the high-temperature superconductors, is the absence of a comprehensive and fundamental theory on how the atomic-scale interactions among spin, charge, and the lattice lead to the extraordinary observed properties. Rational design of new TMO materials and rational engineering of devices from TMOs are therefore presently impossible. A critical issue in TMO electronic structure is the small distance scales involved. Spin-charge-lattice interactions are so intense in the TMOs that most relevant electronic phenomena occur at relatively high energies and therefore at very short length scales (\sim atomic scale). While a wealth of physical data on TMOs are available from conventional experimental techniques, we know little about the atomic-scale structure of electronic states, and even less about their interactions with the charge/magnetic/lattice degrees of freedom. Of particular interest in the context of high-temperature superconductivity are effects with the loss of electronic translational invariance: the formation of electronic crystals, electronic liquid crystals, or pair crystals/glasses. SI-STM, inelastic x-ray scattering, nanometer-resolution ARPES, and transient grating optical spectroscopy will play a key role in characterizing these effects. A coordinated combination of these tools will be required to determine the electronic/magnetic/superconducting phenomena in disordered, glassy, or nanoperiodic environments at the atomic scale.

Understanding the Dynamical Processes

Other elements that we need to understand completely are the dynamical processes occurring in interactions between electrons and between them and their environment. Microwave spectroscopy is widely used, since measurement of kinetic inductance in the microwave regime is a direct probe of the superfluid density. Terahertz-frequency measurements represent another area where techniques have developed rapidly; they have been instrumental in revealing the Drude response of quasi-particles below T_c . The YBCO system appears to be unique in the cuprate family in that its Drude peak is extremely narrow, corresponding to quasi-particle scattering rates of 10–100 GHz at low temperatures. In all other cuprate systems, the quasi-particle Drude peak extends into the terahertz regime. The results point to the near ubiquity of the kind of nanophase disorder that has been clearly seen by SI-STM. Infrared spectroscopy also plays a key role, for example, in identifying the pseudogap and determining the spectral weight and transport lifetime of quasi-particles. Finally, there has been a strong focus on the temperature dependence of the spectral weight, as quantified by the integral of the real part of the conductivity over frequency. Within certain assumptions, there is a quantitative connection between the spectral weight and the kinetic energy of the electrons in a band, with growing evidence that the sign of the spectral weight changes that occur upon entering the superconducting state is consistent with kinetic energy lowering on the underdoped side of the phase diagram and doing the opposite on the overdoped side. (For reference, a BCS-like transition driven by coupling to phonons is expected to occur with an increase in kinetic energy, consistent with overdoped but not underdoped compounds.) Time-resolved probes will also play a critical role; in such experiments, Cooper pairs are broken by excitation with ultrashort optical pulses, creating a nonequilibrium population of quasi-particles. The lifetime of the quasi-particles is probed by measuring the transient change in reflectivity. In the last few years, the dynamics of nonequilibrium quasi-particles have been considerably clarified; in underdoped cuprates, the recombination lifetime diverges at low temperature. The long lifetime holds out the promise of probing the distribution of nonequilibrium quasi-particles in momentum space via time-resolved ARPES. Through this measurement, it may be possible to see directly the scattering of quasi-particles in the Brillouin zone and thus gain information about the momentum of the excitations that cause quasi-particles to scatter and perhaps bind into Cooper pairs. Finally, although microwave, terahertz, infrared, and optical techniques are the principal tools to be used in this area, high-frequency SI-STM and ARPES could play a supportive role. A combination of these

tools should be developed and applied to characterize the dynamical processes and interactions between the electrons themselves and those with the superfluid electron pairs and the crystal.

New Theoretical and Analytical Frameworks

Equivalently important for progress in these formidable tasks will be the development of theoretical approaches and frameworks well-suited to analyze the high volumes of experimental data to be derived from complementary experimental probes.

CROSS-CUTTING RESEARCH NEEDS

Significant progress in understanding high- T_c superconductivity will be possible only through a consistent description of experimental data obtained from using all of these complementary new techniques. Thus, a broad access to data — a practice common in astrophysics and in high-energy physics, but not in condensed matter science — will be required. Several panelists discussed ideas for national databases with some review process and agreements for wide access.

In the future, these techniques will be required at even higher energy, momentum, and temporal resolution, as well with dramatically improved data-acquisition efficiency. Other areas where progress is required for future development include high spatial resolution of both infrared/optical and ARPES experiments, to increase the bulk sensitivity of techniques that traditionally are sensitive only to surface properties. Another important direction is toward time-of-flight techniques for photoemission measurements. The higher spatial resolution of spectroscopic probes will complement STM data on cuprates and other oxides. It is quite possible that with sufficiently high spatial resolution in both ARPES and near-field infrared/microwave techniques, it will be possible to study the spatial variation of the electron mean free path by local measurements of the spectra. The development of increased bulk sensitivity of ARPES experiments can be achieved either by going to low photon energies, as was recently demonstrated in the use of lasers as the excitation source, or by going to high photon energies.

Essential to all of the experimental work discussed above is the synthesis of high-quality crystals and thin films. Improvements in sample quality over the past decade have resulted in tremendous improvements in our understanding of the intrinsic properties of various cuprate superconductors. One limitation is that a sample that is good for one technique may not be adequate for another. For example, ARPES and STM are surface-sensitive techniques that require samples with atomically flat surfaces. Materials that cleave easily are good for ARPES and STM studies. Unfortunately, a material that cleaves well can be difficult to grow as a large crystal, as is required for neutron scattering experiments. Conversely, materials for which large crystals can be grown may not cleave well. It is important to be able to apply a range of techniques to identical material. To achieve this end, improvements in synthesis capabilities and facilities that will allow their seamless integration with measurement capabilities will be required.

CONCLUSION

The central problem we face is to identify, and then exploit for energy security, the special electronic ingredients that can create a high-temperature superconducting state. Ideally, we will come to understand the principles involved so well that, through modern materials design/assembly, we will create superconductors operating at or above room temperature. But the complexity of this problem is such that its solution has eluded a generation of condensed matter physicists. It now appears that new research avenues are required, such as exploitation of the “competing orders” paradigm or new measurement techniques as described in this survey. And we will soon have available, thanks primarily to investment

from DOE, the most powerful suite of condensed matter experimental techniques that have ever existed. Thus, the research community is poised to launch a comprehensive and coordinated assault on the problem of understanding high-temperature superconductivity. With appropriate support, the long-term impacts of this program could include the identification of not only the mechanism of high-temperature superconductivity but also the mechanisms of other complex electronic matter states with great technological potential, such as those exhibiting colossal magnetoresistance and giant thermopower.

REFERENCES

- D.N. Basov and T. Timusk, “Electrodynamics of High- T_c Superconductors,” *Rev. Mod. Phys.* **77**, 721 (2005).
- D.A. Bonn, “Are High-temperature Superconductors Exotic?,” *Nature Physics* **2**, 159–168 (2006).
- A. Damascelli, Z. Hussain, and Z.-X. Shen, “Angle-resolved Photoemission Studies of the Cuprate Superconductors,” *Rev. Mod. Phys.* **75**, 473 (2003).
- M. Imada, A. Fujimori, and Y. Tokura, “Metal-Insulator Transitions,” *Rev. Mod. Phys.* **70**, 1039 (1998).
- S.A. Kivelson, I.P. Bindloss, E. Fradkin, V. Oganesyan, J.M. Tranquada, A. Kapitulnik, and C. Howald, “How to Detect Fluctuating Stripes in the High-temperature Superconductors,” *Rev. Mod. Phys.* **75**, 1201–1241 (2003).
- B.G. Levi, “New Experiments Highlight Universal Behavior in Copper Oxide Superconductors,” *Physics Today* **57**(9), 24–27 (2004).
- F. Lévy, I. Sheikin, B. Grenier, and A.D. Huxley, “Magnetic Field-induced Superconductivity in the Ferromagnet UrhGe,” *Science* **309**, 1343–1346 (2005).
- A.P. Mackenzie and Y. Maeno, “The Superconductivity of Sr_2RuO_4 and the Physics of Spin-triplet Pairing,” *Rev. Mod. Phys.* **75**, 657–712 (2003).
- T.E. Mason, “Pulsed Neutron Scattering for the 21st Century,” *Physics Today* **59**(5), 44 (2006).
- V.F. Mitrovic, E.E. Sigmund, M. Eschrig, H.N. Bachman, W.P. Halperin, A.P. Reyes, P. Kuhns, and W.G. Moulton, “Spatially Resolved Electronic Structure Inside and Outside the Vortex Cores of a High-temperature Superconductor,” *Nature* **413**, 501 (2001).
- S. Ono, Y. Ando, T. Murayama, F.F. Balakirev, J.B. Betts, and G.S. Boebinger, “Metal-to-insulator Crossover in the Low-temperature Normal State of $\text{Bi}_2\text{Sr}_{2-x}\text{La}_x\text{CuO}_{6+\delta}$,” *Phys. Rev. Lett.* **85**, 638 (2000).
- J. Orenstein and A.J. Millis, “Advances in the Physics of High-temperature Superconductivity,” *Science* **288**, 468–474 (2000).
- T. Shibauchi, L. Krusin-Elbaum, M. Li, M.P. Maley, and P.H. Kes, “Closing the Pseudogap by Zeeman Splitting in $\text{Bi}_2\text{Sr}_2\text{CaCu}_2\text{O}_{8+y}$ at High Magnetic Fields,” *Phys. Rev. Lett.* **86**, 5763 (2001).
- T. Timusk and B. Statt, “The Pseudogap in High-temperature Superconductors: An Experimental Survey,” *Rep. Prog. Phys.* **62**, 61–122 (1999).
- J.M. Tranquada, *Neutron Scattering Studies of Antiferromagnetic Correlations in Cuprates*; available at <http://aps.arxiv.org/abs/cond-mat/0512115>.

Y.J. Uemura, “Superfluid Density of High- T_c Cuprate Systems: Implication on Condensation Mechanisms, Heterogeneity, and Phase Diagram,” *Solid State Communications* **126**, 23–38 (2003).

Y. Wang, L. Li, and N.P. Ong, “Nernst Effect in High- T_c Superconductors,” *Phys. Rev. B* **73**, 024510 (2006).

G.-Q. Zheng, P.L. Kuhns, A.P. Reyes, B. Liang, and C.T. Lin, “Critical Point and the Nature of the Pseudogap of Single-layered Copper-Oxide $\text{Bi}_2\text{Sr}_x\text{La}_{2-x}\text{CuO}_{6+\delta}$ Superconductors,” *Phys. Rev. Lett.* **94**, 047006 (2005).

BASIC RESEARCH CHALLENGES IN SUPERCONDUCTING MATERIALS

CURRENT STATUS

The Search for Novel Superconductors

Superconductivity research has been driven by the discovery of new materials with previously unknown properties and potential. These discoveries have had impacts well beyond the realm of condensed matter physics, with effects ranging from improvements in medical diagnostic tools, such as magnetic resonance imaging (MRI), to the development of theories about the interiors of neutron stars. In the nearly 100 years since superconductivity was discovered, the highest temperature at which it is known to exist has increased from close to absolute zero, 0 K (-273°C), to above 150 K. During that same time period, compounds that sustain superconductivity at higher and higher magnetic fields have also been discovered, leading to the now ubiquitous use of superconducting magnets in medical and research labs around the world. The lesson of the past century of research is that superconductivity can occur in unexpected places and at unexpectedly higher and higher temperatures. The search for new superconductors remains a daunting yet invigorating task. Fewer than 1% of the possible compounds for superconductivity have been examined so far. The challenge is to search for new superconductors in a wide, but physically delineated, phase space, thereby reducing the risk factor but maintaining the high payoff for this endeavor. The “high-risk, high-payoff” task of proceeding with this search holds the promise of discovering new superconductors that can be incorporated into new technologies, with profound impact on energy creation and distribution and energy system reliability.

Advanced Synthesis of Superconductors

Society has benefited tremendously from access to the refined, high-quality materials that enabled the computer revolution of the 20th century. The discovery two decades ago of superconductivity at remarkably high temperatures in the layered copper oxides has spurred many subsequent discoveries of novel exotic superconductors (see Figure 24). They include magnesium diboride (MgB_2), with its remarkably high critical transition temperature (T_c) (in which, effectively, two superconductors coexist in a single structure); borocarbide superconductors (which display a unique coexistence of magnetic and superconducting properties); fullerenes (which have nanosuperconducting characteristics); and the relatively “high-temperature,” heavy fermion compounds. All these different classes of superconductors are united by the fact that the electrons form pairs in order to superconduct. However, the fundamental physical mechanisms that provide the pairing “glue” for the electrons may differ among the various materials classes, and they are, in general, poorly understood. Fundamental understanding is impeded by the lack of sizable crystals of adequate and reproducible structural quality. Novel synthesis methods developed in recent years will play a pivotal role in removing these impediments.

High superconducting transition temperatures are observed in well-ordered, high-quality crystals. For a given material system, the crystal quality is often strongly dependent on the synthesis technique and conditions. Control and manipulation of crystalline order are required down to the atomic scale to understand the rich properties of existing superconducting phases. Such control will allow researchers to separate sample-specific properties from the intrinsic materials properties essential for superconductivity.

Examples of new crystal synthesis methods developed in recent years include novel techniques for solution and vapor transport, as well as the crucible-free growth of large single crystals by using the floating-zone method. The latter method, recently developed in Japan, has become a central tool for preparing sizable single crystals, because it is versatile and does not rely on crucibles or containment vessels, which are a common source of impurity contamination.

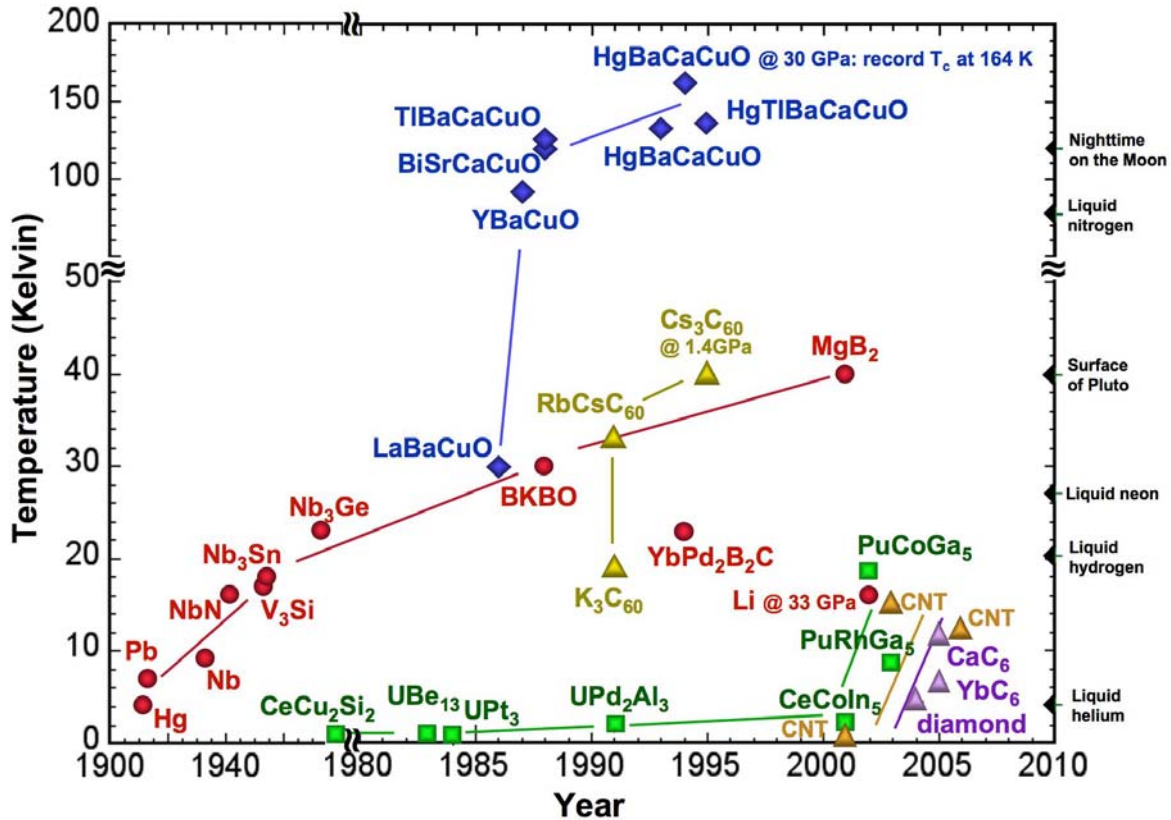

Figure 24 The observed superconducting transition temperature (T_c) of a variety of classes of superconductors is plotted as a function of time. Recent discoveries have increased the highest-observed T_c in a number of materials to unprecedented levels, such as in heavy fermion (PuCoGa_5), carbon nanotubes (CNTs), and graphite intercalated compounds (CaC_6).

At present, thin-film superconductors are grown by a number of techniques, including reactive molecular beam epitaxy (MBE), sputtering, chemical vapor deposition, and pulsed laser deposition. MBE in particular can produce epitaxial superconducting films with properties comparable to those of freestanding crystals. Nonequilibrium methods currently being developed around the world will enable the growth and atomic-layer engineering of multilayer films with novel functionalities.

This variety of synthesis techniques is essential, since no one tool fits all materials systems, and since many important superconductors have been prepared only in polycrystalline form, with less-than-desirable purity and structural quality. Proper understanding demands the growth of a much broader range of sizable, high-quality crystals, and it will require innovative new synthesis approaches.

Figure 25 tabulates many of the known copper-oxygen superconductors according to the number of copper-oxygen layers in their basic structural unit [ranging from (1) to (3)] and the most prevalent type of disorder present in the material [with disorder of type (a) being the most disordered and that of type (c) being the least detrimental to superconductivity]. Although many existing high- T_c superconductors have been grown successfully in single crystalline form, no sizable crystals of the highest- T_c materials yet exist.

The availability of such perfect crystals or films and their detailed experimental study by cutting-edge experimental probes would yield crucial information required for a unified theory of high- T_c .

Halogen Family	Bi Family	(a)	(b)	(c)
Pb Family	1L TI Family			
La Family	2L Family	(1)	(a-1)	(c-1)
YBCO Family	Hg Family			
			(a-2)	(b-2)
			(a-3)	(b-3)

	T_c		T_c		T_c
$\text{Ca}_{2-x}\text{Na}_x\text{CuO}_2\text{Cl}_2$	26			$\text{Sr}_2\text{CuO}_2\text{F}_{2+x}$	46
$\text{Pb}_2\text{Sr}_{2-x}\text{La}_x\text{Cu}_2\text{O}_2$	33			$\text{La}_2\text{CuO}_{4.5}$	45
$\text{La}_{2-x}\text{M}_x\text{CuO}_4$	39			$\text{Tl}_2\text{Ba}_2\text{CuO}_{6+5}$	93
$\text{Bi}_2\text{Sr}_{1-x}\text{Ln}_x\text{CuO}_{6+5}$	38			$\text{HgBa}_2\text{CuO}_{4+5}$	98
$\text{TlBa}_{1+x}\text{La}_{1-x}\text{CuO}_5$	45				
$\text{La}_{2-x}\text{Sr}_x\text{CaCu}_2\text{O}_6$	60	$\text{Pb}_2\text{Sr}_2\text{Y}_{1-x}\text{Ca}_x\text{Cu}_3\text{O}_{6+5}$	80	$\text{YBa}_2\text{Cu}_3\text{O}_{7-5}$	93
$(\text{La}_{1-x}\text{Ca}_x)(\text{Ba}_{1-75-x}\text{La}_{0.25+x})\text{Cu}_3\text{O}_7$	80	$\text{Y}_{1-x}\text{Ca}_x\text{Ba}_2\text{Cu}_3\text{O}_{7-5}$	90	$\text{TlBa}_2\text{CaCu}_2\text{O}_{7+5}$	110
$\text{Bi}_{2+x}\text{Sr}_{2-x}\text{CaCu}_2\text{O}_{8+5}$	90	$\text{Bi}_2\text{Sr}_2\text{Ca}_{1-x}\text{Y}_x\text{Cu}_3\text{O}_{9+5}$	96	$\text{Tl}_2\text{Ba}_2\text{CaCu}_3\text{O}_{9+5}$	110
				$\text{HgBa}_2\text{CaCu}_3\text{O}_{6+5}$	120
$\text{Bi}_{2+x}\text{Sr}_{2-x}\text{Ca}_2\text{Cu}_3\text{O}_{10+5}$	110	$\text{TlBa}_2\text{Ca}_{2-x}\text{Cu}_3\text{O}_{9+5}$	131	$\text{TlBa}_2\text{Ca}_2\text{Cu}_3\text{O}_{9+5}$	133
$\text{TlBa}_{2-x}\text{Ca}_2\text{Cu}_3\text{O}_{9+5}$	123			$\text{Tl}_2\text{Ba}_2\text{Ca}_2\text{Cu}_3\text{O}_{10+5}$	125
				$\text{HgBa}_2\text{Ca}_2\text{Cu}_3\text{O}_{10+5}$	135

Figure 25 Classification scheme of bulk high-temperature superconductors in terms of the different types of disorder [(a-b)] and the number of copper-oxygen planes in the basic crystal unit [(1-3)]. The original high- T_c material $\text{La}_{2-x}\text{M}_x\text{CuO}_4$ (with $M = \text{Ba}$) is in the top left panel (a-1), while the materials with the highest values of T_c belong to category (c-3). The effects of disorder decrease from left to right, and the materials with the highest values of T_c have three neighboring copper-oxygen sheets in the basic crystal unit.

superconductivity. Furthermore, these in-depth characterizations will be a decisive step toward understanding whether desirable materials, such as an ultra-high-temperature isotropic superconductor or a room-temperature superconductor, can be fabricated.

Nanoscale Superconducting Materials

The development of new nanostructured high- T_c superconductors, in which the structure and assembly of atoms are manipulated on the nanometer scale, may provide — in addition to enhanced superconducting properties — improved mechanical stability, resistance to corrosion, and enhanced normal-state properties, as well as the possibility of external control of superconducting properties. Many of these attributes have been demonstrated individually, but putting them all together into a single material, device, or system is a great challenge.

One challenge confronting the design and study of novel bulk superconductors is the difficulty in controlling the chemical synthesis parameters. A promising means to “design” well-controlled materials is in the development of novel nanostructured high- T_c superconductors. Nanoscale superconductors have one or more geometrical dimensions constrained to nanometer size to form clusters, wires, and films. This leads to behavior that is fundamentally different from that of bulk systems. Structures assembled with these building blocks have properties that are different from those of their constituent elements and are effectively new materials, which may exhibit enhanced properties. These building blocks can be used to control chemical composition at atomic length scales and to engineer superconducting compounds with crystal structures that cannot be formed by using conventional crystal growth techniques.

Organized nanostructures can be assembled by either top-down techniques, such as lithography, or bottom-up processes, such as self-assembly. There are already a number of examples of materials with enhanced superconducting properties that have emerged from this technological milieu. For instance, nanoengineered decoration of superconductors with arrays of ferromagnetic disks has been shown to enhance flux pinning and critical currents.

MAGNETIC NANODOTS FOR VORTEX PINNING

One of the most deleterious effects in superconductors that carry an electrical current is the motion of superconducting vortices when subjected to an external magnetic field. Because energy dissipation occurs when vortices move, the superconductor, in effect, ceases to exhibit zero electrical resistance. Ordinarily, most materials have many defects that anchor (“pin”) the superconducting vortices, thus restoring superconductivity. Unfortunately, in many cases, these pinning centers simultaneously have deleterious effects on other superconducting properties, such as the critical temperatures and fields. Thus, a major challenge in improving the current-carrying capabilities of superconductors is to effectively control and enhance pinning of the superconducting vortices without degrading other superconducting properties.

A possible avenue for this was shown in conventional superconductors by using nanoscale magnetic structures. The figure below shows a comparison of the resistance as a function of the magnetic field of niobium (Nb) (a superconducting element) and a composite Nb-magnetic nanostructure. As the magnetic field increases, the resistance of the Nb film increases in a monotonic fashion. However, if an assembly of magnetic nanodots is in contact with the very same Nb film, the resistance exhibits periodically enhanced superconducting properties. This is shown on the right side of the figure by the periodic decrease (sometimes by as much as a factor of 50) in the resistance.

Enhanced Properties with Magnetic Dots

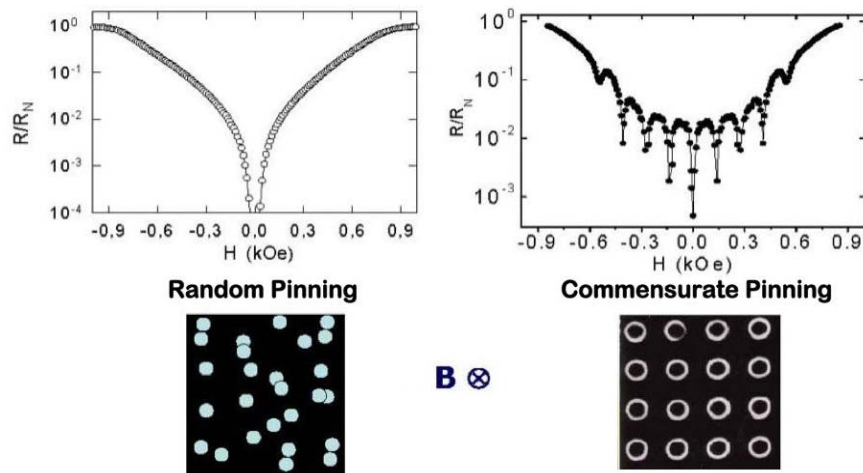

Extending these ideas to high-temperature superconductors (including disordered and fractal pinning arrays) provides a clear path offering a high likelihood of success. Eventual application of these ideas to commercially viable systems will also require massive production of composites incorporating nanopins and superconductors.

BASIC SCIENCE CHALLENGES, OPPORTUNITIES, AND RESEARCH NEEDS

Rational Design in the Search for New Superconductors

Over the past 20 years, a vast new chemical and physical frontier has opened in the search for new superconducting materials. We are now poised to explore this frontier and anticipate discovering new superconductors possessing greatly improved properties. For example, the discovery of a ductile superconductor with an operational temperature high enough to be cooled by liquid natural gas would have an impact comparable to the discovery of a superconductor with T_c above room temperature. As has already been emphasized, there is also a growing appreciation that superconductivity can emerge from a wide variety of mechanisms in a broad variety of materials.

Chemical compounds containing light, reactive, refractory (i.e., having a high melting-point), and/or volatile elements have not yet been well explored. This lack of exploration is due in part to the difficulty associated with incorporating these elements into compounds and handling them with existing growth techniques. In many cases, these are the very elements that are expected to contribute to higher critical temperatures or novel properties. The recently discovered compound MgB_2 , with its remarkably high transition temperature of 40 K, is precisely such a compound, being composed of magnesium, which is light, reactive, and volatile, and boron, which is light and refractory. We need to develop new growth techniques that would allow for the thorough exploration of such compounds, with the intent of discovering other examples of high-temperature superconductivity, as well as possible new forms of superconductivity.

Recently, novel techniques that allow researchers to control materials synthesis at an atomic level have been developed. Atomic-layer engineering using MBE along with quench, kinetic, or strain stabilization of metastable materials allows researchers to make artificial “metastable” phases, akin to synthetic diamond, which are very hard to make but very useful. It is also possible to create superconductors from compounds that are ordinarily not superconducting through the application of extreme pressure, electric field, magnetic field, or mechanical strain.

To identify new classes of superconducting materials with vastly improved properties, we will need to improve upon existing synthesis and characterization techniques and develop new ones specifically targeted for this task. Some areas that are ripe for development are synthesis methods for incorporating reactive, volatile, and/or refractory elements; generation of metastable phases in both thin films and bulk crystals; and combinatorial synthesis and complementary characterization tools for rapid, reliable, and versatile screening of new compounds. Finally, we need new techniques to detect the presence of minute superconductivity in complex chemical compounds.

With the tremendous increase in computer power and developments in theoretical modeling and algorithms of recent years, theory is now poised for a more substantial role in the search for new exotic and improved superconductors. For example, a recently proposed novel mechanism for superconductivity suggests searching for superconductors in parts of the periodic table ranging from carbon or gallium through more exotic metals such as rhenium or osmium all the way to lanthanides like praseodymium or even actinides like plutonium. These model-inspired searches provide a new rational design to the search for new materials, and they could reduce the high-risk/high-payoff quotient. Improvements in theoretical understanding and materials synthesis will continue to go hand-in-hand.

The search for new materials with novel or improved properties is a cross-cutting research endeavor that transcends the field of superconductivity. During the search for new superconductors, new materials will inevitably be discovered, which, although they may not be superconducting, will still affect broader energy security challenges. Such new materials may manifest improved magnetic, dielectric, or sensor properties — to name but a few. The new and improved synthesis and characterization techniques and

tools that will be developed in the search for new superconductors will also be helpful in the search for other desired materials.

Novel Synthesis Methods

The central scientific and technological challenge is to broaden the range of available materials with desirable qualities and properties for all classes of superconductors. The development of materials that can function in energy applications must be approached from two directions. On the one hand, the challenge is to obtain the pure superconducting state devoid of crystal defects to enable a rigorous scientific study of the fundamental physical properties that underlie the superconducting mechanism. This requires the understanding, control, and elimination of secondary phases, disorder, defects, and grain boundaries. On the other hand, materials for practical applications will always contain defects to promote vortex pinning, which can lead to enhanced current-carrying capacity. In order to understand how these defects affect materials properties, the challenge is to make samples with intentionally introduced secondary phases and defects. Controlled introduction of defects will allow us to address fundamental issues related to magnetic flux pinning that affect the upper limits of the magnetic field and current density and that are crucial to the feasibility of such applications as power cables and motors.

Artificially structured thin films are of great interest for facilitating the controlled study of “proximity effects” in superconductors, where two different materials, such as a superconductor and a normal metal or magnetic material, are placed in close contact. These films enable the study of interactions at precisely defined interfaces and open the door to entirely new phenomena that may arise because of the electronic interactions at these tailored interfaces. Improved synthesis precision will help in the study of superconducting heterostructures, together with advanced theoretical modeling of metastable materials. These will enable the exploration and perhaps the enhancement of the interactions that give rise to high-temperature superconductivity by engineering interactions at the interfaces. Indeed, entirely new properties can be programmed to emerge at interfaces, and the prospect of achieving higher T_c in engineered materials is a very strong motivation for this work.

The intrinsically short length scales of high-temperature superconductors require that the emergent phenomena be studied at the nanoscale. It is apparent that advanced synthesis of known superconductors with decisive control on all length scales down to the atomic scale can succeed only if it goes hand-in-hand with advanced materials characterization, which incorporates local and global structural and magnetic information from x-ray and neutron scattering probes. In-situ diagnostics during synthesis will prove to be invaluable.

Some key technical challenges for synthesis are better control of the temperature gradient and nucleation, novel solutions from which to grow crystals, new and better crucibles, and novel vapor transport methods. Of particular value would be the development of high-temperature and high-pressure crystal synthesis methods, such as contactless floating-zone growth under high pressures. High-pressure synthesis may hold the key to the growth of sizable crystals of the mercury-based superconductor, the material with the highest known value of T_c . In the case of MgB_2 , a great deal of information has been obtained from using high-quality polycrystalline powders and wires. A deeper understanding, however, requires large single crystals suitable for measuring physical properties. The first crystals of MgB_2 were made in Switzerland, Japan, and Korea. The United States still lacks high-pressure facilities in which to grow large single crystals, hampering the study of alloyed MgB_2 in particular.

EVOLVING COMPLEXITY OF SUPERCONDUCTING STRUCTURE

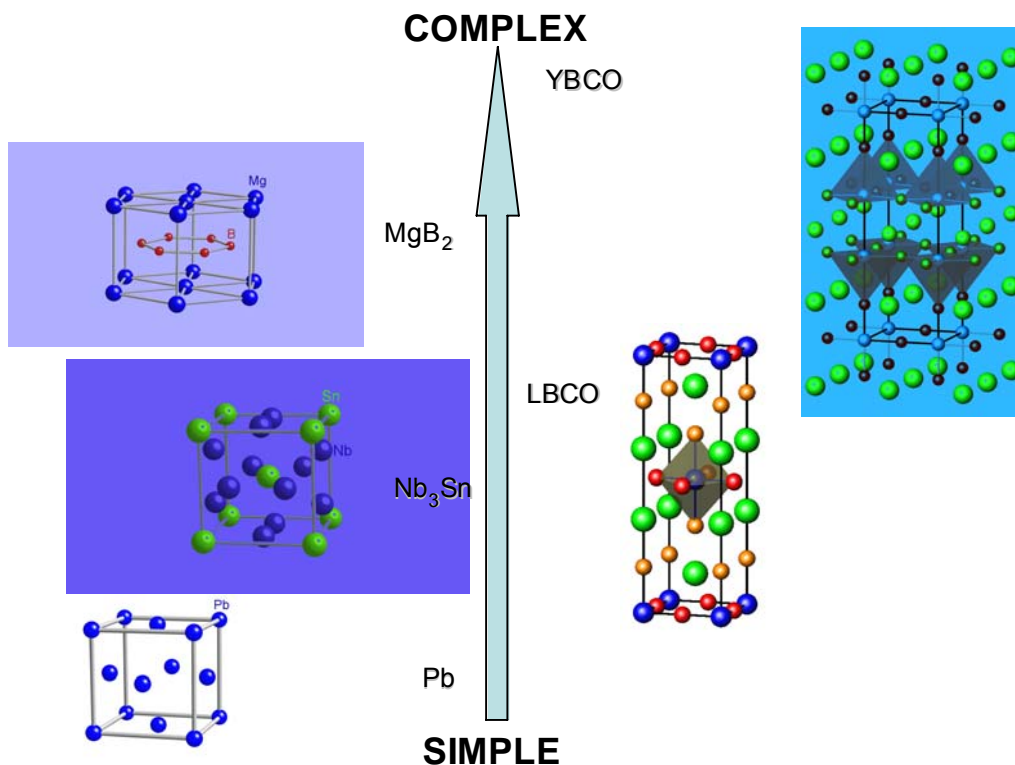

The lefthand side of this illustration shows “conventional” superconductors in which Cooper pairs are “glued” by lattice vibrations. Metal elements (for example, lead [Pb], with a T_c of 7.2 K) usually adopt close-packed three-dimensional structures, in which the atoms arrange themselves like balls in a box in order to fill the maximum amount of space. Binary-compound superconductors can also have a closely packed structure; an example is niobium-tin (Nb_3Sn), with a T_c of 17.9 K. Magnesium diboride (MgB_2), the conventional superconductor with the highest-known T_c (40 K), has a layered structure that consists of hexagonal (honeycomb) planes of boron (B) separated by planes of magnesium (Mg) atoms.

The righthand side of the illustration shows the crystal structure of “unconventional” high- T_c superconductors. The first material discovered in this class, lanthanum-barium-copper oxide (LBCO), with a T_c of 35 K, consists of copper oxide (CuO_2) planes that are sandwiched between lanthanum and barium oxide (La,BaO) charge-reservoir layers. Yttrium-barium-copper oxide (YBCO), the first liquid-nitrogen superconductor, with a T_c of 92 K, has a more complex structure, with two CuO_2 planes, one yttrium (Y) layer, two barium oxide (BaO) layers, and a Cu-O chain layer. Other high- T_c superconductors have even more complex structures, some with more than 50 atoms in the unit cell.

One of the goals of advanced materials synthesis is to find ways to increase the upper critical field and the amount of current that a superconducting material can carry before it “goes normal” and loses its ability to carry current without resistance. To drive the upper critical field higher, it is necessary to add scattering centers that reduce the mean free path to the nanoscale.

The ability of a superconductor to carry large current densities is determined by its defect density, because defects “pin” superconducting vortices that cause resistance when they move. The strongest vortex pinning is achieved with dense nonsuperconducting defect arrays, whose optimum size is nanoscale, comparable to the superconducting coherence length. Different defect types affect the current-carrying capability and upper critical field of different superconducting materials. For example, the current-carrying capability and upper critical field of the two classes of cuprate high- T_c superconductors

most useful for applications so far (the first-generation [1G] bismuth strontium calcium copper oxide [BSCCO]-based and second-generation [2G] yttrium barium copper oxide [YBCO]-based conductors) are known to depend on different defect types. Thus, obtaining high current densities and critical fields for a variety of materials will require a panoply of approaches.

Nanoscale Superconducting Architectures

The fabrication of nanoscale superconducting materials has been facilitated by dramatic technological developments over the last 20 years. These advances include thin-film growth with exceptional control by using techniques such as MBE and nanoscale patterning using electron-beam lithography. Progress has also been made in promoting the self-assembly of structures on the basis of biological and chemical processes. Another method to be exploited is beam technology for the production of superconducting nanoclusters at the scale of a few hundred atoms.

Artificially nanostructured superconductors exhibit a rich variety of phenomena that do not exist in bulk materials because of the confinement of the Cooper-pair electrons and vortices. Recent theories have predicted an enhancement of superconducting properties under confinement, resulting from certain types of clustering conditions. Furthermore, if the cluster size is smaller than the superconducting coherence length, the superconductor approaches the one-dimensional confinement limit, and properties such as the upper critical magnetic field can be greatly enhanced. Alternatively, quantum confinement effects could lead to the loss of superconductivity if the energy level spacing within a nanograin (“quantum dot”) superconductor is larger than the bulk superconducting gap. These different possibilities may permit us to tailor the quantum confinement effects by using recent technological advances, such as size-selected clusters. These superconducting quantum dots may thus be used as building blocks to create novel artificial bulk materials.

Barriers to the discovery and use of nanostructured superconductors include the controlled formation of interfaces and surfaces that are key ingredients of artificial nanostructures. Recent advances in characterization techniques will facilitate the study of nanostructured superconductors. For rapid progress, it is important to ensure wide access to these capabilities. These advances include technical improvements in scanning electron microscopy (SEM) and transmission electron microscopy (TEM), such as the development of aberration-corrected SEM and z-contrast TEM. The maturation of techniques such as scanning tunneling microscopy (STM) and spectroscopy at low temperatures and high magnetic fields is another important development. In addition to these atomic-scale surface probes, photon, neutron, and electron scattering probes employing major U.S. Department of Energy (DOE) facilities are essential tools in the suite of critical characterization techniques, because in many cases, they provide information regarding the interior of a sample. There is still a great need for further development of diagnostic and interpretation procedures, especially those capable of nondestructive examination of the properties of buried interfaces.

It may also be possible to exploit modern film growth technology to engineer molecular compounds that do not form by using conventional techniques of crystal growth or bulk synthesis. In principle, this could be an important pathway to inventing new classes of superconductors that operate by as-yet-undiscovered mechanisms. However, unlike their bulk counterparts, these films could provide improved properties as a result of easily tunable parameters advanced by molecular engineering.

The new nanofabrication and characterization techniques outlined above will be important in studying a number of important issues, descriptions of which follow.

Quantum Measurement. Nanostructured materials are small enough that quantum mechanical effects are important. Thus, even the meaning of a measurement (“quantum measurement”) and its interpretation are not straightforward. Moreover, the interpretation of new results requires theoretical modeling. The latter can provide critical guidance for new directions of research.

Proximity Effects. As a consequence of the quantum mechanical character of electrons, electron charges and associated magnetic moments of nanoscaled superconductors can “leak out” from the confining physical structure, causing the properties of nanoscaled superconductors to be influenced by surrounding substrates and “inert” protecting layers. This “proximity effect” can be used as a tuning knob to improve and control the materials properties by placing nanostructured superconductors in contact with normal and magnetic materials. Unfortunately, this same susceptibility of nanoscale superconductors to the proximity effect enhances their sensitivity to environmental factors (e.g., degradation from air or humidity) and ambient electromagnetic radiation (e.g., damage from radiation or radio stations). Serious consideration must be given to physical and electromagnetic shielding, especially in cases where there is high sensitivity to these interferences (e.g., magnetic sensing devices, quantum computing systems).

Understanding Disorder. The current-carrying properties of superconductors are greatly affected by inhomogeneity and disorder, which inevitably occur at the micro and nano scales. In fact, many bulk superconductors are inherently disordered at the atomic and nano scales. The successful synthesis of nanoarchitected superconductors allows us the opportunity to tune these defects at the length scales that directly affect the technologically important superconducting critical currents, and it thereby introduces a new control parameter to improve the materials properties.

Fabrication Technology. Advances in the lithographic methods used to prepare structures with reduced dimensionality have helped enhance the critical current in superconductors by pinning vortices using arrays of magnetic nanodots. An important challenge is to develop techniques for achieving this functionality in a manner compatible with technologically significant processes for fabricating conductors. The transfer of materials-related discoveries into their realization as technologically significant materials, devices, and systems that can be produced cost-effectively and scaled up in size and growth rate is a challenge requiring yet another layer of research and development (R&D).

Electrical and Energy Transport. Charge and spin transport across interfaces is critical to many phenomena in nanostructured superconductors, as they provide the operating principles for many devices. In this context, an understanding of short-time-scale phenomena is also critical. Stable operation of useful superconducting systems depends on effective cooling, which necessitates an understanding of energy transport across interfaces.

Superconducting Clusters. Superconductivity in nanoclusters has been the focus of much attention in recent years. The conventional wisdom regarding these superconducting nanoclusters is that if the average energy level spacing in the cluster is greater than the superconducting energy gap of the bulk material, superconductivity will be suppressed. This would seem to preclude superconductivity in clusters with a few hundred electrons. Recent theoretical work has recognized that the situation is not so simple, because one can, in principle, produce clusters in which the electronic energy states are not equally spaced. In these special clusters, the energy levels are very close to each other and form a shell structure. Similar shell structures were noted some time ago by the nuclear physics community. In the context of superconductivity, recent predictions suggest that this shell structure may lead to pairing of electrons and

superconductivity at extraordinarily high temperatures. In these special clusters with “magic numbers” of electrons, the usual quantum confinement effects that are expected to suppress superconductivity are believed to not be operative.

Theoretical predictions aside, there are serious technical challenges both in preparing clusters of the appropriate size and shape to permit the predicted electron pairing and superconductivity to occur and in demonstrating zero electrical resistance in these small clusters. Many experimental problems occur in producing arrays of clusters of the right size and with a sufficiently tight size distribution, but since the materials science of cluster growth is quite sophisticated, unexpected levels of control may be achieved. Transition temperatures above liquid nitrogen temperature may ultimately be achieved in these nanoclusters.

Potentially useful configurations of nanoclusters would involve arrays or chains of clusters (see Figure 26). It is not known whether the theory that predicted pairing in isolated clusters would, if extended, predict superconductivity in chains or arrays of clusters, or whether the clusters would be coupled sufficiently to allow electrical transport. Furthermore, even if such “chain superconductivity” is theoretically achievable, the implementation of technologically significant wire production could be a major challenge. Research into this question is important, as it could yield to robust superconductivity of a totally unexpected type.

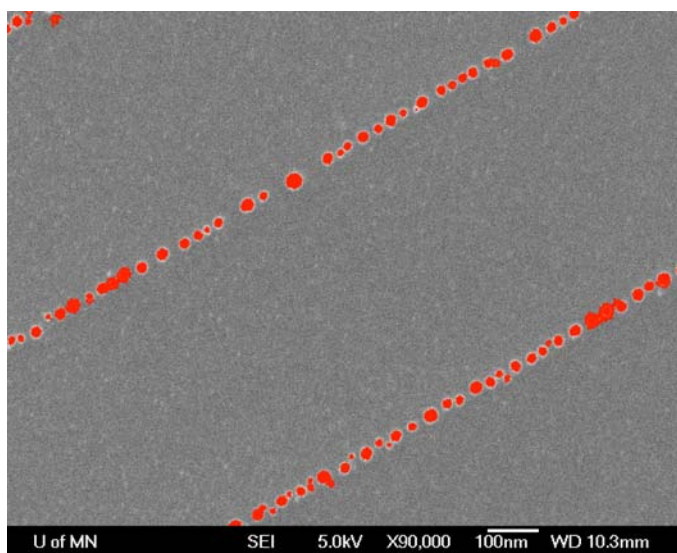

Figure 26 Linear arrays of gold nanodots. The figure shows an array of hemispherical gold (Au) clusters with sizes ranging from 5 to 20 nm. Similar nanocluster arrays can be made of superconducting materials by using novel atomic-scale synthesis techniques. The properties of these “chain superconductors” have not been observed or predicted theoretically.

REFERENCES

J.G. Bednorz and K.A. Muller, “Possible High T_c Superconductivity in the Ba-La-Cu-O System,” *Z. Phys.* B **64**, 189 (1986).

- P.C. Canfield, P.L. Gammel, and D. Bishop, "New Magnetic Superconductors: A Toy Box for Solid-state Physicists," *Physics Today*, p. 41 (October 1998).
- R.J. Cava, H. Takagi, B. Batlogg, H.W. Zanderbergen, J.J. Krajewski, W.F. Peck, R.B. Vandover, R.J. Felder, T. Siegrist, K. Mizuhashi, J.O. Lee, H. Eisaki, S.A. Carter, and S. Uchida, "Superconductivity at 23 K in Yttrium Palladium Boride Carbide," *Nature* **367**, 146 (1994).
- P.P. Edwards, C.N.R. Rao, N. Kumar, and A.S. Alexandrov, "The Possibility of a Liquid Superconductor," accepted for publication in *ChemPhysChem* **7** (September 2006).
- E.A. Ekimov, V.A. Sidorov, E.D. Bauer, N.N. Mel'nik, N.J. Curro, J.D. Thompson, and S.M. Stishov, "Superconductivity in Diamond," *Nature* **428**, 542 (2004).
- L. Gao, Y.Y. Xue, F. Chen, Q. Xiong, R.L. Meng, D. Ramirez, C.W. Chu, J.H. Eggert, and H.K. Mao, "Superconductivity up to 164 K in $\text{HgBa}_2\text{Ca}_{m-1}\text{Cu}_m\text{O}_{2m+2+d}$ ($m = 1, 2, \text{ and } 3$) under Quasi-hydrostatic Pressures," *Phys. Rev. B* **50**, 4260 (1994).
- T.H. Geballe, "Discovering New Superconductors: A Path to New Science and Higher T_c ," in *Strongly Correlated Electron Materials: Physics and Engineering*, I. Bozovic and D. Pavuna (Eds.), SPIE Proc. **5932**, p. 1S, Bellingham, Wash. (2005).
- D. Lederman, D.C. Vier, D. Mendoza, J. Santamaria, S. Schultz, and I.K Schuller, "Detection of New Superconductors Using Phase-spread Alloy Films," *Appl. Phys. Lett.* **66**, 3677 (1995).
- J. Nagamatsu, N. Nakagawa, T. Muranaka, Y. Zenitani, and J. Akimitsu, "Superconductivity at 39 K in Magnesium Diboride," *Nature* **410**, 63 (2001).
- J.L. Sarrao, L.A. Morales, J.D. Thompson, B.L. Scott, G.R. Stewart, F. Wastin, J. Rebizant, P. Boulet, E. Colineau, and G.H. Lander, "Plutonium Based Superconductivity with a Transition Temperature above 18 K," *Nature* **420**, 497 (2002).
- K. Shimizu, H. Ishikawa, D. Takao, T. Yagi, and K. Amaya, "Superconductivity in Compressed Lithium at 20 K," *Nature* **419**, 597 (2002).
- K. Tanigaki, T.W. Ebbesen, S. Saito, J. Mizuki, J.S. Tsai, Y. Kubo, and S. Kuroshima, "Superconductivity at 33 K in $\text{Cs}_x\text{Rb}_y\text{C}_{60}$," *Nature* **352**, 222 (1991).
- M.K. Wu, J.R. Ashburn, C.J. Torng, P.H. Hor, R.L. Meng, L. Gao, Z.J. Huang, Y.Q. Wang, and C.W. Chu, "Superconductivity at 93 K in a New Mixed-phase Y-Ba-Cu-O Compound System at Ambient Pressure," *Phys. Rev. Lett.* **58**, 908 (1987).

PRIORITY RESEARCH DIRECTIONS

Pursue Directed Search and Discovery of New Superconductors	99
Control Structure and Properties of Superconductors Down to the Atomic Scale	103
Maximize Current-carrying Ability of Superconductors with Scalable Fabrication Techniques	109
Understand and Exploit Competing Electronic Phases.....	117
Develop a Comprehensive and Predictive Theory of Superconductivity and Superconductors.....	121
Identify the Essential Interactions that Give Rise to High T_c Superconductivity	125
Advance the Science of Vortex Matter	129

PURSUE DIRECTED SEARCH AND DISCOVERY OF NEW SUPERCONDUCTORS

The search for new superconducting compounds is the very heart of scientific research on superconductivity. The discovery of new compounds has driven the field from its beginning 100 years ago, with landmark discoveries enabling new science and new technologies. Recent experimental and theoretical advances clearly demonstrate that there is a huge potential for discovering new materials that can have significant impact.

EXECUTIVE SUMMARY

During the past 20 years, a vast new chemical and physical space has opened to the search for new superconducting materials, and the research community is now poised to design, develop, and discover new superconductors with greatly improved properties. The search for new superconductors is the archetypical “high-risk, high-payoff” research effort, but given the growing experimental and theoretical appreciation that superconductivity can emerge out of a wide variety of materials classes as the result of a wide variety of mechanisms, the time is ripe to embark on a broad search for new and improved examples of superconductivity.

Chemically, there are large classes of promising materials to investigate. An organized search for superconductivity in binary compounds (compounds composed of only two elements) was carried out in the 1950s and 1960s. Over the last two decades, the recognition that nonmetallic oxide materials could play host to superconductivity led to its discovery in different families of copper oxides as well as in ruthenates and cobaltates. Today, we know that a multiplicity of elements can often lead to complex crystal structures with differing structural parts performing different physical tasks (e.g., a structure in which one array of atoms provides structural stability while another array provides the desired electronic properties), thereby enhancing superconductivity. In addition, given the recent discovery of superconductivity at 40 K in MgB_2 , there is a strong experimental and theoretical motivation to explore compounds that were previously perceived to be too difficult or not promising (e.g., compounds composed primarily of light, reactive, volatile, or high-melting-point elements).

Physically, a much greater control of atomic-level processes now allows for the creation of phases that are not naturally stable. Developments ranging from high-pressure/high-temperature furnaces to sophisticated technology for creating thin films, atomic layer by atomic layer, now allow for the discovery and design of compounds that, while naturally unstable, can be formed and preserved under ambient conditions and can exhibit novel and potentially exceptional superconducting properties.

The convergence of these chemical, physical, and theoretical breakthroughs together with improvements in computational physics now allow for constructive and timely interaction between theory and experiment. Computational predictions may now provide specific guidance to the search for new superconductors. The growing U.S. need for vast improvements in the power grid makes the search for new superconductors with greatly improved properties a uniquely timely and important national priority. One of the goals is discovery of a more ductile and directionally uniform superconductor with an operational temperature of 120 K (-153°C), a readily and cheaply achievable temperature, since it is the boiling point of liquid natural gas. Such a discovery would revolutionize electrical distribution.

RESEARCH DIRECTIONS

Two substantially different methods are now used to search for new superconductors: (1) looking for new combinations of elements in known or new structures and (2) creating arrangements of atoms that do not naturally occur under equilibrium conditions. Any one specific search involving either of these two modes of sample creation is a classic example of discovery research driven by the most basic scientific need to answer or create new questions. A newly discovered material with exceptional properties can almost instantly become the focus of use-inspired basic research or even applied research, as in the case of niobium-based alloys and compounds (enabling technology for current generations of lab and medical magnets), the copper oxides (high-critical-temperature compounds), and most recently, MgB_2 .

Historically, the search for new compounds or structures has followed empirically based intuition arising from vague theoretical guidance. While this paradigm has led to the intermittent discovery of several new superconductors during the past century, it is about to change. The cost of computation has decreased more rapidly than the cost of almost any other commodity over the past decades, and this trend shows no sign of stopping. At the same time, there have been advances in methods for calculating key parameters of materials for superconducting applications. Even though not all theoretical problems have been solved, we have reached the stage where we can exploit computational search, screening, and synergy between theory and experiment to discover materials that can help secure our energy future. An increasingly viable search paradigm establishes tightly interactive teams of researchers whose synergistic skills include synthesis, essential characterization, and materials-specific computation. This approach to the discovery of superconductivity promises benefits now, and even greater benefits in the future, driven by new synthesis capabilities, improved theoretical understandings, and algorithms and advances in computer technology.

Search for New Superconductors

The past 20 years of research have led to a growing appreciation that superconductivity can occur in a wide variety of compound classes, involving mixtures of almost every known element in combinations ranging from two to six elements. Although this describes an innumerable quantity of potential compounds, the past decades of experimental and theoretical research have also delineated particularly promising regions. *The most effective way to explore this huge expanse is to encourage as many research groups as possible to pursue their own differing search strategies*, in essence allowing nature to show us where the next extraordinary superconductors are rather than presuming to know and looking in only one isolated region.

Some of the promising regions to explore include complex copper oxide compounds, as well as oxides with heavier (4d and 5d) transition elements. These compounds, like related heavy fermion (4f and 5f) compounds, may result in superconductivity associated with spin fluctuations or perhaps more exotic mechanisms. In the case of the copper oxide compounds, this could lead to superconductivity that exists at extraordinarily high temperatures.

Another broad class of compounds known as intermetallics is of particular interest since the discovery of superconductivity at 40 K in MgB_2 , a near-doubling of the maximum superconducting temperature of this class of materials. Intermetallic compounds are formed by combinations of metallic and near-metallic elements. They are often more easily workable and offer much cheaper wire technology. The discovery of MgB_2 suggests the possibility of finding even better superconductors in such compounds. One particularly promising category is compounds incorporating combinations of light, reactive, volatile, and high-melting-point elements. Such materials have been poorly explored (because of the difficulties in working with such elements), even though they fit several of the theoretical criteria for potentially high-

temperature superconductivity. It is also worth exploring compounds that have covalently linked networks embedded into metallic hosts (e.g., the graphitic boron sheet separated by Mg layers in MgB_2).

Other promising searches may result from theoretical and computational predictions. These include superconductivity associated with charge fluctuations or onsite repulsion, as well as superconductivity in elemental nanoclusters of well-defined size. In addition, with increasing computation speed and improved models, searches based on specific predictions will create a new, more synergistic approach to discovering new superconducting compounds.

Creation of Artificially Stabilized Superconductors

A salient example of an artificially stabilized material is diamond — a rare and very desirable form of carbon. Although diamond can form at high temperatures and pressures found in the center of the earth, it is not the stable form of carbon on the surface of the earth seen in graphite and coal. (And despite advertisements to the contrary, diamonds are, very slowly, changing back to graphite.) Despite these difficulties, humanity has devised ways of creating synthetic diamond, with great technological and economic impact. There are a number of different ways to create artificially stabilized compounds, many of which include superconductors. One method includes the use of high-temperature/high-pressure furnaces; another method applies sophisticated technology for creating thin films that can be controlled at an atomic scale, using layer-by-layer molecular beam epitaxy (MBE). Imposing very high cooling rates or trapping atoms into unconventional configurations or geometries can create or tailor new arrangements of atoms so as to test existing ideas about superconductivity. Ideally, this will produce truly new compounds or structures with exceptional superconducting properties.

SCIENTIFIC CHALLENGES

The discovery of new superconductors will require the development of new synthesis, characterization, and modeling techniques. The fundamental challenge is to make and measure a wide variety of potentially promising compounds and structures and focus on the ones that ultimately do manifest superconductivity. The large-scale search for new superconductors with improved performance will require the development of new techniques for synthesizing compounds at a variety of extreme conditions: containing and incorporating reactive, volatile, or high-melting-point elements; reacting materials simultaneously at high temperatures and pressures; and synthesizing under high pressures of reactive gases. The creation of artificial structures requires the development of synthetic and diagnostic techniques that will allow for the creation and characterization of compounds in nano, thin-film, and bulk form. There is also the need to devise and implement measurement techniques that will allow for the rapid and accurate screening of new materials for superconductivity, perhaps existing initially only in very small fractions of the sample. In addition, we must refine and implement computer algorithms to guide parts of this wide-scale search.

POTENTIAL IMPACT

The history of superconductivity is punctuated by a series of unexpected discoveries that shattered conventional wisdom and changed the future directions of research. While future scientific endeavor is difficult to predict in advance, the discovery of unexpected superconductors with markedly improved and/or different properties can dramatically change the field.

CONTROL STRUCTURE AND PROPERTIES OF SUPERCONDUCTORS DOWN TO THE ATOMIC SCALE

Refinement of materials properties has been essential to countless advances in science and technology. The growth of highly perfect crystals of many representative compounds in bulk and film form is vital to the basic understanding of superconductivity in existing complex, strongly correlated materials. Understanding and attaining the performance limits of these materials will require exquisite control through advanced synthesis in order to make them either very pure or controllably defective on many length scales, down to the atomic. The interfaces that result either accidentally or deliberately play an essential role in how charge and spin move on these scales.

EXECUTIVE SUMMARY

Among the several thousand superconducting materials that are known to exist, many are not well understood or fully exploited, especially those exhibiting strong electronic correlations. Foremost among these are the layered cuprates, the materials with the highest transition temperatures, for which no generally accepted theory exists. In order to discriminate between competing theoretical models, reproducible samples of many forms are vital, especially high-quality single crystals. However, many of the most interesting compounds contain four or even more elements, some toxic and some with very different melting points and vapor pressures. The challenges faced by the sample growers are considerable! At one extreme is the need to grow large samples (cubic millimeters and larger) of the greatest perfection for refined structural and physical property study. At the other extreme is the desire to grow such samples by thin-film techniques, especially layer-by-layer techniques, such as molecular beam epitaxy (MBE), that allow both great perfection and artificial derivatives of simpler basic structures. Yet another demand is to create intentional and controlled defects and disorder so as to push and understand the limits of the superconductivity possible in high magnetic fields and current densities. Our central goal is to exert unprecedented control over growth so as to reach the limits of performance and achieve a fundamental understanding of the existing complex and diverse superconductors.

RESEARCH DIRECTIONS

Broaden the Range of Available Samples for Fundamental Physical Understanding

Modern superconductors are complex materials, and sizable, high-quality single crystals are instrumental for obtaining their complete physical description. Yet many of the most interesting superconductors have been made only in polycrystalline form or with considerable imperfections. This lack of sizable high-quality crystals is particularly striking for the thallium- and mercury-based cuprates, the materials with the highest superconducting transition temperatures, as well as in recently discovered magnesium diboride. Although single crystals have been produced using state-of-the-art high-pressure synthesis methods, they have lower T_c than bulk polycrystals or films, indicating some extrinsic contributions to their properties. Alloying studies would be greatly enhanced by the availability of high-quality, chemically substituted crystals.

Studies of bulk properties need to go hand-in-hand with studies of thin films. Epitaxial, layer-by-layer growth offers the means both to make highly pure samples that can benchmark single-crystal growth and to tune defects at the atomic scale. Such capabilities are broadly valuable. For example, with regard to the cuprates, the ability to make artificially layered stacks could allow study of the superconducting

condensate at the individual plane level. Quite generally, thin-film growth is particularly valuable for the study of anisotropic materials.

Fine-tune Materials Properties from the Highly Perfect to the Highly Defective

Synthesis of highly perfect superconductors free of disorder and secondary phases is clearly most desirable in order to reach a deep, quantitative understanding of physical properties. A related key question is how robust superconductivity is in the presence of defects. One class of defects consists of those introduced by synthesis under the usual conditions, where starting material purity and interactions with the container may be important. This impurity doping effect is especially important for magnesium diboride, where the high upper critical field values exhibited in some carbon-doped thin films are not yet accessible in bulk form. Understanding such alloying behavior is vital to the goal of developing a conductor that could surpass present niobium-based materials.

Controlled introduction of defects in bulk and thin-film materials enables chemical perturbation of the superconducting materials and requires the application of a variety of sophisticated experimental probes that are essential for understanding the superconducting state and discriminating between various theories of the superconducting mechanism. More practically, such artificially disordered samples can also show how to improve all key parameters, such as the critical temperature, the critical current density, the electronic anisotropy, and the critical field. There is also great interest in studying and fine-tuning materials properties near boundaries to competing nonsuperconducting phases. This is a particularly fertile field for layer-by-layer thin-film growth methods. Optimization of disorder and chemical composition will lead to precise control of other states that compete or coexist with superconductivity. For example, superconductivity exists in close proximity to magnetic ordering in both cuprates and heavy-fermion materials. Reaching a profound scientific understanding of such phases is essential to the quest for the definitive theory of superconductivity in strongly correlated and other complex materials.

Electrical and Spin Transport across Interfaces

The transport of electrical charge and spin across solid-solid interfaces and thermal energy transport across solid-refrigerant interfaces are important in almost all applications under consideration here. Thus, developing a detailed experimental and theoretical understanding of these processes will considerably advance the science related to the development of energy technologies. In the past decade, significant progress has been achieved in our understanding of the special role of interfaces between high-temperature superconductors and other materials. Of particular importance is the discovery of electronic surface states that assist the transport of energy and electrical current across the interfaces in a way that is analogous to the molecules that speed a chemical reaction as catalysts. These electronic surface states (called Andreev states) develop in high-temperature superconductors by a quantum mechanical process called Andreev reflection that is intrinsic to superconductivity, but which has been broadly recognized and understood only in the past decade of research on high-temperature superconductors. Recent research demonstrates that the properties of interface Andreev states are tunable with small electrical voltages and magnetic fields, as well as via the properties of engineered interfaces between superconductors and magnetic materials.

SCIENTIFIC CHALLENGES

Advanced superconductor properties are determined on multiple scales, from the atomic through the mesoscale to the bulk, and their understanding requires synthesis techniques capable of growing thin films, single crystals, and bulk polycrystals with precise compositional and phase control.

Develop Innovative Synthesis Methods for Controlled Growth of Sizeable Crystals and Thin Films of Desired Structure

Innovative technical methods are often essential in paving the way for revolutionary advances. Some key research needs and technical challenges for bulk crystal growth are (1) better control of the temperature gradient and nucleation, (2) more versatile precursor preparation, (3) development of novel solutions, and (4) new crucibles and vapor transport methods. There is a need for new high-temperature and/or high-pressure materials-synthesis and crystal-growth methods, as well. Particularly desirable would be the development of the Traveling Solvent Float Zone Growth method under ultrahigh pressures, because this noncontact method would minimize impurity contamination. High-pressure crystal growth and the development of synthesis methods that can yield nonequilibrium phases are both important for currently known copper oxides and borides, as well as in the search for new materials.

To extend beyond present (often trial-and-error) methods towards a more controlled science of crystal growth, it is desirable to perform in-situ, real-time characterizations during synthesis, as is possible with many present thin-film growth methods. However, this task is often difficult for bulk samples, particularly under the extreme conditions of high pressure and high temperature required for the growth of many crystals. Full utilization of novel synthesis methods has to go hand-in-hand with further exploration of equilibrium phase diagrams for ternary, quaternary, and higher-order phases. Most of the highest transition-temperature compounds in any superconductor class are complex materials that contain many elements (up to six, in the case of the copper oxides). Phase relationships for these complex systems are widely lacking. For the study of heterostructures, including existing superconductors, improved precision of chemical synthesis is needed. This, in conjunction with advanced chemical modeling of metastable materials, will enable the exploration of how the interactions giving rise to high-temperature superconductivity can be enhanced.

A major advantage of thin-film synthesis is that it provides a natural way to assemble samples in which interfaces between different materials set the stage for the emergence of new physical properties. For example, charge carriers can be introduced in a molecular copper-oxygen layer, the backbone of high- T_c superconductors, by engineering the ionic character of an adjacent layer. It is also possible for completely new phenomena to emerge in thin films, which may complement or contrast with the properties of bulk samples. This kind of materials engineering will help reach the goal of attaining the limits of important properties such as the critical current density, the critical temperature, and the critical field.

Bulk single crystals and epitaxial thin films allow for elucidation of the anisotropy in physical properties, which is a characteristic of many of the highest transition-temperature superconductors. This anisotropy is fundamentally interesting, but also generally negative for wire manufacturing and power applications. Large single crystals are crucial for some important experimental probes, such as X-rays and neutrons.

Nanoscaled materials take many different forms, including nanoparticles, nanoparticle arrays, nanoholes, nanorings, nanowires, ultra-thin films, and periodic multilayer films. Their manufacture requires the use of such state-of-the-art fabrication tools as nanolithography, molecular beam epitaxy, self-assembly, and cluster growth technology. Unfortunately, many (if not all) of these sophisticated techniques are not easily amenable to mass production, which is essential for the transition from interesting research phenomena to the types of applications envisioned here. Therefore, developing alternative fabrication methods and novel schemes for the production of large quantities of nanostructured materials is a major challenge.

Control of Grain Boundaries and Interfaces

The properties of interfaces are a central concern pertaining to all advanced superconductors. Grain boundaries are particularly important, because they are inherent to all polycrystalline and large-scale

forms. In general, superconductivity is suppressed at grain boundaries, but for the classical materials currently used in superconductor power applications, this suppression is not a major problem. In cuprates, however, grain boundaries significantly obstruct current flow and strongly reduce the critical current. In cuprate wires, it is essential to minimize the grain-to-grain misorientation, as any practical wire has to approximate the vision of “single crystals by the mile.”

Although it used to be thought that such obstruction was an inherent consequence of nanometer coherence lengths, it is now clear that it is the doped parent insulating state of the cuprates that makes grain boundaries bad for current flow. A major opportunity to understand the electronic and structural states of low-angle grain boundaries, using modern growth methods supported by atomic-resolution analytical electron microscopy, is now at hand, especially when this includes studies of the effect of intentionally introduced impurities and geometrical modifications (such as fabrication of meandering grain boundaries, as opposed to straight ones) on the transport properties. Scanning tunneling microscopy is a very powerful technique for directly probing electronic and superconducting states that has yet to be applied to grain boundaries.

Layer-by-layer growth using such techniques as MBE offers opportunities to produce artificial interfaces that may have much to offer to the study of grain boundaries. It is possible to assemble existing superconductors, as well as a wide variety of other materials, in the form of multilayer samples that exhibit new properties at interfaces. Properties that can be expected to impact superconductivity in an adjacent layer include the electronic and magnetic polarizability, electron spin order, and the occurrence of other correlated electronic phases. All of these factors are found in other oxide phases that have structures similar to the cuprates. Progress in the synthetic chemistry of heterogeneous interfaces is needed to fully explore what properties cuprate multilayer samples can attain. To date, interfaces between a few crystalline insulators and cuprate compounds have been shown to assemble homogeneously, but important aspects about this process remain unknown and require further intense investigation.

A number of important challenges and significant barriers exist, which make the use of nanostructured superconductors and the discovery of new superconducting properties daunting tasks, including the control of interfaces and surfaces that are key ingredients in the fabrication of nanoscaled superconductors. It should be emphasized that even characterization at the nanoscale is very challenging because many of the available techniques have serious technical difficulties in providing a detailed atomistic description at this length scale. Here many of the existing and planned major DOE facilities (such as neutron and synchrotron sources), with their capabilities of element-specific short length and time-scale characterization, are expected to play the key role.

Important length scales (physical size, chemical modulations) in these novel materials are short enough that quantum mechanical effects become important. Because of this, even the meaning of a measurement (“quantum measurement”) is not straightforward. Moreover, the prediction of new properties and the interpretation of new results must await developments in theory and modeling. Theory, in addition, could provide guidance for new fruitful and enlightened directions for exploration.

Characterization at the nanoscale requires the use of sophisticated tools such as X-ray and neutron sources and computer-intensive simulations to interpret the data obtained from these machines. The quantitative understanding of these materials at the nanoscale will be crucial to improving their properties and to properly integrating them into useful devices. An important challenge is the development of techniques that permit the characterization of buried structures at the atomic scale and at short time scales. The main difficulty to be overcome is that experimental methods do not provide direct atomic-scale images, but rather complicated information that demands computer-intensive interpretation and methodology. Techniques such as atomic-scale holography, structural refinement, inelastic scattering, and deconvolution methods, combined with complementary techniques, are needed to determine

quantitatively the atomic-scale physicochemical structure that determines the properties of nanostructured superconductors.

POTENTIAL IMPACT

Exquisite control of structure and properties down to the atomic scale is vital to growing the samples that will allow discrimination between competing models of superconductivity in strongly correlated systems. Understanding the mechanisms that permit superconductivity at formerly undreamt-of temperatures and magnetic fields will be invaluable in the quest for as-yet-undiscovered superconductors. Current applications of superconductors demand the widest possible domain of magnetic field and temperature in which superconductivity exists. Quite generally, this requires purpose-driven engineering of defects on the nanoscale that can be achieved only through well-understood materials growth.

MAXIMIZE CURRENT-CARRYING ABILITY OF SUPERCONDUCTORS WITH SCALABLE FABRICATION TECHNIQUES

The utility of practical superconducting electric-power conductors depends on both their performance and their cost. Maximal performance is governed by the fundamental limits of the material and by our ability to exploit these limits. Raising the performance ceiling reduces the cost and/or increases electrical capacity; however, ultimate cost reductions must exploit performance limits within inexpensive manufacturing processes. The scientific understanding needed to achieve these two goals is primitive at best.

EXECUTIVE SUMMARY

Present second-generation (2G) superconducting electric power conductors based on yttrium barium copper oxide (YBCO) operating at liquid nitrogen temperature are at the threshold of the performance needed for power transmission cables, but they fall short of the performance needed for transformers and rotating machinery (Figure 27, left). On the other hand, the current performance of coated conductors is well below their theoretical limit (Figure 27, left and right); therefore, there is headroom for improvement. Theoretically, YBCO-coated conductors operated at liquid nitrogen temperature could enable the full range of electric-power applications. What is needed to maximize their performance is a fundamental understanding of vortex pinning in coated conductors in all of its aspects and an understanding of the thin-film growth processes needed to grow coated conductors at low cost. This discussion of priority research directions addresses these issues.

A central theme involves understanding the vortex pinning mechanisms in YBCO and how they can be optimized toward the fundamental limit indicated. For any superconductor application, the currents they carry and the magnetic fields they produce cause penetration of magnetic vortex lines into the

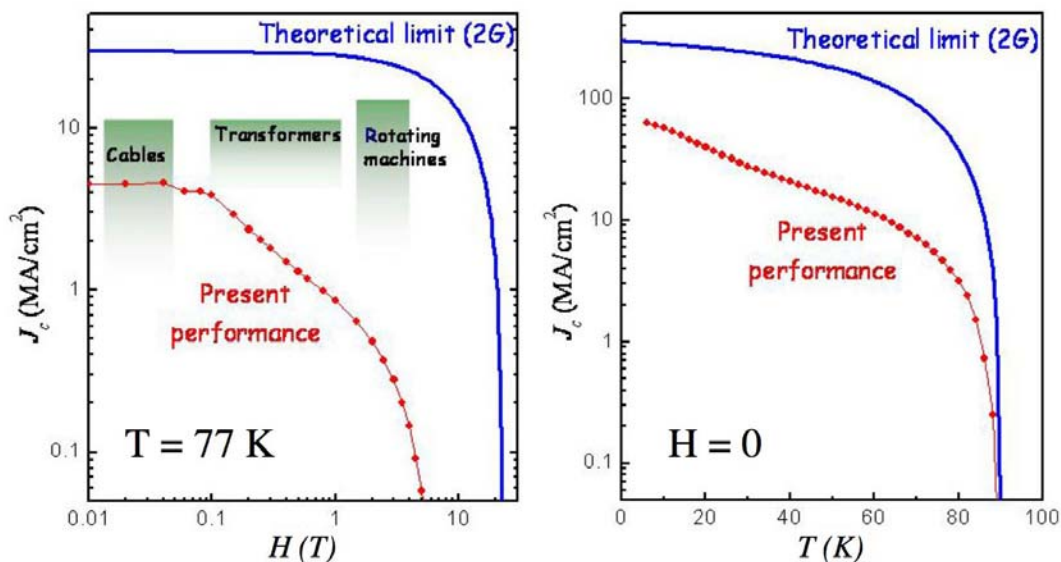

Figure 27 Left panel: Magnetic field dependence of the critical current density, J_c , in a present high-quality YBCO-coated conductor (red dots), at the benchmark temperature of 77 K, the boiling point of liquid N₂. The solid blue line is the highest possible J_c that could be achieved in YBCO based on fundamental physical limits. Right panel: Temperature dependence of J_c at zero magnetic field.

superconductor (see description in Panel Survey: “Basic Research Challenges for Vortex Matter”). Were it not for an attractive (pinning) interaction between the vortices and defects in the superconductor, these vortices would lead to a finite resistance in the presence of an applied current. There are a plethora of defects in YBCO, including internal interfaces, precipitates, and structural disorder. However, the optimum defect arrangements are not known, because of the complexity of vortex behavior, the huge variety and number of defects, and the myriad possibilities for the pinning mechanism. A key property of vortex matter is the subdivision of superconductivity on a scale from a few to a few tens of nanometers. This suggests that pathways toward basic improvements lie in YBCO materials that are uniformly heterogeneous on the nanoscale but are otherwise very homogeneous at larger scales. Indeed, by implementing this principle in liquid-helium-based superconducting technology over the past three decades, advances such as medical imaging magnets and particle accelerators became possible.

A complementary focused theme involves understanding the materials science of the growth mechanisms of coated conductors such that one could engineer the required pinning nanostructure and identify the growth processes that are potentially fast and therefore economical. Given that the present development level of coated conductors corresponds typically to a single-phase superconductor with a wide range of naturally occurring defects, attaining sufficient control of the growth parameters to produce nanostructures having multiple phases would be a huge achievement — one that could result in enormous increases in the performance of superconducting power conductors.

Implicit in these themes is the recognition that understanding the growth mechanisms could also help simplify the complex conductor template architecture and produce ways to make the conductor filamentary or with a lower aspect ratio in order to reduce alternating-current (ac) losses.

RESEARCH DIRECTIONS

Model Systems for Pinning Studies

The defects that pin vortices govern the current-carrying capacity of any superconductor. In practical coated conductors for superconducting power applications, the principal defects responsible for pinning are not well understood. Part of the reason for this central problem is the complexity of their microstructure (see sidebar, “Some Vortex Pinning Structures in Coated Conductors,” in Panel Survey: “Basic Research Challenges for Vortex Matter”). Here, at least four different candidates for flux pinning have been identified. In addition, there are other candidates, such as oxygen-site defects, that are not revealed by this probe. Furthermore, the situation is compounded by the limited quantitative understanding of the effectiveness of each of the candidate pinning defects and the detailed mechanism by which they interact with magnetic vortices. It is not clear whether multiple defects can exhibit combined effectiveness, or whether a certain hierarchy applies to microstructures with multiple pinning types. A final complication is the fact that the pinning effectiveness of a specific defect is not just the single-defect/single-vortex interaction but also depends on the interactions of the vortices with one another — in short, vortex pinning is a many-body problem.

Given such complexity, it is desirable to reduce the problem to the quantitative study of the effectiveness of specific defect types. With this knowledge, it then becomes clear how to either progressively combine them to establish their collective effectiveness or isolate the best pinning sites and remove the others.

Therefore, synthesis of model systems for pinning studies should be a primary research direction. These studies should be closely coordinated with structural characterization, including electron microscopy and electromagnetic property measurements, such as determination of the critical current density (J_c , the current at which the Lorentz force on the vortices due to the current is balanced by the pinning forces in the material) and its boundaries as a function of temperature, magnetic field, and orientation in the

field. Key to success is the development of model systems in which a specific defect type (or types) is introduced in a controlled way and thus can be studied unambiguously.

Quantitative Determination of the Pinning Landscape

The arrangement of pinning centers in a superconductor produces spatial variations of the potential energy of vortices as a function of position. Analogous to the potential energy variation of hills and valleys, this pinning “landscape” embodies the complete pinning potential, including the cooperation or competition between various kinds of pinning centers. Basic research is needed to identify the various operative defect classes and to quantify their effect as pinning centers. This includes characterizing the nature and distribution of the defects, measuring their individual pinning strengths, and establishing the underlying physics of their pinning mechanism(s).

The balance between the Lorentz force due to the current acting on the vortices and the pinning force caused by the defects acting on the vortices provides two avenues for gathering information about vortex pinning. Traditionally, the Lorentz force is the starting point, using experimental measurements of the critical current density, observations of the nanostructure under various conditions, and theoretical models to infer the microscopic pinning parameters. It is important to continue this approach for 2G YBCO superconductors.

At the same time, new tools (such as scanned nanoprobes) now permit studies of vortex pinning to be initiated from the perspective of the pinning force. Here, the input information is experimental measurements of the individual pinning interaction between a single vortex and a single defect. The ability to image, manipulate, and measure the forces on individual vortices in thin films has been already demonstrated. The next step is to carry out such measurements with a specific, identifiable defect type — a major but high-payoff challenge, indeed. Moreover, if such measurements can be extended to higher vortex densities, the effect of interactions between the vortices in specific pinning landscapes could also be investigated directly. Such information would be a critical input with which to test realistic theories of vortex pinning that include both the pinning landscape and the interactions between the vortices. At present, this challenging many-body problem limits the efficiency of approaches started from the Lorentz-force side. Clearly, cross-implementation approaches from both avenues could provide breakthroughs in our understanding of the most important aspects needed for performance.

Further, atomic-resolution probes exist, such as scanning tunneling microscopy (STM) and scanning tunneling spectroscopy (STS), and more are under development (e.g., scanning Josephson microscopy), which have demonstrated a capability to measure the local superconducting properties of these materials. STM and STS have been applied with great success on cleaved single crystals of bismuth strontium calcium copper oxide (BSCCO) to reveal small-scale variations of the superconducting properties of unknown origin. For the purposes of understanding the pinning landscape, sweeping such probes across the surface of a superconductor will provide a direct map of the pinning landscape in the absence of vortices. Their use on YBCO presents additional challenges to prepare suitable surfaces, but the payoff could be very high, particularly if the kind of variations found in BSCCO are also present in YBCO and, moreover, if they are found to play a role in vortex pinning.

3-D Defect Imaging

A traditional transmission electron microscopy (TEM) study provides only a section through the pinning landscape. Looking forward, new capabilities that permit three-dimensional (3-D) imaging of the pinning landscape are being developed, which have the potential to improve dramatically our ability to visualize and quantify the pinning landscape in three dimensions. An example of such a 3-D image is shown in

Figure 28. Such 3-D information would be very useful as the starting point for computational models of vortices in realistic pinning landscapes. At present, such models are restricted to ideal or repetitive arrangements, and few models address truly 3-D vortex systems.

At present, the spatial resolution of scanning electron microscopy is ~ 10 nm. Further extension to atomic-scale regimes is needed to enable a comprehensive accounting over all length scales of all of the defect types that occur in coated conductors and may contribute to pinning of vortices. In addition to these refinements, complementary information is needed, such as whether the defects are coherent or incoherent with the superconducting lattice or the types and extent of strain fields emanating from them.

Dynamic Imaging of Vortices

Given a pinning landscape, it is important to understand how vortices collectively distribute themselves and how they move through the landscape under the influence of a transport current. The prevailing view is that, at least initially, the vortices move plastically along weak channels in the pinning landscape (including vortex-vortex interactions), followed by uniform motion en masse at much higher currents. Since some of the vortices remain pinned up to the regime of uniform vortex motion, coordinating studies of both moving and pinned vortices will help improve the performance of real conductors. At the opposite extreme, a deep understanding of these processes is at the forefront of the physical understanding of vortex matter. Hence, this research direction is of both fundamental and practical interest.

New methodologies are being developed that permit the imaging of static and dynamic vortex processes at low vortex density. Improvement is needed to extend these to higher vortex density and higher resolution. They include Lorentz microscopy, advanced forms of magneto-optic imaging, scanned thermal probes (which locally heat the superconductor and image vortex matter upon cooling), and scanned magnetic probes of various sorts. Each has utility in its natural domain of spatial and temporal resolution.

Nanoengineering of Pinning Landscapes

Basic research that will enable ideal pinning landscapes to be transposed onto “real world” conductors via synthesis will result in tremendous improvements to superconducting electric power conductors. Ultimately, this may make it possible to tailor the critical current to the specific field and temperature regimes for a given conductor application. As such, a variety of methods of pinning engineering are desired.

Basic research is needed to improve understanding of the materials science and chemistry related to synthesis. Accessible routes toward nanoscale pinning landscapes that have been explored include atomic substitutions to form secondary phases, using multilayering of thin YBCO films separated by very thin

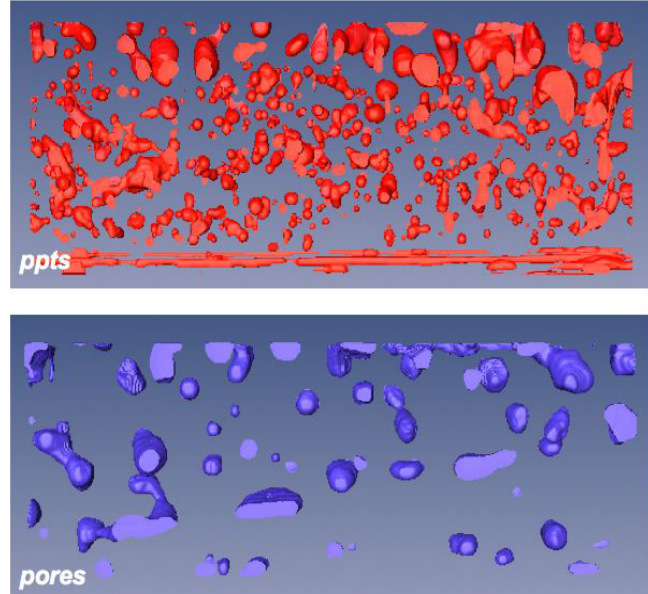

Figure 28 3-D reconstruction of the microstructure in a YBCO-coated conductor based on focused ion beam (FIB)-scanning electron microscopy (SEM) tomography. The total depth of the precipitates (ppts) and pores depicted here is ~ 1 μm (into the plane of the paper). (Courtesy of D. Miller, Argonne National Laboratory)

nonsuperconducting CeO_2 epitaxial films and site-specific substitution of rare-earth cations in the superconductor. Figure 29 illustrates one example of how Sm and Eu substitution for Y influences the pinning force and film microstructure at 77 K. In this case, improvements come from the added headroom, by moving the boundaries of the superconducting state to a higher critical temperature and irreversibility field, and from the enhanced pinning due to variations of the superconducting state.

Much less is understood about the possibilities for designing multiphase nanostructures. Potential routes for basic research include phase separations, spinodal decomposition, intercalation, and liquid-assisted formation of secondary phases. Basic materials science and growth studies are needed to understand and develop novel synthesis routes for incorporation of nanometer-scale precipitates. Synthesis routes should control their density, type, correlation with other defects within the crystal lattice, and compatibility with the superconducting YBCO. Also, pinning centers should be compatible with growing film under nonequilibrium conditions. An example is the introduction of zirconium together with a barium-containing precursor, which led to the formation of barium zirconate rods only a few nanometers in size. These are very strong pinning sites; however, they also degrade the boundaries of the superconducting state somewhat, although it is not known whether this is a result of doping, lattice strain, or some other effect.

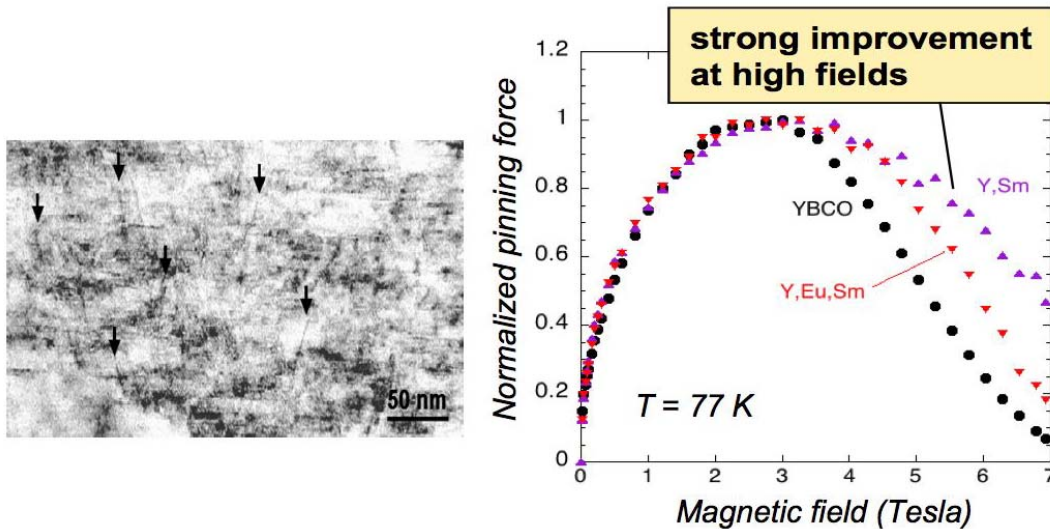

Figure 29 Left: Cross-sectional TEM of Sm-doped YBCO film. The arrows point to inclined correlated line defects. Right: Normalized pinning force vs. magnetic field comparison of YBCO films with rare earth-mixture films.

Architectures of Conductors

The implementation of flat superconductors in time-varying magnetic fields produces ac losses that could offset many of the benefits of high current density. Experience with low-temperature superconductors shows that stabilized, filamentary, and transposed conductors are requirements for such applications. While there are engineering solutions, such as using laser patterning to cut a YBCO film into filament patterns, basic research could enable such breakthroughs as the direct writing of filaments or manipulation of multiphase nanostructures to produce filamentary geometries.

In addition, to a large degree, the cost of YBCO-coated conductors and the complexity of their science stem directly from the complexity of the conductor architecture. Basic research to simplify and add

multifunctionality to the substrate could produce significant advances, or at the very least, the removal of layers of complexity. Substrates that induce filamentary patterning or provide stabilization would also be helpful.

Fundamental Science of Growth and Nanostructure Development

Fabrication of YBCO conductors at an industrial scale must ultimately use high-rate deposition techniques. Inherent to these techniques is a tendency away from thermodynamic equilibrium and toward kinetic processes. As the first seeds of what will become the superconductor form, several intricately linked and individually complex problems are already active, including nucleation, atom mobility, adhesion, chemical reactions, lateral and transverse growth, and substrate and interfacial effects. The large number of related processing variables (temperature, time, flux of reactant atoms, substrate conditions, composition of precursors, processing environment, removal of by-products, etc.) presents a phase space that is presently intractable for systematically achieving significant performance improvements. Indeed, although incorporating a second nonsuperconducting phase together with YBCO to increase flux pinning could produce sharply higher current-carrying capacity, single-phase films deposited at high rates also achieve current densities $>3 \text{ MA cm}^{-2}$, indicating that the baseline superconductor itself can contain a high population of defects for good flux pinning.

Basic research into growth mechanisms is needed to understand the influence of different processing variables on the nanostructure and properties of the superconductor. *Inasmuch as other research directions below seek improvement over the baseline, basic research here underpins anticipated progress in many other research areas.*

Understanding the factors that control the size and separation of seed crystallites is a second important research component, because they determine the morphology of the layers that will form later. In some situations, especially when the YBCO film is grown by the conversion reaction of a precursor film, it is plausible that a liquid phase participates in part or all of the film growth. Liquid phases offer several advantages, such as epitaxial growth and rapid atom transport. However, phases solidified from the melt remove solute, which must be replenished to keep the system within phase boundaries. Further research into liquid-assisted growth modes is thus desirable.

The tremendous amount of research on YBCO film growth has produced a variety of different routes that result in comparable properties. This advantage drives innovation. However, there is little understanding of the relationship between properties and the growth process. Basic research is needed to further address this area. In addition, coordination with property measurements to the full boundaries of the superconducting phase is important here, because of the sensitivity of performance at 77 K to the critical temperature and irreversibility field (which is a function of temperature).

SCIENTIFIC CHALLENGES

Coated conductors are arguably one of the most complex materials ever developed for technology. Moreover, they require single-crystal-quality film growth over kilometers of practical conductor. As such, their development and optimization stretch our scientific understanding and push our ability to fabricate materials in useful form (e.g., epitaxial growth on a large scale). At the same time, the scientific challenges are such that meeting them is leading to the development of entirely new tools (e.g., 3-D imaging of microstructures and nanometer-scale scanning probes for physical measurement) and is advancing the frontier of statistical physics (vortices in complex pinning landscapes). Hence, the

scientific challenges of coated conductors are not just of interest for their own sake; they are advancing materials science in general. Some critical barriers to reaching the maximum achievable J_c levels are:

- Understanding the pinning mechanisms for specific defect types.
- Understanding factors that affect the background vortex pinning (natural to YBCO itself) and those that are incorporated by additions to the system.
- Understanding the interaction of multiple defect types (the pinning landscape).
- Understanding how the vortices accommodate the pinning landscape under a driving force (i.e., as a function of applied current).
- Controlling the growth of multiple phases to promote those defects that improve pinning, while eliminating those that weaken superconductivity.
- Controlling growth mechanisms to produce ideal pinning nanostructures.
- Controlling the growth of different phases and their orientations to modify conductor architecture and optimize its usefulness.

POTENTIAL IMPACT

Success in the research described above would provide a basis for greatly improved performance of the 2G conductors presently under development and lead to lower costs. The increase in performance would enable additional applications of 2G technology and provide the science base with which economical industrial processes could be selected and optimized. This knowledge base gathered from studies of existing materials would also provide a basis for optimizing the revolutionary new materials (for future generation conductors) obtained through further search and discovery.

UNDERSTAND AND EXPLOIT COMPETING ELECTRONIC PHASES

With regard to the presently known novel superconductors, the superconductivity phase is just one of several competing electronic phases (e.g., magnetically ordered or electrically insulating phases) that can be used as new “knobs” to “tune” the performance of superconductors. However, the underlying principles that govern the interplay between these competing phases are unknown, and new experimental and theoretical initiatives are needed to discover them. These principles could eventually be used to help guide the search for superconductors that perform better in terms of critical temperature, magnetic field, and current density.

EXECUTIVE SUMMARY

To improve and eventually surpass copper oxide superconductors, we need to understand the essential principles underlying superconductivity. One approach is to try to directly understand the electron pairing mechanism. This challenge, however, is currently one of the most profound in all of condensed matter physics. Another approach is to look for phenomenological similarities among known families of unconventional superconductors and then consider them in the search for new and improved superconductors. Researchers in this latter area have recently identified a pattern of competing electronic phases that are close to the superconductivity phase when certain parameters (e.g., chemical composition, magnetic field, pressure) are varied. This discovery is behind our proposed new priority research direction: to have these competing electronic phases direct the search for new high-performance superconductors. First we propose to explore the coupling between superconducting and competing phases to determine whether it can be manipulated to achieve improved properties, such as higher critical temperatures or better vortex pinning for improved critical currents. The second avenue we propose is to identify promising materials that exhibit particular types of electronic order, then determine whether superconductivity can be induced by perturbing or frustrating that order by tuning the electronic order toward extinction by applying extreme conditions (e.g., very high electric/magnetic fields, pressure/stress, or chemical composition).

RESEARCH DIRECTIONS

Search for New Quantum Phases of Matter

Unusual spatial modulations of atomic charge and spin densities have been observed in several families of copper oxide superconductors. Patterns in the form of periodic stripes and checkerboards have been observed, with typical periods of four lattice spacings (or about 2 nm). The appearance of these patterns tends to correlate with the suppression of superconductivity, and it can be affected by various factors, such as small distortions of lattice structure, applied magnetic fields, chemical defects, and lattice strain. There are many new avenues of research related to these unusual states of matter and their interplay with superconductivity, and they need to be urgently pursued. Among the important outstanding issues to be addressed are the following: (1) Are stripe and checkerboard orderings distinct states of matter? (2) Can dynamic, fluctuating versions of such states exist, and can they coexist with superconductivity? (3) Is there a connection between the electronic interactions that are responsible for the modulated structures and those that drive the superconductivity? (4) What chemical, structural, and electronic features are essential for stripe or checkerboard states to occur?

Other unusual states of quantum matter (such as the d -density wave, the staggered flux phase, and a state with local orbital currents between neighboring copper and oxygen atoms) have been proposed

theoretically. These proposals have been motivated by attempts to understand the so-called “pseudogap” phase of copper oxide superconductors. The challenge is to detect such states in experiments. Unequivocal experimental evidence for such new types of ordering would have a revolutionary impact on our understanding of electronic collective states closely coupled to high-temperature superconductivity.

Pressure and Magnetic-field Tuning of Transitions between Superconducting and Competing Phases

An emerging trend that has been identified from observations of exotic superconductors is that the maximum transition temperature for superconductivity occurs under conditions that cause the transition temperature for a competing order (such as antiferromagnetism or a charge density wave) to go to zero. This behavior is seen in a number of heavy fermion compounds as a function of pressure and magnetic field, and it is seen in organic conductors as a function of pressure and chemical composition. The copper oxides follow the same trend, if one considers the pseudogap phase to represent some sort of competing order. An important practical issue to address is whether the superconducting properties of a given material, after they have been optimized with one variable, could be further improved with a second variable. A broader question is whether a general principle underlies the relationship between superconductivity and competing orders. We propose several new research initiatives, including these: (1) determining if disordering of the competing phases by quantum fluctuations plays a role in superconductivity and (2) determining if the nature of the competing order provides information about the mechanism of pairing in the superconducting state.

The empirical connection between superconductivity and competing types of order points toward new opportunities to search for novel superconducting materials. The scheme will be as follows. First, identify a compound known to have an interesting type of ordered state, such as antiferromagnetism. Then, attempt to frustrate or extinguish that order through chemical substitution, pressure, epitaxial strain, field-effect doping, etc. Once a superconducting phase is discovered, optimize its properties by tuning other variables. Of course, in order to obtain superconductors with improved properties, a key concept in this approach is to make a thoughtful selection at the start. For example, one of the limiting features of copper oxide superconductors is the extreme anisotropy of their transport properties. It would be much easier to make wires from an isotropic material. Thus, one could choose to start with a compound having a cubic structure, with the intent being to discover a new isotropic superconductor.

Manipulation of Competing Phases for Improved Vortex Pinning and Increased Critical Current Density (J_c)

Measurements made by using a number of experimental techniques, such as scanning tunneling microscopy and neutron scattering, have provided evidence of competing order (checkerboard or stripe phases) in association with superconducting vortices. This discovery raises the possibility that one could pin vortices by coupling them to the competing phase. For example, on top of a superconducting thin film, one could pattern a normal state structure with a spatial anisotropy that would couple to the orientation of patches with checkerboard or striped ordering. The first objective would be to show that one could improve vortex pinning. The second would be to find technologically practical schemes for employing such effects.

SCIENTIFIC CHALLENGES

The topics in this priority research direction are associated with areas of basic discovery research; they all represent scientific challenges in and of themselves. But beyond and related to these challenges is another

one: developing the new experimental capabilities required to conduct this research. For example, a major issue concerns the role of electronic inhomogeneity in superconductors close to a transition to a competing type of order. Existing techniques, such as bulk-sensitive neutron and x-ray scattering and local scanning probes, can detect static inhomogeneity at the atomic scale. However, if spatial variations fluctuate with time rather than remaining static, they are much more difficult to detect. Still another challenge is the need to develop theoretical modeling so that more information can be extracted from existing experimental techniques. A cross-cutting challenge is the continued development of techniques for growing samples, especially single crystals and epitaxial films that can enable a broad range of experimental characterizations and tunings.

POTENTIAL IMPACT

An understanding of the relationship between superconducting and competing electronic phases that would enable their behavior to be predicted would revolutionize condensed matter physics. Even without such a detailed understanding, knowledge of the empirical connections could lead to the discovery of new superconductors with properties of great value in meeting U.S. energy security challenges. An understanding of the sensitivity of the superconducting state to pressure and magnetic fields would also be very relevant to the engineering of new machines and power transmission systems based on superconductivity. Research in this area would also expand the knowledge base for other applications that require the development of materials having other technologically important properties, such as magnetoresistance.

DEVELOP A COMPREHENSIVE AND PREDICTIVE THEORY OF SUPERCONDUCTIVITY AND SUPERCONDUCTORS

An understanding of the pairing of electrons and their coalescence into a state of matter that conducts electricity without loss not only constitutes the conceptual underpinning of superconducting technology but is also fundamental to materials physics. Building predictive theories based on this knowledge of underlying pairing mechanisms provides a path for fully identifying and realizing the remarkable possibilities of the superconducting state and its technological impacts.

EXECUTIVE SUMMARY

The aim of the proposed research is to achieve a full understanding of the foundations of high-temperature and exotic superconductivity (“theory of superconductivity”) and to develop theoretical tools for achieving a complete quantitative understanding of the principles controlling the superconducting properties of individual materials.

Realizing the technological promise of superconductivity — which is largely to improve the energy efficiency of electricity generation, transmission, and utilization — depends on identifying specific new materials with the properties — critical transition temperature (T_c), critical current density, and critical magnetic field — needed for superconductivity. Progress in this area also depends on accurate theoretical and computational models of transport in superconducting materials with interfaces and defects. Optimization of the critical current density and critical magnetic field strongly relies on identifying the material parameters responsible for suboptimal performance. There are three primary avenues to pursue. The first is associated with *conventional* superconductors. For these superconductors, a detailed quantitative theory that accounts for the specific properties of the underlying material is available. The challenge is mainly to improve existing algorithms and develop new ones for broad-scale computational screening of new materials and to extend the theory to materials with extremely strong coupling, strong anharmonicity, and/or high-energy scales. The second avenue is associated with *exotic* superconductors. For these superconductors, the mechanism of pairing must first be understood, ultimately at a material-specific level, in order to advance their technological impacts. The third avenue lies in developing theoretical and computational formalisms to describe the processes that occur at the contacts and interfaces between superconductors and normal metals, including nanoscale superconductivity and transport.

RESEARCH DIRECTION

Electron Phonon Superconductors

Extending the variety and diversity of superconducting materials is essential to the quest for better superconductors. The period 1960–1980 provides a counterexample: Although tremendous work went into the study of a single specific class of transition-metal-based intermetallics (typified by Nb_3Sn), the increase in the maximum value of T_c from 1955 to 1986 was only 6 K. The cuprates, the bismuthate $\text{Ba}_x\text{K}_{1-x}\text{BiO}_3$, and the fullerides each demonstrated new routes (material classes) to higher-temperature superconductors. The present challenge is not only to understand and exploit these existing materials but also to look toward the future to improved materials. These are most likely to be found as the result of a rational search for new classes of superconductors that is based on a combination of experiments, theoretical understanding, and material-specific computational tools.

The latest revolution in superconducting materials is represented by the discovery of MgB₂ with a critical temperature of 40 K and by the ability of theory to provide an almost immediate understanding of this material's unique characteristics. This finding has revitalized the quest for superconductivity in wider classes of materials, suggesting a possible path to a substantially higher T_c , which could perhaps lead to room-temperature superconductivity. MgB₂ has a highly unusual combination: very strong covalent bonds in which the electrons are metallic rather than insulating and — the important ingredient — light constituent atoms. The pairing mechanism is known to be due to atomic vibrations, and their frequency determines the scale of the superconducting T_c . This frequency (and resulting T_c) is higher for lighter atoms. The theoretical understanding of MgB₂ is leading to specific suggestions for designing materials with similar underlying characteristics but with differences that incorporate more atomic vibrations into interactions and thereby enhance the coupling strength. This new understanding has brought renewed optimism and the expectation that when it is coupled with a strong effort in materials synthesis, new and better superconductors will be discovered. For example, inspired by MgB₂, researchers recently showed that diamond, when appropriately doped, becomes superconducting.

A different paradigm for high-temperature superconductivity is provided by a discovery that has been made in just the past three years — that a very simple elemental metal, Li, which normally has none of the characteristics of a good superconductor, nevertheless evolves into the highest-temperature elemental superconductor ($T_c = 20$ K) at high pressure (500,000 atmospheres). Existing computational theory, which provides a quantitative understanding of the change of Li from being nonsuperconducting to an excellent superconductor, also enables the exploration of material properties under extreme pressure. Much additional insight that can guide the discovery process can be gained from this effort. Specifically, once novel properties of matter at high pressure are understood, they are often realizable at normal ambient pressure by using appropriate chemical and structural modifications to mimic the effect of pressure. Applications of theory to search for and understand high-pressure superconductivity require particularly precise methods, because only a limited amount of data on phonons, structure, and other properties of high-pressure phases can be obtained from experiments. High-pressure superconductivity is an excellent proving ground for theory and can no doubt offer many interesting surprises that might lead to new paradigms for ambient-pressure superconducting materials.

We foresee the following scientific challenges along this route (and in the field of conventional superconductors in general). First is the need to adapt and extend the computational algorithms for crystallographically complex materials in order to enable massive screening of the material parameters that define superconductivity: electronic structure, lattice dynamics, electron-phonon coupling, and spin dynamics. Then the theory needs to be extended in order to address “problem materials” in which (1) the motion of the electrons cannot be separated completely from the motion of the atoms, (2) the atomic vibrations themselves become anomalous, and (3) the coupling between the charge carriers and the vibrations moves from strong to ultrastrong. Each of these conditions represents a situation in which a material is being “pushed to its limits,” a scenario that has often been observed to lead to the best superconductors within a materials class. In principle, these effects are reasonably well understood at a qualitative level, but their mathematical and computational implementations are not easy. The third challenge is to include in the *ab initio* calculations the direct Coulomb repulsion at the same level of accuracy as the phonon-induced attraction. A promising new direction here is the density-functional theory of superconductivity, which has already been successfully applied to several elemental materials as well as to MgB₂. A very important factor with regard to the use of these theories is that the computational power at U.S. Department of Energy (DOE) supercomputing centers has become sufficient to support a broad computational search for candidate superconductors.

Last but not least, while a standard theory of superconductivity for conventional electron phonon superconductors is in hand, a proper description of the contacts and interfaces between superconductors and normal metals (which are unavoidable in practical applications), and of the transport of electric

current across such interfaces, is a separate theoretical effort. Indeed, optimizing electric current capacity depends on our ability to identify the key material parameters responsible for degrading the desired properties at interfaces from those of ideal materials. Accurate theoretical predictions, which are essential for optimizing performance, require models for electrical transport on spatial scales spanning many orders of magnitude (interfaces, grains, wires) and computer algorithms capable of computation on multiple length scales for complex geometries.

Theory of Strongly Correlated Materials

Strong interactions between electrons in materials, which can lead to significant quantitative changes (e.g., masses of the mobile charge carriers becoming hundreds of times larger than those of free electrons), can also lead to qualitatively new states of matter, such as intricate forms of charge and spin order. It is known that such strong interactions underlie many unconventional superconductors — most spectacularly, the cuprate high-temperature superconductors. Moreover, they play a key role in other important classes of materials of interest to DOE, such as transuranic elements and compounds. Understanding the effects of strong electron-electron interactions is of great fundamental interest, and new paradigms must be developed to understand the “strong correlation” regime. In the cuprates, this strong interaction between electrons is enmeshed in materials that are structurally complex and that display coupling of the electrons to the atomic vibrations as well. The observed strong dependence of the superconducting properties of cuprates on crystal structure and on defects is yet to be understood.

Building on the cuprates (which are, by far, the highest- T_c materials known to date) is clearly an important avenue to pursue, but to do so will require a much better understanding of the underlying interactions: the electron-electron interactions leading to collective (correlated) behavior in charge and spin motion, and the electron-lattice interactions mediated by atomic vibrations, which appear to be in the strong (polaronic) limit. To interpret the increasingly rich set of data that are being obtained through many experimental efforts, models that incorporate the differences between various members of the cuprate family, which are reflected in their differing superconducting properties, must also be pursued.

Efforts to form quantitative theories describing the various interactions among the electrons are becoming increasingly intricate and challenging, and supercomputing efforts will, in many cases, be essential in order to make detailed predictions from these theories. Extensions of these theories to simultaneously include more than one pairing mechanism may be necessary to adequately account for the variety of experimental data. As more interactions are included in strongly correlated models, a means to constrain these models on the basis of available data and to eventually make them material-specific will be needed. Improved theoretical and computational methods for determining the ground states and other properties of these models are also necessary. The incorporation of strong electron-electron interactions into the description of the electronic behavior of specific correlated materials is a true frontier area in physics that is being breached at exactly this moment, and the anticipated “theoretical synthesis” provides a real promise for a more general and unified theory of strongly correlated electron materials within the next decade.

Exotic Pairing Mechanisms and Ground States

The superconducting state of the cuprates lowers the symmetry of the electronic system. This is one of the clearest examples of “unconventional” superconductivity. There are strong indications that (1) the normal state of cuprates is also highly unconventional when compared with the normal state of more typical metals; (2) although phonons may play an important role, superconductivity is primarily driven by another mechanism; and (3) the above is true not only for cuprates but also for several classes of exotic

superconductors, such as organic metals, heavy fermion materials (made out of rare earth or actinide elements), and most likely some quasi-two-dimensional oxides of Ru and Co. One popular conjecture is that superconductivity in all these materials is due to magnetic (or other electronic) interactions that typically have substantially larger energy scales than do phonons.

While the examples of MgB_2 and Li show that the variety in the world of conventional superconductors is far from being exhausted, it is also evident that there is enormous potential for discovering new materials in the unconventional superconductor world. One can use an analogy of a search party that travels along only one line, as opposed to another that explores a whole area, except that in our case, the extended search is in a multidimensional space with many tuning parameters.

However, until we have comprehensive theories of unconventional superconductivity that explain not only the cuprates but also the other materials mentioned above, we will not be able to fully understand why one unconventional superconductor has a T_c well above 100 K (cuprates), while another has a maximum T_c below 2 K (ruthenates). Moreover, for a long time, the large class of heavy fermion superconductors included only materials that were superconducting at temperatures below 2 to 3 K, but the recently discovered heavy fermion material PuCoGa_5 has a T_c of nearly 20 K — an order-of-magnitude jump. What is responsible for this large increase? Can it be that another material will gain another order of magnitude, with a T_c of 200 K? Theory should help in this quest.

POTENTIAL IMPACT

The scientific challenge of carrying out a search for and designing new superconductors, and of forging a comprehensive theory of superconductivity, is enormous, but the potential for a tremendous breakthrough is at hand. A full microscopic understanding of high-temperature cuprate superconductors and other unconventional superconductors will enhance our ability to search for new superconducting materials, as well as provide us with the knowledge of which “knobs” to “tune” to enhance the material properties of existing superconductors. For example, understanding the role of two-dimensionality in high-temperature cuprate superconductivity will allow us to design isotropic high- T_c materials, which will be highly advantageous for applications.

IDENTIFY THE ESSENTIAL INTERACTIONS THAT GIVE RISE TO HIGH- T_c SUPERCONDUCTIVITY

Understanding the underlying principles of high-temperature superconductivity is a problem whose complexity far exceeds that encountered with previous application-relevant electronic materials. Now, however, an exponential growth in the power and speed of advanced experimental techniques can allow us to attack this problem in a completely new way. A coordinated application of these techniques to achieve a complete determination of all the relevant electronic and magnetic susceptibilities (the “genome”) of this form of electronic matter is needed. The outcome should reveal the special electronic ingredients that create a superconducting state at such high temperatures, and thereby enable rational, strategic searches for new high-temperature superconductors with desired properties.

EXECUTIVE SUMMARY

Despite their tremendous diversity, all superconductors share one common aspect: The origin of the zero resistance state is ultimately connected to the pairing of electrons. Therefore, unraveling the nature of the forces binding electrons in pairs represents the ultimate challenge of research on novel high-temperature superconductors. But the experimental complexity of the task has proved to be daunting — especially in the context of the small scale upon which electronic materials research has traditionally been carried out. We propose to address this challenge with a nationwide concerted effort *to develop and apply the full power of novel experimental techniques and facilities* that only recently have begun to come online. The objective will be a complete determination of the superconductor’s universal and intrinsic electronic and magnetic susceptibilities: the “genome” of high-temperature superconductivity. Complete knowledge of this electronic matter “genome” can reveal the special electronic ingredients that generate the high-temperature superconducting state. It will also enable strategic searches for new high-temperature superconductors with desired properties.

The focus of this priority research direction (PRD) is the coordinated application of the whole arsenal of novel experimental tools to well-characterized samples of different, unconventional superconductor classes. However, equally important for progress in this formidable task is developing theoretical approaches and frameworks well suited to analyze the high data volumes of experimental information derived from complimentary experimental probes. Recent literature gives several impressive examples of major advances in the superconductivity field produced by a consistent theoretical description of data inferred from numerous experiments. Specifically, an analysis based on the interaction of the electrons with collective excitations appears to provide a consistent description of ARPES, tunneling, optical, and neutron data. With new probes and techniques yielding the “genome” of the electronic matter, applied in combination with comprehensive theoretical analysis, one can anticipate a long-awaited breakthrough in the understanding of novel superconductors.

RESEARCH DIRECTIONS

Coordinating Application of Powerful New Techniques to Find Electron Pair Binding Force

The unprecedented progress of experimental techniques and facilities over the last 10 years provides, for the first time, an opportunity to probe electronic matter at the necessary precision and scope levels. The scientific challenges of novel and high- T_c superconductors have actually been a key driving force for the development and refinement of all these novel experimental capabilities. The net result is that the arsenal

of techniques accessible to condensed matter physicists can now enable analysis of the response functions of materials — the dielectric function and magnetic susceptibility — with a previously unattainable level of sophistication and detail. Examples of entirely novel research capabilities of great power that are now coming online include angle-resolved photoemission spectroscopy (ARPES) with remarkable energy and momentum resolutions; spectroscopic imaging-scanning tunneling microscopy (SI-STM), enabling mapping of the atomic-scale energy-resolved density of electronic states over extraordinarily large areas; infrared and optical spectroscopies, facilitating probes of electronic excitations and charge dynamics both in frequency and time domains; inelastic X-ray scattering, enabling chemically specific determination of electronic states within atoms and their spatial distributions; and high-intensity neutron scattering (NS), allowing precision measurements of both magnetic ground states and the complete spectrum of magnetic excitations. These exciting new experimental techniques, if applied to their full capabilities and in combination, could finally uncover the physical processes responsible for the formation of superconducting pairs in unconventional superconductors.

Development of new experimental techniques plays a critical role in addressing profound problems, such as the pair-formation mechanism in high-temperature superconductors. Although recent progress has been unprecedented, several key developments are still required. These include (1) time of flight, pump-probe, and spin-polarized capabilities in ARPES to allow detailed studies of electron dynamics and nonequilibrium effects, as well as improvements in inverse photoemission to extend ARPES to unoccupied-state studies; (2) scanning tunneling microscopy to map out spatial variations in superconducting phase coherence to detect nonequilibrium effects at picosecond frequencies in combination with optical techniques, to image simultaneously with ARPES, and to search for spin-polarized electronic states; (3) X-ray capabilities with enhanced sensitivity for simultaneous probing of diffraction and coherent scattering.

Mapping Electronic/Magnetic Susceptibilities and Atomic-Scale Structures

A coordinated combination of NS, ARPES, SI-STM, and inelastic X-ray scattering is needed to determine the structural, doping, temperature, and energy dependences of the electronic susceptibilities in real and momentum space. Similarly, a combination of spin-polarized ARPES, spin-polarized SI-STM, and NS will be applied to determine the structural, doping, temperature, and energy dependences of the magnetic structure and susceptibilities in real and momentum space. This will be a huge undertaking, rivaling astrophysical “sky surveys” or biological “genome mapping” in data volume and complexity. It can only be achieved with coordination, cooperation, and sustained support.

Of particular interest are effects whereby the electronic translational invariance is spontaneously lost — formation of electronic crystals, electronic liquid crystals, or pair crystals/glasses. SI-STM, inelastic X-ray scattering, and nanometer-resolution ARPES can play a critically important role in characterizing these effects. A combination of these tools should be developed and applied to determine the electronic and magnetic phenomena in disordered, glassy, or periodic environments at the atomic scale. If achieved, this thrust will open the way for critically important studies of other materials with spontaneous electronic organization.

Understanding the Dynamical Processes

The last critical element required is to understand completely the dynamical processes occurring in interactions between electrons and with their environment in such complex electronic matter as high-temperature superconductors. Here, broadband optical techniques are dominant, but if they can be adapted for high frequencies, SI-STM and ARPES can play a supportive role in characterizing these effects. A

combination of these tools should be developed and applied to characterize the dynamical processes and interactions between the electrons themselves and with the superconducting electron pairs and crystalline lattice.

SCIENTIFIC CHALLENGES

The key challenge is to identify and completely characterize the electronic and magnetic susceptibilities critically important for exotic superconductivity — all at the atomic scale. Practical challenges include the development and integration of the different experimental techniques with each other and new theoretical tools.

POTENTIAL IMPACT

The impact could be very great indeed. This PRD requires a new general paradigm for solving problems of complex electronic matter. It may lead to identifying the mechanism of high-temperature superconductivity and other complex electronic matter states. The energy security benefit will be to use our knowledge of the electronic matter “genome” to design and create new electronic materials.

ADVANCE THE SCIENCE OF VORTEX MATTER

The aspect of a superconductor that is most relevant for technological applications — its capability to carry loss-free currents — is determined entirely by the behavior of superconducting vortices. Recent advances in nanotechnology and in computational as well as experimental techniques provide new opportunities to design and evaluate novel vortex phases and conductor structures that extend the limits of vortex pinning and current-carrying capability to higher temperatures and magnetic fields. To develop high-performance superconductors for power applications, we must understand and unravel the complex interactions between vortex matter and nanopinning sites and develop a microscopic theory elucidating the mechanisms underlying the onset of dissipation.

EXECUTIVE SUMMARY

The phase diagram of vortices in superconductors shows remarkable variety in its ordered, glassy, liquid, and dynamic states, a collection that derives largely from three competing effects. The repulsive vortex-vortex interaction favors ordered vortex lattices of various symmetries, the attractive vortex–pinning site interaction induces disordered glassy vortex states, and thermal fluctuations melt the vortex lattice into a liquid state. In addition, depending on the material’s anisotropy (often brought about by a layered stacking structure), the vortex properties of the superconductor may be strongly influenced by the orientation of the applied magnetic field. In cases of extreme anisotropy, such as in $\text{Bi}_2\text{Sr}_2\text{CuC}_2\text{O}_x$, coreless Josephson vortices can squeeze in between the superconducting layers and interact with two-dimensional (2-D) pancake vortices that are confined to the CuO_2 layers. The rich set of phenomena observed in the vortex system (e.g., melting, elastic and plastic deformations, and pinning by dislocations) are well known in ordinary matter — thus, the nomenclature *vortex matter*.

The complexity of vortex matter, while daunting at some level, affords new opportunities to extend the performance limits of superconductors to higher temperatures and fields. For example, commensurate correlated nanoscale pinning arrays can be exploited to induce effective pinning in the vortex liquid state, a vast section of the phase diagram that so far has been considered unable to carry loss-free current. A microscopic theory of pinning and dissipation is still lacking. However, such a theory, combined with powerful new multiscale modeling approaches to the vortex-pinning landscape, will guide us toward optimized vortex-pinning schemes and improved performance.

Complex dynamic, dissipative vortex states can arise when vortices are driven by large forces induced by a strong applied current. Although the mechanisms underlying the onset of dissipation are unresolved, they are, nonetheless, of critical importance in the operation of superconductors, particularly under alternating current (ac) conditions. Three-dimensional modeling of the nonlinear superconductor response to high current applications will elucidate the criteria for the occurrence of dissipative vortex motion and its dependence on the underlying pinning structure.

This priority research direction (PRD) combines theoretical and powerful new numerical approaches with advanced experimental probes of vortex matter. Scanning probes, imaging, and microscopy techniques with unprecedented resolution allow, for the first time, the direct visualization and probing of the states of vortex matter, thereby validating the modeling and, ultimately, yielding a detailed and predictive understanding of vortex matter.

The approaches outlined here will be applicable beyond high- T_c superconductors. The recently discovered two-band superconducting state in MgB_2 suggests the existence of a new microscopic vortex state consisting of two concentric cores. Because this new material, with a T_c of 40 K, holds the potential to

displace current, widely used low-temperature superconductors, such as NbTi, it is important to understand its vortex phases and pinning mechanism. Furthermore, the physics of dynamic and static vortex states is at the forefront of nonlinear many-body systems. New discoveries in the science of phase transitions, self-organization, and threshold behavior are certain to emerge.

RESEARCH DIRECTIONS

Pinning of Vortex Matter

Pinning the Vortex Liquid. Extending the operation of superconductors to higher temperatures, and particularly to higher fields, will require conquering the vortex liquid state. In the vortex liquid, viscous flow of vortices past pinning sites and past each other renders traditional pinning schemes largely ineffective. However, the recent observation of effective pinning in the liquid state by columnar defects aligned with the vortex direction suggests new strategies.

Periodic/quasi-periodic arrays of linear correlated defects, such as columnar defects or dislocations, will effectively immobilize every vortex over its entire length. The periodic arrangement also minimizes the mutual potential energy of vortices, since this is the natural state of the unperturbed vortex system, resulting in very stable, highly pinned vortex structures. Self-assembly or templated growth (see Figure 30) will offer low-cost approaches to fabricating nanostructured samples with patterned periods that are small enough (<100 nm) to allow efficient operation in magnetic fields that are high enough for applications in cables or transformers. Techniques for introducing a small splay between the columnar defects could be developed to frustrate the vortices, thereby inducing geometrical entanglement: A vortex residing in between columnar defects can move only if it cuts through other vortices. 2-D correlated defects (grain or twin boundaries, interfaces in multilayered structures) that are aligned with the current flow and the field direction also block liquid vortex flow effectively.

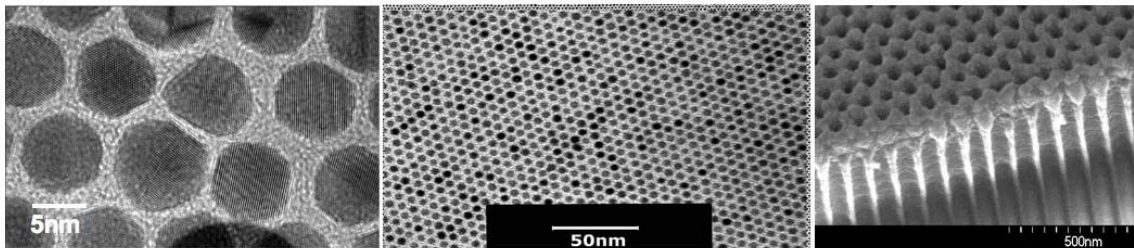

Figure 30 Transmission electron microscopy (TEM) image of self-assembled gold (left panel) and cobalt (center panel) nanoparticles. Scanning electron microscopy (SEM) image of niobium film deposited on an ordered, self-assembled nanoporous membrane of anodic aluminum oxide (AAO) (right panel). The small sizes of these particles and holes are comparable with the vortex length scales and constitute a self-organized pinning landscape by design. (Images courtesy of X.-M. Lin and U. Welp, Argonne National Laboratory.)

The magnetic interaction between vortices and the magnetic domain structure in superconducting/ferromagnetic multilayers offers a complementary approach for achieving efficient pinning in the vortex liquid state (Figure 31). For example, it might be possible to fabricate magnetic layers, such as manganites or ruthenates, which allow for lattice-matched growth of multilayers with high- T_c superconductors. Before this can be accomplished, we need to have fine-scale labyrinth domains

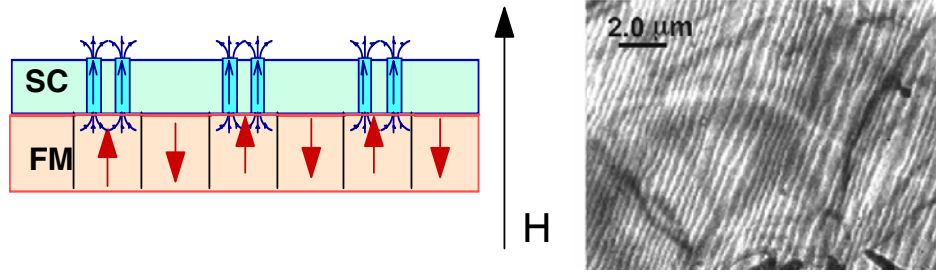

Figure 31 Left panel: Scheme for blocking the vortex flow in a superconducting (SC)/ferromagnetic (FM) bilayer due to the magnetic interaction with the domain structure, shown here for applied fields exceeding the saturation magnetization.

Right panel: Lorentz microscopy image of domains in an epitaxial film of strontium ruthenium oxide (SrRuO_3) obtained at $T = 100$ K. These magnetic stripe domains could be exploited to “dam” vortex flow [after L. Klein et al., *Phys. Rev. Lett.* **84**, 6090 (2000)].

with high coercive fields. The attractive interaction of vortices with the up-domains and the repulsive interaction with down-domains could induce large pinning energies, which can extend to high temperatures.

Pinning the Vortex Glass. The vortex glass phase encompasses essentially all high-performance superconductors. The vortex system in the glass phase can be modeled as an ensemble of elastic string-like objects, which adjusts itself to the pinning landscape at the expense of increased interaction energy. Although the pinning sites enhance the critical current, an excess of dislocations can stimulate the so-called plastic creep motion, causing detrimental dissipation. In this process, the vortex glass approaches energetically more favorable configurations: It ages. Two far-reaching consequences arise from this glassy dynamics: the electromagnetic properties of the glass change with time, and the glassy system displays a memory effect. The properties of the vortex glass at a given temperature and magnetic field depend on the history (i.e., on the process by which the given state was reached). These phenomena become especially important when the superconductor operates under ac conditions. Hence, there is an urgent need for a comprehensive theory to enable (1) the optimum design of pinning sites and (2) the strongest suppression of creep to support stationary behavior of the vortex glass state.

Modeling Multiscale Pinning Landscapes. Real-world materials, such as the present first-generation (1G) and second-generation (2G) superconductors, are fabricated through a complex synthesis route that introduces structural defects at many length scales. These defects can range in size from nanometers to micrometers and come in a wide variety of shapes. Of particular interest is the issue of modeling this complex family of defects in a way that allows us to optimize the critical current $J_c(T, H)$ through such parameters as the spacing and size of the defects. Computational power has advanced at a phenomenal rate, and problems that just a few years ago would have been untenable can now be broached. An example is the recent large-scale simulation of the terahertz emission from strongly driven Josephson vortices in bismuth strontium calcium copper oxide (BSCCO). Here, we need simulations of the three-dimensional (3-D), nonlocal, nonlinear electrodynamics of the vortex system in the presence of pinning structures of increasing complexity, ultimately yielding a detailed and predictive understanding of vortex matter under direct-current (dc) and ac drives.

Dynamics of Nonequilibrium Vortex Matter

Dynamic Vortex Phase Diagram. Vortex matter driven by strong currents exhibits a multitude of dynamic effects, which contribute to power losses in superconductors, especially in alternating electromagnetic fields. Here, the challenge is to understand the complex magnetic field-temperature-current (H - T - J) phase diagrams, which, in addition to the thermodynamic phases, contain distinct nonequilibrium states. An example is the recent theoretical prediction and experimental observation of dynamic melting, in which plastic flow (or fluidlike incoherent motion) of vortices transforms with increasing driving current into a coherent motion of an ordered vortex lattice. This has opened up the new, largely unexplored field of nonequilibrium vortex matter, which addresses the physics of strongly interacting vortex lines driven by currents through pinning defect nanostructures. Understanding nonlinear vortex motion in highly inhomogeneous superconductors remains a major challenge. We need a comprehensive theory, which could describe the percolating motion of vortices and the related problem of aging and memory effects in vortex glassy states under high driving currents. We also need accurate 3-D simulations of the onset of depinning and the onset of plastic vortex motion as a function of the vortex-pinning landscape.

Mechanisms of Dissipation. As mentioned earlier, a moving vortex generates an electric field, which registers as a drop in voltage across a superconductor, thereby negating its “zero-resistance” property. The relationship between the microscopic mechanisms that lead to this dissipation and the registered voltage is not well understood. In particular, we need to address the physics of the complex energy transfer associated with the electrons in the “normal” core of a moving vortex, which is subject to strong thermal fluctuations and pinning interactions. We need to understand the effects of the d-wave symmetry of the order parameter in the cuprates and of the two-gap order parameter in MgB_2 on vortex friction. Josephson vortices are “coreless” and therefore not subject to the above mechanisms of dissipation. In fact, they can move at high speeds without significant friction. Recent studies that manipulate 2-D pancake vortices to influence or pin the driven coreless Josephson vortices in highly layered superconductors demonstrate that the *viscosity* of the latter can be enhanced, pointing to new methods for arresting the vortex liquid motion.

This study is also critical to a related area of research that deals with the effects of Joule heating and nonequilibrium electron states on the electrodynamics of superconductors. For example, a positive feedback between vortex motion and Joule heating can cause large thermomagnetic instabilities, which manifest themselves as dendritic flux avalanches (Figure 32) and can destabilize the current-carrying capability of a superconductor (i.e., cause a quench). The speed and size distributions of the dendrites are determined by the interplay of nonlocal flux diffusion and local heat diffusion. The higher the critical current density is, the steeper are the flux gradients, and the larger is the risk for thermomagnetic breakdown. There is a strong need to develop a quantitative theory and simulation that can describe both the magnetic and thermal stability for realistic conductor geometries and suggest stable architectures. This work is particularly important with regard to superconducting fault current limiters, which can trip due to a quench on the first overcurrent excursion.

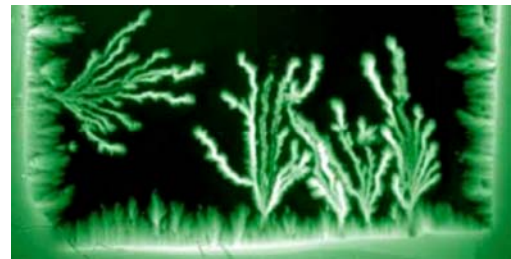

Figure 32 Magneto-optical image of magnetic flux avalanches penetrating into a MgB_2 film at 5 K (Image courtesy of T.H. Johansen, University of Oslo).

Advanced Probes of Vortex Matter

This PRD combines theoretical and powerful new numerical approaches with advanced experimental probes of vortex matter. Scanning probes, imaging, and microscopy techniques with unprecedented resolution enable the direct visualization and probing of the states of vortex matter. The techniques of scanning tunneling microscopy (STM) and scanning tunneling spectroscopy (STS) have already been applied with great success to the study of vortex matter in BSCCO and yttrium barium copper oxide (YBCO). Their further development will be indispensable for mapping the vortex system at high densities and for unraveling the dissipative mechanisms occurring in the vortex core. Scanning Hall probe microscopy approaches a resolution of 100 nm in high background fields, and further improvements in resolution appear likely. Magneto-optical imaging has been very successful for mapping macroscopic flux distribution. Advanced implementations using pump-probe or stroboscopic techniques will allow for the study of fast vortex phenomena, such as thermomagnetic breakdown. Thermal imaging, either in the form of scanning thermocouples or optical fluorescence, holds great potential for directly locating areas of excess dissipation and needs to be advanced. Of particular interest would be the development of imaging techniques for the surface electric field, since this quantity is directly related to the distribution of vortex velocity that lies at the heart of all dissipative processes. Other promising approaches include scanning potentiometry, scanning single-electron devices, or electro-optical imaging. The advanced experimental techniques will validate the results of modeling and theoretical analysis and, ultimately, help to establish a detailed and predictive understanding of vortex matter.

SCIENTIFIC CHALLENGES

The scientific challenges in vortex matter research lie in two areas. One relates to basic science, exemplified by the discovery of new static and dynamic vortex phases and the theoretical challenges of developing a microscopic theory of vortex pinning. The other relates to use-inspired research and promotes new methodologies to increase critical currents at all temperatures and magnetic fields. One basic research challenge is the development of a microscopic theory for vortex dissipation that takes into account the new superconducting properties associated with d-wave and triplet pairing states and multiband superconducting states. Obtaining key parameters related to the transformation of the quasi-particle electrons in the moving vortex core into the various superconducting pairing states will be a challenge in experimental characterization. Meeting this challenge will require sophisticated scanning probes at the nanoscale with resolution approaching the superconducting coherence length. Another challenge is to identify new theoretical and experimental methodologies to arrest vortex creep and simulate and fabricate new pinning geometries, which would generate higher critical currents in the vortex glassy and liquid states. One of the greatest use-inspired research challenges is to overcome the barrier presented by the vortex liquid state, which prevents the utilization of high-temperature superconductors at their upper temperature limit. Furthermore, to understand the fundamental limits of critical currents and fields of superconductors and new effects caused by vortex creep and related memory and aging effects, we must develop new theoretical and large-scale computational methods to calculate the dynamics of strongly interacting fluctuating vortex lines in a multiscale pinning potential. An immediate challenge will be to develop new (1) theoretical tools to help us understand the largely unexplored physics of nonequilibrium vortex matter, which has the remarkable potential to generate terahertz radiation, and (2) characterization tools that can probe dynamic vortex phenomena at high speeds and at the nanoscale.

POTENTIAL IMPACT

This program will generate new breakthroughs in our understanding of the fundamental limits of the critical current and magnetic field in superconductors. It could potentially result in new high-performance superconducting materials, in which optimum pinning defect structures could be “designed” into commercial conductors by using recent advances in nanotechnology and self-assembly. It is very probable that new ultra-high-temperature superconductors will come from a highly layered structured material with high anisotropy and with a large portion of the superconductors’ vortex phase diagram relinquished to the liquid phase. Basic research to surmount the barriers to vortex liquid pinning by using cleverly designed directional pinning sites to counter or nullify the anisotropy could hold the key to the commercial implementation of future superconductors.

Furthermore, advances in understanding the dynamics of vortex matter can result in new sources of terahertz electromagnetic radiation and reduce losses in superconductors in alternating electromagnetic fields. Recent advances in the area of vortex dynamics have introduced fundamental new concepts going well beyond vortex physics, contributing to our understanding of physical behaviors in such seemingly unrelated areas as the physics of cracks and dislocations in solids, dynamics of domains in magnets, and physics of localized electrons in metals. Future discoveries in the field of vortex matter motivated by the important technological quest of energy transmission and delivery will play a primary role in the materials physics of the 21st century.

CROSS-CUTTING RESEARCH DIRECTIONS

New Tools to Integrate Synthesis, Characterization, and Theory	137
Enabling Materials for Superconductor Utilization	141

NEW TOOLS TO INTEGRATE SYNTHESIS, CHARACTERIZATION, AND THEORY

Given both the complexity of the problem and the need for more rapid progress, closer integration among synthesis, characterization, and theory is needed for superconductivity research. Many of the techniques and methods to accomplish this remain to be invented or discovered. Here, we highlight a few specific opportunities that have emerged as a means of motivating further progress.

EXECUTIVE SUMMARY

Magnesium diboride is a common chemical and one of several hundred known boride compounds. Although it was understood for many years that this type of compound might be the basis of a high-temperature superconductor, the robust superconductivity of magnesium diboride was only discovered in 2000 by chance. The problem is that methods for efficiently discovering and characterizing superconductivity in broad classes of materials did not exist. Computational studies of magnesium diboride have shown that theory could have predicted its favorable properties, had someone looked. Efficient computational screens and methods to apply them to search thousands of potential materials for better superconductors remain to be developed. Such techniques favor discoveries of revolutionary new materials, rather than the incremental improvements that are likely from minor chemical variations in existing materials.

Similarly, scanning tunneling spectroscopy (STS) and angle-resolved photoemission spectroscopy (ARPES) have played a key role in unraveling the electronic structure of high-temperature superconductors. STS measures the local electron density with atomic resolution, while ARPES provides momentum-resolved information on electron states. Both techniques are known to be extremely surface-sensitive. Thus, we need to further develop and improve techniques for determining the crystalline structure of the surface layer. Another major limitation of STS and ARPES studies is that samples must be easily cleavable. This could be overcome by integrating ARPES and STM with in-situ thin-film synthesis using an ultra-high vacuum deposition technique, such as molecular beam epitaxy (MBE). This approach would extend the applicability of ARPES and STM to virtually any material that can be grown by MBE, including artificial heterostructures. Such an integrated capability would propel the science of high-temperature superconductors and other correlated electron materials to an unprecedented level.

RESEARCH DIRECTIONS

Computational Libraries of Potential Superconductors

The best superconductors may occur in new, presently unknown structures. Advances in theoretical methods now enable prediction of stability and metastability of as-yet-unsynthesized phases and calculation of these notional materials' properties. New synthesis techniques, both nanoscale and bulk, provide many opportunities for synthesizing notional compounds. However, to exploit these capabilities and discover better superconductors, we need efficient ways of constructing materials libraries that are not presently known, but which could be synthesized if favorable properties are expected.

Identifying Simplified Criteria for Screening Materials and Implementing Them into Computational Algorithms

Full calculation of the key parameters for conventional superconductors is a laborious, computationally challenging task even for relatively simple materials. It would have been possible to discover magnesium diboride computationally, but only if someone had looked specifically at this compound. However, there was no way to identify this compound as the one to investigate out of hundreds of alternatives, nor was there a way to efficiently search this class of materials. Over time, improved algorithms and improvements in computer technology will enable more extensive exploration using full calculations of materials properties. Development of screens for potential superconductors will greatly facilitate this search, because it will allow identification of the most likely candidates to be studied with slower, but more reliable approaches. These screens will be most effective if they are fully materials-specific, include the interactions responsible for superconductivity, and require little or no experimental input.

Integrating Synthesis and Surface-Sensitive Characterization Techniques

The inability of STS and ARPES to probe a large variety of samples has presented a hurdle in our quest to unravel the mechanism of high-temperature superconductivity and other fundamental issues in condensed matter physics, such as the nature of electronic excitations, the role of competing orders and inhomogeneity, etc. Since both techniques have a very shallow probing depth (about 1 nanometer), it is critically important that the sample surface is completely clean. The main functioning method today is to create a fresh surface by cleaving the crystal inside an ultra-high-vacuum chamber. The drawback is that this trick works well only for the few materials that are easily cleavable.

Molecular beam epitaxy (MBE) is a precise and versatile synthesis technique capable of providing atomically smooth and perfect films of various complex oxides. However, to perform measurements on MBE-grown films today, they must be removed from the chamber. This leads to contamination, which makes them unsuitable for study by surface-sensitive techniques. An opportunity exists to seamlessly integrate atomic-layer MBE synthesis with state-of-the-art STS and ARPES characterization within a single, multi-functional, ultra-high-vacuum system to synthesize the compound(s) of interest with the desired doping level and surface termination. We could then proceed without interruption to full-scale characterization of electronic states using ARPES and STS. Such a facility (or facilities) would dramatically expand the range of materials and surfaces accessible to ARPES and STS, and hence propel the science of high-temperature superconductors and other correlated electron materials to an unprecedented level.

Developing Reliable and Fast Methods to Determine the Surface Structure

Many modern materials are very anisotropic and often inhomogeneous, with properties highly dependent on the probed direction and changing at the local (nanoscale) level. Much of the current thinking about the physics of high-temperature superconductors relies heavily on studies by STS and ARPES. STS measures the local electronic density with atomic resolution, so it is well-suited for the study of the inhomogeneity of electronic properties. ARPES provides momentum-resolved information on the electronic states and their interactions. Both techniques are known to be extremely surface-sensitive — they only probe a few atomic layers closest to the sample surface. Thus, our current understanding of this phenomenon hinges on the assumption that the surface layer has structural, electronic, vibration, and transport properties identical to those in the bulk. Since the cohesion energy in ionic crystals is long-range, we know that this cannot be true — the surface layer *must* be different. The critical question is: *by*

how much? To answer this, we need to determine the real structure of the surface layer, and either measure or deduce the corresponding superconducting and other physical properties.

Several techniques have emerged in recent years that hold great promise for surface structural characterization. The first is surface X-ray crystallography, including coherent Bragg rod analysis (COBRA). The technique involves precise measurement of X-ray intensity as a function of angle and distance from the sample surface, followed by extensive iterative data processing to yield atomic structures of thin epitaxial films with sub-Ångstrom resolution. Another technique with great potential is low-energy ion-scattering spectroscopy. In the low-energy range (from 1 to 10 keV), ions scattered from the surface are sensitive only to the top few atomic layers. Great precision can be achieved by pulsing the ion beam and measuring the time necessary for the ions to travel from the point of collision to the detector(s) — the so-called “time-of-flight” technique. Information about the surface comes from the fact that this travel time depends primarily on the nature of the atoms or ions present on the surface and also on the nature of the interactions. It has been shown experimentally that the spectra depend strongly on the angle of incidence and/or detection — a small rotation by merely one degree can result in a dramatic change in the recorded spectrum. This indicates a great sensitivity to the type and arrangement of the atoms on the surface. Angle-resolved ion scattering spectroscopy can thus provide real-space information about the surface crystal structure, potentially with unprecedented resolution (a small fraction of an Ångstrom).

SCIENTIFIC CHALLENGES

Exploiting the synergy between material specific theory, computation, and novel synthesis techniques is a new paradigm for materials discovery. Application of such approaches in various fields may lead to revolutionary discoveries.

Both research directions expounded above present significant technical challenges. It will be necessary to design, build, refine, improve, and automate complex new instruments, some for the first time ever. The design has to ensure seamless integration of different modules, which has not been accomplished so far either.

POTENTIAL IMPACT

Discovery of entirely new materials and classes of high-performance superconductors will enable new applications by providing a suite of engineering materials with a mix of properties, such as cost, environmental sensitivity, performance, and manufacturability. In-situ ARPES and STM on MBE-grown thin films would provide a new platform to extend the applicability of these powerful techniques to virtually any material that can be grown by MBE. One could even access phases that do not exist in the bulk (e.g., high-pressure phases stabilized by compressive epitaxial strain, or ultra-thin films and heterostructures with thicknesses comparable to the probing depth). Knowledge of the surface structure of films and substrates would be highly valuable for improving the techniques of growing high-quality thin films of superconductors and other complex materials. It would be even more valuable once we endeavor to systematically modify and engineer them on an atomic-layer level.

ENABLING MATERIALS FOR SUPERCONDUCTOR UTILIZATION

Current superconductors offer the potential to provide five times greater power capacity in secure underground cable systems, as well as energy-efficient generation and use. Fully integrated power systems, in which superconductors are the key technology, will utilize numerous other low-temperature materials. To achieve the maximum potential, breakthroughs are needed not only in terms of better superconductors but also with respect to related magnetic, dielectric, and insulating materials. The full implementation of this vision will require advances beyond those achievable with present-day conductors, low-temperature materials, and cryogenic systems.

EXECUTIVE SUMMARY

Electric-power systems require numerous other materials in addition to the conductor itself. For example, insulators, dielectrics, magnet materials, semiconductors, and thermal insulation are all required in a fully operational system. System complexity, and hence system cost, would be reduced if these supporting materials and materials technologies would also operate in the same cryogenic environment as the superconducting material. Complexity would be decreased because the number of input and output electrical connections through the vacuum enclosures and thermal insulation would be greatly reduced. The refrigeration efficiency would be increased, since the efficiency of large refrigerators is greater than that of smaller refrigerators. And finally, many of these materials would perform better and be more reliable at cryogenic temperatures. Thus, there is a driving need to investigate the integration of nonsuperconducting materials and components into superconducting or cryogenic system concepts.

Cryogenic operation is a large factor in the effective implementation of superconducting technology. As the operating temperature increases, the costs go down, as both refrigeration loads and system complexity are reduced. The discovery of high-temperature superconductors (HTSs) in 1986 reduced the refrigeration costs by a factor of 10 (relative to low-temperature superconductors [LTSs]) and enabled implementation of superconducting technology in the energy sector for the first time.

Superconducting cables must still be cooled to temperatures well below that of any place on Earth, implying the need for complex cryogenic cable systems (refrigerators, insulation, vacuum enclosures, etc.). The cost of a superconducting system (after acquisition of a right-of-way) will depend on the cost of materials, the manufacturing costs of the components, the costs of system installation, the operating costs, and the cost of repair and maintenance. An increase in operating temperature reduces costs in a number of ways; for example, the refrigerator will be more efficient, less costly to manufacture, use less power in operation, and be more reliable. Similarly, a cryogenic system operating at temperatures of approximately 120 K (the temperature of liquefied natural gas [LNG]) will be simpler, cheaper to build, and more compact.

The operating temperature of superconducting power systems can be increased in two ways: (1) by improving the performance of existing superconductors (with 77 K, the temperature of liquid nitrogen, being a likely upper limit) or (2) through the discovery of new superconductors with a higher critical transition temperature (T_c). (Reaching an operating temperature of 120 K is a realistic goal, because the critical temperatures of several known superconductors already exceed 120 K.) Both of these approaches are discussed extensively elsewhere in this report.

There are, however, other important ways of enhancing system performance and reducing total system (acquisition and operating) costs. Improvements in the efficiency of refrigerators would have a major impact, as would increased refrigeration reliability. At present, commercially available refrigerators

operate far below their theoretical efficiency (known as the Carnot efficiency). Similarly, materials advances drive performance and cost improvements.

RESEARCH DIRECTIONS

As discussed elsewhere in this report, improved superconducting wire that will provide increased performance at higher operating temperatures is clearly needed. Cost reductions and reliability improvements would result. A major advance would occur if a superconductor could be found that allowed higher operational temperatures than those being proposed for the present first-generation and second-generation HTSs. Research in both of these areas should be pursued.

Low-temperature Insulators

Cryogenic insulation with high breakdown voltages is needed to isolate superconducting components that are at different voltages. These insulators should be mechanically strong and have high thermal conductivity, and their thermal expansion coefficients should be similar to those of other joining components. On the other hand, electrical wire insulation should have high thermal conductivity, because losses in the conductors often have to be transferred through the electrical insulation. Nonsuperconducting metals are used as input/output leads to the cryogenic environment; thus, they require high electrical conductivity and minimal thermal conductivity. Fundamental physics provides a limiting relation between electrical and thermal conductivity. This limit could possibly be altered in atomically designed multicomponent systems. Research in metals and insulators for cryogenic operation will result in improvements in currently used components.

Magnets and Dielectrics

All utility transformers have a magnetic core to reduce the size and weight of the transformer. Yet no magnetic core exists for cryogenic temperatures. Thus, superconducting transformers either use air cores or thermally isolate the magnetic core from the cryogenic environment in vacuum. Such designs are complex, costly, and more failure-prone than a design that would incorporate the magnetic core in the same cryogenic environment as the superconducting wires. Research on the development of cryogenic magnetic materials useful for transformer cores (or inductor cores) would greatly help the insertion of superconducting transformers into the utility grid.

Capacitors are integral parts of electrical systems. They are used as filters (along with inductors) to improve power quality and as short-term energy storage to regulate power levels. Capacitors require high-dielectric materials to store charge and are optimized to work at room temperature. As is the case for transformers and inductors, there are no commercially available capacitors that are designed for cryogenic temperatures. The dielectric constant of many materials increases by orders of magnitude at cryogenic temperature, suggesting a tenfold increase in capacitance is possible for properly optimized cryogenic capacitors. Research on dielectric materials and their integration into capacitors offers entirely new concepts for energy management in the grid.

Control Systems

Control of electric power is often accomplished with large and inefficient power electronics composed of inductors, capacitors, and semiconducting power switches. These switches (e.g., metal-oxide semiconductor field-effect transistors [MOSFETs], insulated-gate bipolar transistors [IGBTs], and gate-turnoff [GTO] thyristors) are also designed to operate at room temperature, and most will not work at cryogenic temperatures. A limited number of devices do function at cryogenic temperatures; however, even these “unoptimized” semiconducting switches have improved properties (i.e., less “on-state” resistance and faster switching speeds) at the lower temperatures. Semiconducting power switches designed for cryogenic operation would improve the quality of the power and the efficiency of the overall power control system and allow better integration with attached HTS systems. Research on new materials and new device structures for cryogenic semiconducting power switches, together with cryogenic capacitors and inductors, would open up a new design paradigm wherein one could consider placing entire substations underground for efficient, secure, and environmentally friendly power transmission.

Maximize Refrigeration Efficiency

Refrigerators operating at temperatures of 77 K require 10 to 15 times more input power than their cooling power. Thermodynamic laws would predict an ideal power ratio of only about three at this temperature; thus, there is much room for refrigerator efficiency improvement. Different refrigeration cycles, different refrigeration materials (gas or liquids), and the study of dynamical instabilities in fluid flow may all help improve our understanding of refrigeration inefficiencies. Also to be considered as part of this research topic are advances in precision manufacturing techniques that would reduce cost, improve reliability, and enable mass production. An example of a prototype HTS power cable with some of its vacuum-cryogenic components is shown in Figure 33.

SCIENTIFIC CHALLENGES

Although some superconducting materials with T_c 's higher than 120 K do exist, none are suitable as conductors in electric-power applications. The operating temperature is typically less than three-fourths of the transition temperature; hence, a superconducting material with a transition temperature of at least 160 K is desirable. This 160 K superconductor would need to have high critical current capacity at high magnetic fields in all directions at 120 K. It would have to be structured in a manner that would produce low alternating-current electrical losses. Achieving this goal would require a composite conductor composed of small-diameter, multifilamentary, twisted or transposed superconducting strands.

The need for refrigeration systems that approach the theoretical Carnot efficiency, are reliable, and can be built in volume at low cost is a major unsolved problem associated with all cryogenic systems. Dielectric materials that operate at cryogenic temperatures with large dielectric constants and high breakdown

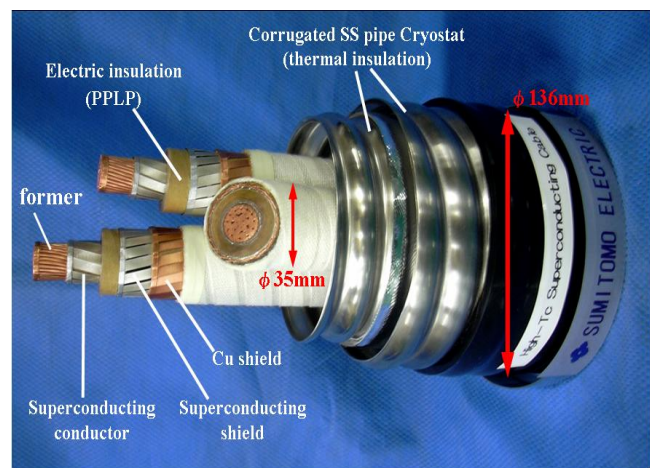

Figure 33 A prototype three-phase HTS power cable for installation in underground conduits. Several material components provide different functions in the integrated system. Here, multiple superconducting tapes make up the electrical conductor and magnetic shield. Stabilizing, insulating, and vacuum-cryogenic materials must be compatible with the mechanical, electrical, and thermal stresses arising from installation and operation.

voltages must be found. Magnetic materials that operate at cryogenic temperatures with high permeability and low losses must also be found. Finally, semiconducting power devices that operate at cryogenic temperatures with low loss and high breakdown voltage must be developed.

POTENTIAL IMPACT

Reaching the goals set forth above will result in the supporting materials and technologies needed to provide our electric-power system with unprecedented security and capacity that can be accessed in an environmentally friendly manner by our society in the future. In particular, our power system would be revolutionized by an integrated cryogenic system that would include superconductors, transformers, capacitors, and semiconducting switches designed to transport electricity and LNG in an underground superconducting transmission line. Such a system would be environmentally benign, economically compelling, and secure against environmental or terrorist intrusions.

CONCLUSION

CONCLUSION

We depend on the electricity grid to supply clean, abundant power for a growing urban population and its personal, industrial, and commercial needs. The demand for electricity is expected to grow by 50% in the United States and 100% globally by 2030. Urban and suburban grid capacity is limited by saturated overhead access lines and underground cables, and by the cost and permitting restrictions associated with new power corridor construction. Reliability is compromised by voltage fluctuations outside acceptable windows, intentional rolling blackouts and brownouts during peak demand, and local power failures that cause economic loss and can cascade to regional proportions. The North American blackout of 2003 and subsequent blackouts in London, Scandinavia, and Italy demonstrate the ever-increasing risk of widespread outages caused by cascading failures.

As described in this report, we have made enormous progress in understanding high-temperature superconductivity and applying it to grid technology. In summary, superconductivity has the potential to

- Increase the capacity of the electricity grid without new construction,
- Restore the grid's reliability through smart, self-healing control and regulation devices, and
- Significantly improve the grid's efficiency through the use of resistanceless wires in underground cables and power control machinery.

The past two decades have seen the successive development of two generations of commercially viable superconducting wire. The second generation represents a radical departure in materials, design, and fabrication, with the potential for significantly higher performance compared to the first generation. Second-generation (2G) wire based on yttrium barium copper oxide ($\text{YBa}_2\text{Cu}_3\text{O}_7$) carries five to six times more current than copper wire of the same cross-section, providing ample capacity to accommodate growing power demands by replacement instead of new construction. Second-generation wire transports electricity on the grid at 77 K cooled by inexpensive liquid nitrogen, and it operates in the magnetic field environment of transformers, fault current limiters, and rotating machinery at ~ 50 K cooled by mechanical cryocoolers. In contrast, first-generation (1G) wire must be cooled to ~ 30 K to operate in magnetic fields. While these accomplishments in developing superconducting wire demonstrate the promise of high-performance superconducting technology for the power grid, significant gaps in performance, cost, and materials must be overcome to achieve widespread market penetration in grid applications.

If these gaps can be overcome, superconducting technology offers significant benefits for grid operators and for consumers. For example, superconducting fault current limiters can detect overload currents automatically by switching abruptly into their normal states, and reset automatically when the overloads are cleared. This fast, self-healing action exceeds the capability of conventional fault current limiters, protects the grid from damage, and enhances the grid's stability in high-power-density urban areas. Superconducting transformers, generators, and motors can cut volume, weight, and electrical losses in half, and they are far more tolerant of voltage, frequency, and reactive power fluctuations than their conventional counterparts. In heavily populated areas, superconducting power control devices like the dynamic synchronous condenser can provide instantaneous control of reactive power to maintain maximum power flow and stability in compact, economical packages that are suitable for urban use.

CHALLENGES

Although the promise of applying superconducting technology to the task of transforming the power grid is within reach, significant challenges remain in the areas of performance, cost, and materials.

Performance — The performance of 2G wire in zero magnetic fields enables the transport of current at 77 K, but its performance drops significantly in fields as low as 0.1 T (needed for transformers and fault current limiters), and even more at 3–5 T (needed for motors and generators). *The current-carrying capability of 2G wire must be increased by a factor of 5–10 in magnetic fields of 0.1 T–5 T to make it effective in superconducting control devices and rotating machinery at 77 K.*

Cost — The cost of 2G superconducting wire is currently too high — by a factor of 10–100 — to compete effectively with copper. Much of the cost resides in its complex multilayered architecture, requiring the sequential deposition of up to seven layers on a flexible metal substrate, maintaining the crystallographic alignment of the substrate throughout the stack of layers. *The materials architecture of superconducting wire must be simplified to reduce manufacturing costs without sacrificing transition temperature or current-carrying ability.*

Materials — The copper oxide materials in existing superconducting wire operate effectively only at temperatures of 77 K or below, and their ultimate pinning strength and current-carrying ability is limited by their intrinsic anisotropy, approximately 7 for yttrium barium copper oxide (YBCO) and 200 or more for bismuth strontium calcium copper oxide (BSCCO). We need new superconducting materials with higher transition temperatures to reduce refrigeration costs, and lower intrinsic anisotropies to boost performance. Experience with copper oxides at transition temperatures up to 164 K in mercury barium calcium copper oxide ($\text{HgBa}_2\text{Ca}_2\text{Cu}_3\text{O}_8$) under pressure suggests that there is no fundamental limit to the transition temperature. Likewise, intrinsic anisotropy can, in principle, be reduced to its ultimate limit to form a fully isotropic superconductor. *Future generations of superconducting wire will require breakthrough superconducting materials offering higher transition temperatures (up to room temperature) and lower intrinsic anisotropies (down to 1).*

These challenges capture the breakthroughs needed for superconducting technology to transform the power grid to dramatically higher levels of capacity, reliability, and efficiency. These technological challenges are mirror images of a set of scientific challenges that probe the very heart of superconductivity: the materials factors that favor high superconducting transition temperatures, the vortex-pinning strategies that produce the ultimate current-carrying ability, and the pairing mechanisms and correlated electron states that produce high-temperature superconductivity.

Since the beginning of superconductivity research, new superconductors have been discovered by serendipity rather than by rational insight. Despite our best intellectual efforts, we cannot anticipate if a given material will be superconducting, nor can we define the materials aspects favorable to superconductivity. Yet the pace of discovering superconducting materials has never been quicker, often in materials that defy conventional wisdom like magnesium diboride (MgB_2), actinide-based heavy fermions, and the copper oxides themselves. Recent experience suggests that the complex interaction of many degrees of freedom, the competition of opposing ordered states, or the proximity to a quantum critical point may be factors. *We must establish the “family tree” of superconductivity by pursuing the search for new superconductors, sorting them into materials families, and analyzing the relationships among families and the trends within them.*

The macroscopic electrodynamic behavior of superconductors derives from the microscopic behavior of many vortices interacting with many pinning sites. Despite the fundamental importance of such macroscopic properties as the lossless current-carrying ability, the resistance to currents above the lossless limit, and the response to alternating current (ac) currents and magnetic fields, we cannot derive them

from a given microscopic landscape of pinning sites. We do not know, for example, why we never achieve more than 10–20% of the theoretical maximum current-carrying ability, even though estimates based on the pinning of individual vortices by individual pinning sites predict nearly the full theoretical maximum. *We must understand the emergence of the macroscopic properties of vortex matter from the microscopic interactions of an array of vortices with a realistic landscape of diverse, interacting pinning sites, emphasizing the lossless current-carrying ability and the resistance for currents above the lossless limit in the solid and liquid phases of vortex matter.*

The ultimate challenge of superconductivity is finding the mechanisms of pairing and correlated electron states of high-temperature superconductivity. The overwhelming success of Bardeen, Cooper, and Schrieffer (BCS) theory for conventional superconductors is an inspiring beacon for this challenge, although the d-wave pairing symmetry and much-higher transition temperatures of the copper oxides indicate that their pairing mechanism may be very different. A telling clue in high-temperature superconductors is that even the *normal* state is highly correlated, showing self-organized charge stripes, pseudogaps, and, at lower doping levels, an antiferromagnetic insulator transition. The fact that these highly correlated normal states exist at high temperature makes plausible a highly correlated superconducting state cut from the same cloth. The complexity of the normal state, with interacting charge, spin, orbital, and structural degrees of freedom, may play a key role. *We must unravel the mystery of high-temperature superconductivity to find the pairing mechanism, the highly correlated superconducting state, and the superconducting state's relationship to the highly correlated normal states.*

These intertwined grand challenges — transforming the power grid with superconducting technology to dramatically higher capacity, reliability, and efficiency; tracing the family tree of superconductivity among the diversity of superconducting materials; understanding the emergence of macroscopic electrodynamic properties of superconductors from microscopic vortex-pin site interactions; and discovering the pairing mechanisms and highly correlated states of high-temperature superconductivity — define a single mission that is simultaneously at the frontier of basic science and the frontier of practical application. It is dual-use research in the purest sense, following the spirit of Pasteur and squarely in the middle of Pasteur's Quadrant.

These grand challenges have broad impact beyond the science and technology of superconductivity. The groundbreaking physical insights of superconductivity methodologies have always set the trends for the physics of other condensed matter systems, and, in the case of BCS theory, even for particle, nuclear, and astrophysics. The highly correlated superconducting states of the copper oxides are intimately related to their equally interesting and mysterious highly correlated normal states. A breakthrough in the copper oxides' superconductivity will immediately open new doors to understanding normal-state electronic behavior in the complex oxides and perhaps other physical systems. Correlation is one of the most universal concepts in science, applying not only to electrons but also to superfluids, nuclear matter, and Bose-Einstein condensates. The techniques for handling quantum correlation of electrons and Cooper pairs in high-temperature superconductors will provide insights for these systems as well.

OUTLOOK

The priority research directions and cross-cutting research directions identified by the workshop provide the vision to address the grand challenges of superconductivity science and technology. These research directions take full advantage of (1) the recent advances in nanoscience and nanotechnology to fabricate and characterize nanostructured materials; (2) the high-intensity sources of neutrons, X-rays, and electrons at DOE's user facilities to probe the highly correlated superconducting and normal states with ever smaller spatial, temporal, and energy resolution; and (3) the advances in computational power and

techniques implemented on Beowulf clusters and supercomputers to simulate the highly correlated electron states leading to high-temperature superconductivity.

The workshop participants completed their work with a strong sense of optimism spanning the basic and applied research communities. Although the challenges are daunting, the progress of the last two decades puts the knowledge and tools for overcoming them in our hands. The development of two generations of practical superconductors based on very different paradigms demonstrates that competitive performance is at hand or within reach. The profusion of new classes of superconducting materials promises new generations of practical superconductors, and our increasing experimental and theoretical penetration of their highly correlated normal and superconducting states promises breakthroughs revealing the elusive origins of high-temperature superconductivity. The rich static and dynamic behavior of vortices in solid, liquid, and glassy states and our control of artificial pinning landscapes through emerging nanofabrication techniques promise order-of-magnitude improvements in current-carrying performance. Implementing the priority and cross-cutting research directions identified by the workshop has a high potential for producing the breakthroughs in superconductivity science and technology that are needed to transform the power grid to dramatically higher capacity, reliability, and efficiency and to unravel the mysteries of high-temperature superconductivity.

APPENDIX 1: CURRENT STATE OF RESEARCH

CURRENT STATE OF RESEARCH

**On Opportunities for Basic Research in Superconductivity
Focused on Science and Energy Relevant Technologies.**

prepared for the

Workshop on Basic Research Needs for Superconductivity

**May 8-11, 2006
Washington, DC**

**Chair: John Sarrao (Los Alamos National Lab)
Co-Chair: Wai-Kwong Kwok (Argonne National Lab)**

**Sponsored by the U.S. Department of Energy,
Office of Basic Energy Sciences**

TABLE OF CONTENTS

INTRODUCTION AND OVERVIEW	157
SUPERCONDUCTING MATERIALS.....	160
Search for and Discovery of New Superconductors	160
Main Achievements Over the Past 20 Years.....	161
Key Outstanding Issues	161
Advanced Synthesis of Known Superconductors	163
Key Accomplishments.....	163
Some Outstanding Materials-Related Issues.....	165
Synthesis and Study of Nano-Structured Superconductors.....	165
Further Reading: Superconducting Materials	169
PHENOMENOLOGY OF HIGH TEMPERATURE & EXOTIC SUPERCONDUCTIVITY.....	171
Key Physical Phenomena of Copper Oxide Superconductivity	171
Advances in Techniques for High Temperature Superconductivity	176
Strategic Challenges in Copper Oxide Superconductivity.....	178
Further Reading: Superconductivity Phenomena.....	181
VORTEX PHENOMENA.....	183
Equilibrium Vortex Properties.....	183
Vortex Pinning.....	183
Vortex Pinning and Dynamics in Superconducting Wires.....	184
Low Temperature Superconductors.....	185
High Temperature Superconductors	186
Further Reading: Vortex Phenomena.....	191
THEORY.....	193
Introduction.....	193
Mechanisms and Other Fundamental Issues.....	193
Principal Directions of the Theory.....	195
Computational Superconductivity and Search for New Materials.....	197
Theory of Superconducting Interface Phenomena.....	201
Theory for Applications.....	204
Examples of Theoretical Accomplishments.....	209
Further Reading: Theory.....	210
ENERGY RELATED APPLICATIONS FOR SUPERCONDUCTORS.....	212
Background.....	212
The Need for Superconducting Technology	212
The Grid as a Focus	212
Other Applications of HTS Conductors.....	214
Classical Nb-Based Superconductors	215
1 st Generation (1G), Bi-Based HTS Conductors.....	215
2 nd Generation (2G), YBCO-Based Conductors	216
Other Novel Wire: MgB ₂	219
AC Loss Issues	219
The Cost Issue.....	220
Further Reading: Applications.....	220

Introduction And Overview

This document has been designed to provide a common context for all workshop participants and to set the scientific tone for the DOE-Basic Energy Sciences Workshop on “Basic Research Needs for Superconductivity.” It surveys recent results and developments in the field of superconductivity and is intended to enable a common starting point for participants, organized, as the workshop itself is, around aspects of materials, phenomena, theory, and applications research.

The discovery of high-temperature superconductivity in copper-oxide materials with transition temperatures exceeding that of liquid nitrogen has reinvigorated research focused on energy applications for superconductivity. While these materials remain a focus of much research both for potential applications and due to outstanding fundamental science challenges, there are a number of other classes of superconductors, from organic materials to heavy fermions and MgB_2 that are scientifically mysterious and have potential for future energy relevant applications.

Given its significant role in the overall energy infrastructure of the United States, the electric grid looms large in the set of applications to be considered. The normal metal conductors used today operate with transmission losses that are between 7 and 10%. Given the magnitude of the power being moved in the US, there exists significant opportunities for energy impact with improvements in transmission efficiency. In addition, the electric grid operates in many places near or at capacity. The high demand on the system contributes to both short and extended power outages, with estimated costs to the economy of \$1 – 10 B per year. An even greater concern is the fact that the electric power flow is expected to double by 2010. A superconducting grid would enhance significantly the current-carrying capacity, reduce transmission losses and dramatically improve the overall reliability of the system. Further, superconductor-based fault-current limiters and related systems designed to improve stability and reduce load fluctuations can benefit today’s non-superconducting grid. The development of such systems is currently a focused effort in the Superconductivity Program within the Office of Electricity Delivery and Energy Reliability.

In addition to grid applications, which generally require superconducting materials to perform in self magnetic fields, there are a number of applications, generally involving rotating components, in which higher field performance is essential. These include motors, generators, and transformers, and a number of demonstration projects and commercial units are in progress or have been completed. Advantages include greater energy efficiency, as well as reduced component weight and footprint. On the other hand, these applications raise additional performance challenges including ac losses in the presence of an external field. While important progress has been made in recent years, significant scientific grand challenges and technical hurdles remain for the full exploitation of superconductivity for energy utilization.

Scientifically, superconductivity has remained a central theme within materials research since its initial observation in 1911 by Kamerlingh Onnes. While it is only one of a number of many-body ground states that can result in solids, it has attracted significant attention as a frontier of fundamental science (and an associated series of Nobel Prizes). In fact, the community is presently celebrating two significant anniversaries in the history of superconductivity: the 50th anniversary of the first comprehensive theory of superconductivity, published in 1957 by Bardeen, Cooper, and Schrieffer, and the 20th anniversary of the discovery, by Bednorz and Mueller in 1986, of high-temperature superconductivity in copper-oxide materials. In addition to the Nobel Prizes won by these individuals, Nobel Prizes have also been won by Abrikosov and Ginzburg for fundamental understanding of vortex phenomena in superconductors, and by Giaever and Josephson for experimental and theoretical work related to tunneling phenomena.

Within this historical context and as part of a broader initiative within Basic Energy Sciences to identify grand challenge science opportunities for energy security as described in “Basic Research Needs to Assure a Secure Energy Future,” BES has charged the workshop participants to identify basic research needs and opportunities in all areas of superconductivity with a focus on new, emerging and scientifically challenging areas that have the potential to have significant impact in science and energy-relevant technologies.

Superconductivity research emphasizes close coupling among materials synthesis, physical characterization, and functional utilization along a continuum that extends from fundamental science to real-world applications. Theory

plays an important role in understanding, and in a limited but growing number of instances, predicting new discoveries. Thus, while the present factual document is organized around materials, phenomena, theory, and applications, broader themes should naturally cross-cut and emerge from these sections. Indeed, a principal focus of the workshop for which this factual document was prepared is to identify a small number of priority research directions that span these approaches and have the greatest likelihood of driving qualitative and revolutionary breakthroughs for the understanding and utilization of superconductivity.

New Materials. The recent discovery of novel systems -- such as the two band superconductor MgB_2 with T_c as high as 40K, doped fullerenes A_xC_{60} with $T_c=33\text{K}$, and exotic superconductivity in the heavy fermion superconductor PuCoGa_5 with $T_c=18\text{K}$, an order of magnitude higher transition temperature than previously reported -- suggests the ubiquity of superconductivity, once considered a rare phenomenon. Moreover, the discovery of high T_c superconductivity in the cuprates has demonstrated that superconductivity is no longer a low temperature phenomenon and present theories suggest no barriers to higher transition temperatures. These discoveries serve as springboards for the search for new superconducting materials. The search for new materials is bolstered by new synthesis and doping techniques which enable crystal growth in extreme environments, rapid combinatorial search methods, and precision atomic-layer engineering. Sophisticated doping techniques, such as field-effect doping which induces no chemical disorder, open new horizons for tunable doping in a single sample. A strong synergy between materials synthesis, characterization, theory, and computation is needed to achieve success in the quest for new ultra-high-temperature superconductors.

Phenomena. The search for novel phenomena in high temperature and exotic superconductors, along with progress in understanding these materials, has led to the development of powerful new experimental tools such as scanning tunneling probes and sophisticated electron, neutron and x-ray scattering techniques with unprecedented spatial and spectral resolution and that enhance the capabilities of traditional techniques. The new tools have been used to elucidate the existence of a cluster spin glass state, ordered stripe phases, a pseudogap regime, d-wave superconductivity, two band superconductivity and the first measurement of the Fulde Ferrell Larkin Ovchinnikov state. More recently, they have been employed to investigate the excitation spectrum for spin density waves in the cuprates. Further, common features are being observed across classes of unconventional superconductors such as the high T_c cuprates, heavy fermion, and strontium ruthenate superconductors. These features include a strong dependence of T_c on physical/lattice structure as well as electronic structure. The unraveling of the mystery behind the mechanism for high T_c superconductivity will open new research directions, leading toward new compounds with higher transition temperatures, less anisotropy and higher critical currents. Understanding these properties is critical to developing superconducting materials that can be practically applied to help meet the energy needs of the United States.

Vortex phenomena play a fundamental role in almost all practical applications of superconductivity since vortex dynamics and its related effects control the electrodynamic response and behavior of all superconductors. The deceptively simple electrostatics of a single vortex belies the dynamical complexity of an ensemble of vortices responding to their mutual repulsive interactions and simultaneous attractive interactions to an array of pinning sites. Describing the emergent behavior of such complex systems is a fundamental challenge touching many areas of science. The analogs between the rich static and dynamic behavior of vortices in superconductors and of atoms in ordinary solids and liquids justify the name *vortex matter*. The importance of the vortex state concept was recognized by the 2003 Nobel Prize awarded to Alexei Abrikosov for his theoretical prediction of the existence of superconducting vortices.

The problem of vortex pinning and optimization of electromagnetic and transport properties of superconductors by incorporation of artificial structural defects has become one of the central issues in the fundamental and technological studies of high temperature superconductors. One of the key advances spurred by the study of vortex phenomena in high T_c superconductors was the determination of the static and dynamic vortex phase diagram and the development of the theory of vortex creep dynamics. Fundamental research in this area has led to the establishment of the vortex glass and Bose glass theories, with the latter providing the basis for understanding that correlated disorder is an extremely effective vortex pinning mechanism; the theory of dynamic phase transition in moving vortex structures which forms the foundation for the design of a self-healing electric grid; the theory of the dynamic melting of the vortex lattice; and the experimental observation of a vortex liquid state. One of the grand challenges for the future is to devise new vortex pinning mechanisms to arrest vortex flow in the liquid state. Liquid

state vortex flow is ubiquitous in high temperature superconductors and constitutes a significant barrier to technological applications at high temperatures and magnetic fields.

Theory. The understanding of new superconducting pairing mechanisms could guide the choice of materials to synthesize and may eventually lead to the capability to predict whether new bulk materials and nano-architected structures will be superconducting. Recent advances in first principles calculations assisted by enhanced computational power and the generalization of density functional theory can accurately predict the electronic structure of complex materials. Coupled to a proposed pairing mechanism, numerical models are beginning to produce predictive capabilities for superconducting transition temperature, which could find materials-specific implementation. These prediction methods may be applied to new superconductors based on MgB_2 , doped diamond superconductors and doped fullerenes. These new advances are the first steps towards the *rational design* of new superconductors and provide new directions for the grand challenge search for room temperature superconductors.

Applications. A strong impetus for fundamental research in superconductivity is the need for an efficient, reliable and secure electrification of American society. The demand for electricity in the United States grows at a rate of about 2.3%/year and the fraction of total energy consumed in the form of electricity is expected to rise from 40% to 70% in the near future. The physical properties of superconductors could facilitate revolutionary advances in power transmission using the existing copper conduits of the electric grid. These advances may include automated self-healing and extremely high current carrying capacity. Moreover, complementary superconducting power equipment such as fault current limiters, transformers and synchronous condensers will be smaller, lighter and operate with higher capacity than conventional equipment. First generation (1G) high temperature superconducting cables are already used in “real-world” demonstrations and 1G-based dynamic synchronous condensers are commercially available. Second generation (2G) cables are currently being developed and are poised to vastly supersede the performance of 1G. These projects are a mere beginning. Basic research combining materials synthesis, the study of superconducting properties and vortex phenomena, and theory will provide the seed for evolutionary and revolutionary advances leading to superconductors with higher transition temperatures, higher critical currents, and isotropic pinning behavior that will be necessary for the creation of a future reliable, efficient and secure Superconducting Grid.

Superconducting Materials

SEARCH FOR AND DISCOVERY OF NEW SUPERCONDUCTORS

Searching for new superconductors always plays a crucial role in the study of superconductivity. It is a high risk / high payoff endeavor. The effort has led to the discovery of new compounds, the enhancement of the superconducting transition temperature, the improvement of superconducting performance, the discovery of new physics and the development of new tools for the study of solids. Its impacts range from introducing new paradigms into condensed matter science to revealing novel applications with rich technological potentials. The discovery of superconductors in unexpected classes of compounds has been a defining influence in the development of condensed matter physics. The challenge to understand them leads to new theories, the development of new tools for experimentation and eventually a deeper understanding of nature. The unique properties that are often discovered may directly open ways to new or improved technology, or may remain in the “scientific bank” until a societal need arises.

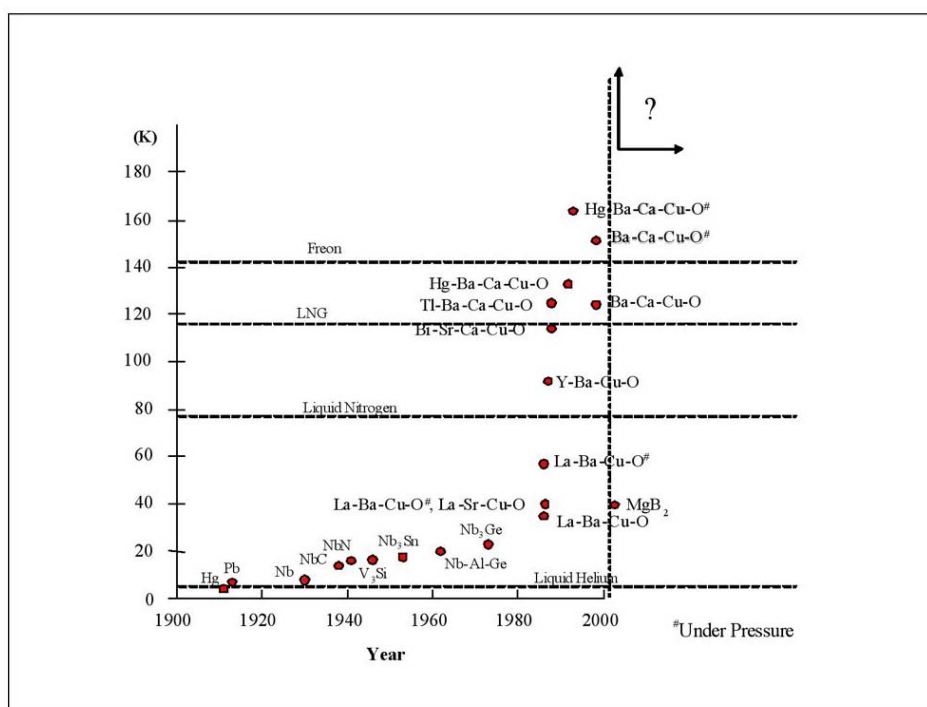

Figure 1 The history chart of discovery of new superconductors with ever increasing transition temperatures

Over the past 20 years the search for, and discovery of, new superconductors has allowed us to go from thinking of superconductivity as a fairly rare and uniform (BCS, s-symmetry) relatively low temperature state to the realization that superconductivity, in its multitude of manifestations, is the ground state for many different kinds of compounds, even ones that appear to be barely metallic. Although superconductors are still rare, the larger number of mechanisms now recognized or suspected as giving rise to superconductivity has opened up many more avenues in the search for new superconducting materials than were previously thought to be viable.

This is a vital scientific realization that is directly the result of the discovery of novel compounds.

MAIN ACHIEVEMENTS OVER THE PAST 20 YEARS

Discovery of high-temperature superconductivity (HTS) in cuprates

The above statements are well illustrated by the enormous influence that the discovery of superconductivity in cuprates has had on science and technology. This discovery has marked the decade, not only because of many perceived applications, but also because it has triggered a revolutionary break with well-established conceptual foundations of condensed matter physics. The struggle to rebuild the new theoretical framework is still ongoing and intense, and “understanding the mechanism of HTS” is considered by many as the most important open problem in condensed matter physics.

This discovery has clarified several facts. Superconductivity is no longer perceived as a low-temperature-only phenomenon. A room temperature superconductor does not seem impossible anymore. Next, it appears that the highest- T_c materials are all complex compounds, with low dimensional structure; moreover, each of these contains at least one very light element in the formula unit. While it is tempting to invoke a high density of states and high energy of phonons, in the absence of a broadly accepted theory of HTS, it is unclear which of these factors are really crucial.

Discovery of other new and ‘exotic’ superconductors

Novel superconductors have been found throughout the periodic table from the light elements, boron and lithium, to the heavy trans-uranium series, and in many complex compounds such as organic charge transfer salts. Some of these have notably high transition temperatures, such as MgB_2 with $T_c = 40$ K, alkali-intercalated ‘bucky-balls’ (fullerenes) A_xC_{60} with $T_c = 33$ K, and $\text{RNi}_2\text{B}_2\text{C}$ and $\text{YPd}_2\text{B}_2\text{C}$ that combine local moment magnetism with T_c values as high as 23 K. Some are interesting because they are ‘exotic’, such as the heavy fermion superconductors CeMIn_5 ($M=\text{Co}, \text{Rh}, \text{Ir}$), CePt_3Si , and PuCoGa_5 with $T_c = 18$ K, the ruthenates (Sr_2RuO_4) where the order parameter may have p-wave symmetry, the ruthenocuprates where antiferromagnetic order (co-) exists independently of HTS even though they are only few a angstroms apart, and MgB_2 where we have an example of two-band superconductivity. Superconducting boron-doped diamond may be interesting for electronics. $\text{Na}_x\text{CoO}_2 \cdot \text{H}_2\text{O}$ is another very interesting new correlated-material system. One should also mention detection of relatively high T_c superconductivity in a number of elements under very high pressure. Some elements stand out with T_c exceeding 10 K in the Mega-bar pressure range, such as Li and S with $T_c = 17$ K, Ca with $T_c = 15$ K and B with $T_c = 11$ K. Very recently, the discovery of superconductivity in CaC_6 at $T_c = 11.5$ K more than doubled the transition temperature of graphite intercalation compounds.

KEY OUTSTANDING ISSUES

Search for new superconductors

The search for new superconducting materials with higher values of the key parameters (T_c , H_{c2} , j_c , etc.) remains at the top of the list of important tasks. It seems almost certain that discoveries will continue to be made. Indeed, the grand challenge in superconducting materials is the synthesis of an isotropic room-temperature superconductor (RTS) with high critical current - or else the proof that this is impossible. Such a discovery would have a disruptive effect on energy technology, enabling a host of new applications in the efficient production, storage and use of electrical energy.

The most direct approach for finding new superconductors is to identify and execute a series of systematic searches of phase space to find new compounds. These can be done by identifying promising regions of composition space and rapidly examining as many compounds as possible in this space. Such studies are what yielded the explosion of inter-metallic superconductors in the 1950’s and 1960’s. These need to be resumed in ternary or higher space, focusing on likely regions, e.g. ternaries with light elements, etc.

In addition, it is important to continue our search for materials with exotic forms of superconductivity. As an example, the search for compounds with high-magnetic-field stabilized superconductivity, the Jaccarino-Peter effect, could potentially yield new, ultra high field superconducting states.

New synthesis and doping techniques

Synthesis at extreme conditions. Empirically, superconductivity frequently appears close to structural phase transitions; indeed, many superconductors are metastable and need to be synthesized under a very high pressure (several-to-many GPa) and at high temperature. In addition, many of the elements that need to be incorporated into potential new compounds are extremely volatile, reactive, or refractory (e.g. Li, B, C, Mg, P, S, Se, Te) and require special environments for successful utilization. Such techniques should be developed further, including the growth of sizeable single crystals, in particular for inelastic neutron scattering experiments where material quantity is critical.

Combinatorial search. Systematic combinatorial search for new (superconducting) compounds can be based on thin-film deposition techniques. One ('digital') approach is to use masking and prepare small homogeneous areas that vary in a systematic and digital fashion over the substrate. In another, continuous phase spread method, multiple sources or targets are used to achieve variable film composition across the substrate. To reap full benefits of such 1D or 2D combinatorial libraries, one also needs high-throughput characterization methods such as Magnetic Field Modulated Spectroscopy (MFMS) which is a fast and very sensitive technique for detecting superconductivity. Combinatorial techniques for both synthesis and characterization should be further improved, and applied on a much larger scale in search for new classes of superconductors with desirable properties.

Atomic-layer engineering, artificial superlattices. Rapid advances in thin film deposition techniques are now opening opportunities in materials science and chemistry to go well beyond the limitations of bulk phase equilibria. It is possible to extend phase boundaries, to obtain new metastable phases and microstructures, to create multilayered structures, to apply large in-plane strain, and to obtain sharp interfaces across differently ordered systems. Single crystal multilayer structures bring together materials with different properties at interfaces not disturbed by contamination or disorder. New electronic structures can result based on mixing of states and transfer of charge and spin at such interfaces. Varying the composition and structure of the adjacent insulators offers rich possibilities for tuning superconductivity in these interfacial structures using epitaxial strain and stabilization, as well as atomic-layer engineering of interfaces.

Field-effect doping and photo-doping. Chemical doping, necessary to achieve metallic and superconducting state in cuprates and some other compound superconductors, has the drawback of concurrently inducing disorder. The induced disorder not only hampers understanding by making it difficult to differentiate between intrinsic and extrinsic properties, but can actually degrade the superconducting properties. Furthermore, the chemical doping level is in most cases not tunable; one needs a separate sample for each composition. Field effect doping and photo-doping, where charge carriers are introduced by application of a strong electric field or intense illumination, avoid these drawbacks. In both cases, the doping level will be continuously tunable in a single sample without any induced chemical disorder. This promising methodology has high potential in the search for novel superconductors among complex compounds.



Figure 2 High Pressure Anvil Furnace; max. $p = 60$ kbar; max. $T = 1000$ °C. [R. Cava, Princeton U.]

ADVANCED SYNTHESIS OF KNOWN SUPERCONDUCTORS

Often, the most interesting new superconductors are difficult to make, either due to complexity of the chemistry or structure, or due to more mundane materials issues. Progress in experimental study and theoretical understanding has been hampered by materials problems ranging from large unit cells to volatility and reactivity of constituent elements causing problems in stoichiometry. Better material and sample quality is the critical prerequisite for rigorous experimental work where the physics is in the “clean limit” – free of any spurious, extrinsic effects. Furthermore, improvement in physical properties – for example T_c , H_{c2} , J_c , etc. - brings known superconductors closer to possible applications.

For many classes of superconductors the ready access to clean, adequately sized, single crystalline samples has been vital to ongoing research. The rapid growth and availability of crystals of the RNi_2B_2C series has made it one of the best characterized series of magnetic superconductors currently known. In a similar manner, single crystals of $CeCoIn_5$ (and its relatives) have enabled the extensive study of high temperature, heavy fermion superconductivity. In the absence of large single crystals, high quality polycrystalline samples are valuable for characterizing superconducting properties and often define the basic features like the transition temperature, condensation energy, grain boundary connectivity, and the electron and phonon density of states. The considerably more challenging synthesis of single crystals makes high quality polycrystalline samples the first target for exploring the behavior of newly discovered superconductors.

Perhaps the most dramatic example of the need for well controlled single crystals is that of the HTS cuprates. Here, materials improvement, both in terms of crystal quality and crystal size, has been essential in moving the field forward. For example, large single crystals are needed for inelastic neutron scattering studies, a powerful magnetic bulk probe. Until recently these large crystals were only available for one or two (out of many dozens) known HTS phases.

One of the focal issues for many new superconductors has been the role of electronic vs. chemical and structural inhomogeneity. Experimentally, one needs to separate materials-specific properties from those that are intrinsic to the superconducting ground state. To this end, the ability to characterize and control the structure-stoichiometry-property relationships in these compounds is vital. Examples below show some milestone improvements in synthesis and sample preparation techniques, in sample quality, and in physical properties of known superconductors.

KEY ACCOMPLISHMENTS

Single crystal growth. Single crystal samples of novel compounds are grown in a wide variety of manners. Solution growth and growth by vapor transport have been exceptionally powerful tools for all classes of superconductors ranging from intermetallics and oxides to organics. These techniques have continued to evolve over the past decades, expanding the range of solvents, transport agents, and temperatures they can handle. For many classes of superconductors the state-of-the-art samples are produced via these methods. One advantage of solution growth is its versatility and speed which often produces samples of exquisite purity and mosaic. However, it does not routinely produce the cubic centimeter sized samples needed for inelastic neutron scattering experiments.

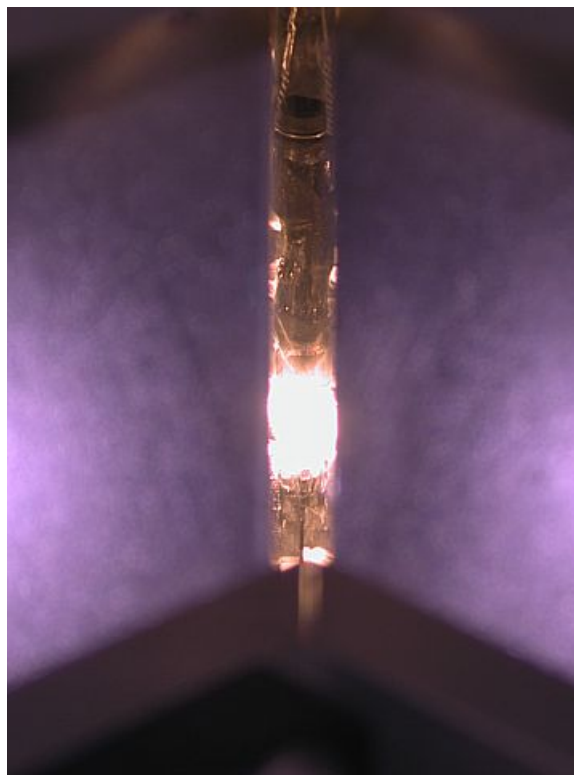

Figure 3 Growth of a large single crystal for x-ray and neutron scattering experiments by the traveling-solvent floating-zone method. [M. Greven, Stanford U.]

The floating-zone synthesis can often address the issue of sample size, but only for a limited set of known materials. This technique has emerged in recent years as the principal technique for growth of single crystals of some superconducting oxides. It has enabled improved $\text{La}_{2-x}\text{Sr}_x\text{CuO}_4$ crystal growth, and this allowed detailed studies, including neutron scattering, of the subtle structural and magnetic properties all the way from the undoped to the highly overdoped regime. In $\text{TlBa}_2\text{Ca}_2\text{Cu}_3\text{O}_{9+\delta}$ and $\text{Bi}_2\text{Sr}_2\text{CaCu}_2\text{O}_8$, it was possible to minimize the effects of disorder and raise T_c . Very recent advances in growing sizable crystals of the Hg-based compounds - the materials with the highest T_c values - have resulted in crystals that are orders of magnitude larger than the previous record. It should be noted though that even for high T_c compounds, meticulous use of solution growth has produced high-purity single crystals of YBCO and other phases. This has not only advanced our understanding of the role of oxygen ordering but also enabled 'cleaner' measurements of many physical properties.

High-quality thin films. Epitaxial HTS thin films grown on lattice matched single-crystal substrates have also been used extensively in basic studies of physical properties of these materials. In many experiments one can take advantage of the thin film geometry, such as the capability to lithographically define fine features and the potential to synthesize custom-tailored multilayers or superlattices. In the last two decades, there has been rapid development of many different techniques of HTS thin film growth. Some have been already adapted to deposition of other superconductors (e.g., MgB_2 and $\text{RNi}_2\text{B}_2\text{C}$) and a range of other compounds. Some dominant methods in use today are sputtering and laser ablation (also referred to as pulsed laser deposition, PLD) from a single target or from multiple, interchangeable targets.

Advanced techniques such as molecular beam epitaxy (MBE) have been developed as well. Ozone or atomic oxygen is used to achieve sufficient oxidation under ultra-high vacuum conditions. This has enabled growth of atomically smooth, single-crystal thin films with the properties either matching or exceeding those found in bulk crystals. For example, the record $T_c = 51.5$ K in LSCO thin films is significantly higher than in the bulk ($T_c < 40$ K). This enhancement is partly attributed to (compressive) epitaxial strain.

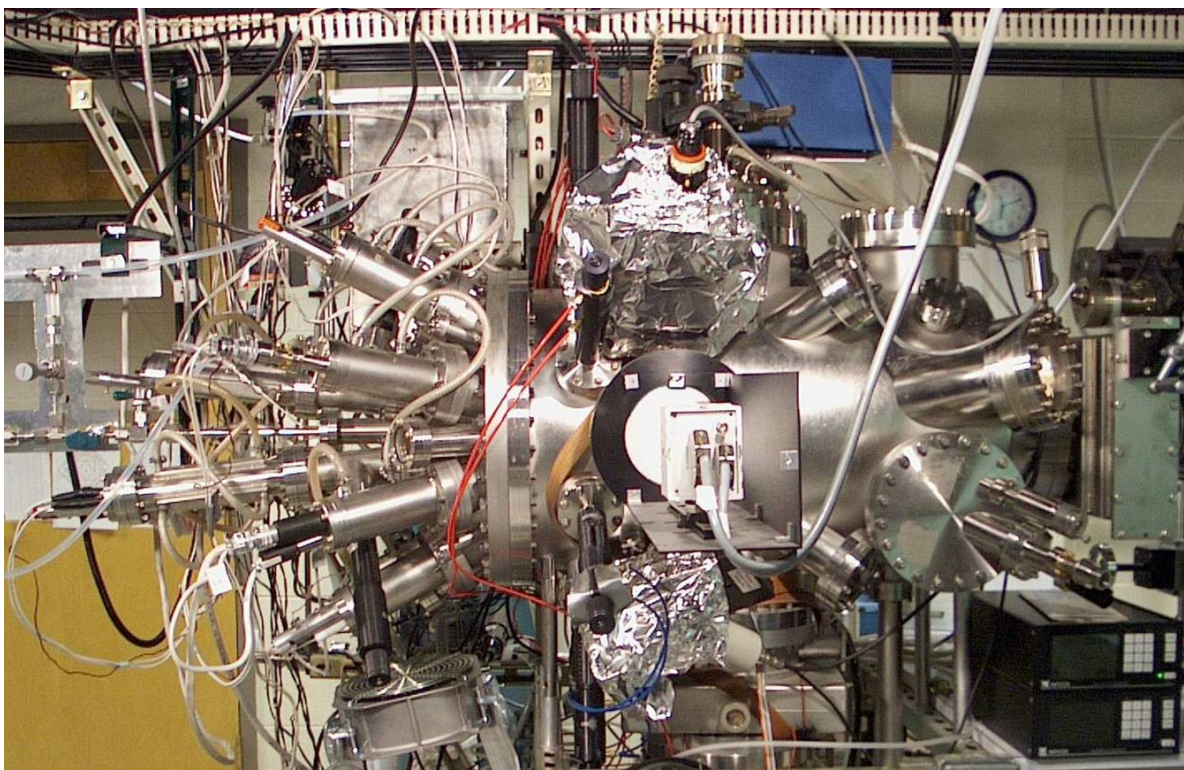

Figure 4 Atomic-layer-by-layer molecular beam epitaxy system for growth of thin films of cuprates and other complex oxides. The system is equipped with twelve metal atom sources, an ozone beam, reflection high energy electron diffraction and atomic absorption beam flux monitors. [J. Eckstein, UIUC]

Other notable achievements include the deposition of one-unit-cell thick HTS layers with bulk T_c values, as well as trilayer films with HTS electrodes separated by 4 Å thick insulating barriers without any pinholes. Such multilayer structures enabled some unique experiments to be done that shed new light on important physics problems, such as the AFM/HTS phase separation, creation of midgap states upon doping, Giant Proximity Effect between optimally doped and underdoped cuprates, etc.

SOME OUTSTANDING MATERIALS-RELATED ISSUES

Bulk samples, single crystals. Some of the critical open problems are (i) improving sample purity in many exotic, organic and some heavy fermion superconductors, (ii) understanding and eliminating sample dependence, (iii) understanding and controlling defects, dopants and disorder, and (iv) improving j_c , H_{c2} and T_c in all classes of materials. Another critical task is the growth of large single crystals of a much broader range of superconducting materials, in particular for the next generation of neutron scattering studies at the most powerful neutron source, SNS at ORNL. These problems can be best addressed by having research focused not only on improvements of known compounds, but by improvements in existing growth techniques and the creation of new ones. New fluxes, new transport agents, and new methods of temperature, temperature gradient and nucleation control will all lead to better control over sample size, quality, and reproducibility.

Thin films. For thin films of all types of superconductors the most basic need is a study of preparation of substrate surfaces and how they affect film growth; this should lead to more reproducible deposition conditions and improved control of film synthesis. Further improvement is needed in techniques for synthesis and characterization of thin films, as well as their extension to a much broader range of superconducting compounds. Atomic-level control should be achieved for film nucleation and growth, and for interfaces. The ultimate goal is to make clean interfaces in hetero-structures such as superconductor-insulator multilayers where the electrical properties are preserved up to the interface. This requires detailed study of the nucleation of materials on the substrate surface as the film grows, and more generally of various aspects of interface physics. Ultimately this should provide guidelines on how to synthesize desired structures, as well as understanding the limitations of present techniques. Much more needs to be learned about possibilities and limitations in atomic-layer engineering of multilayer and superlattice structures, which should open the path to sophisticated heterostructure and device architectures.

SYNTHESIS AND STUDY OF NANO-STRUCTURED SUPERCONDUCTORS

Complex and nano-scale materials always exhibit (a) substantial disorder due to the presence of boundaries, crystalline and chemical defects, inhomogeneous strain etc., and (b) “proximity effects” due to contact with other dissimilar materials including unwanted oxides, contamination, substrates etc. The smaller the physical size, the more (proportionally) the electronic wave-functions, magnetic and electric fields extend outside the structure. Thus in addition to understanding the materials on their own, it is important to understand their properties when they are in proximity to other materials and when their size is reduced to the nanoscale.

Nanoscale superconductivity, in particular, is of interest due to (a) possible applications of ultra-small superconducting devices and (b) new quantum effects which arise when all or some of the system dimensions become comparable to various length scales characteristic of the material, such as the penetration depth, coherence length, grain size or unit cell size. Superconductors have been cast as ultra-thin films, one-dimensional wires, and quantum dots, which correspond to two-, one- and zero dimensional (2D, 1D, 0D) systems. One can also include both lateral and vertical artificial structures such as junction or wire networks, or multilayer heterostructures.

In the last two decades, there has been much progress in fabrication and characterization of nano-structured superconductors, including nano-particles, quantum dots, nano-wires, ultra-thin films, and superlattices in which individual layers are only a few nm thick.

Fundamental nano-scale phenomena and processes. The nature of the superconducting state depends crucially on spatial dimensionality. For 3D the superconductivity is most robust; in superconducting wires and thin films, thermal and quantum fluctuations play a crucial role and may modify the electrical transport across a weak link.

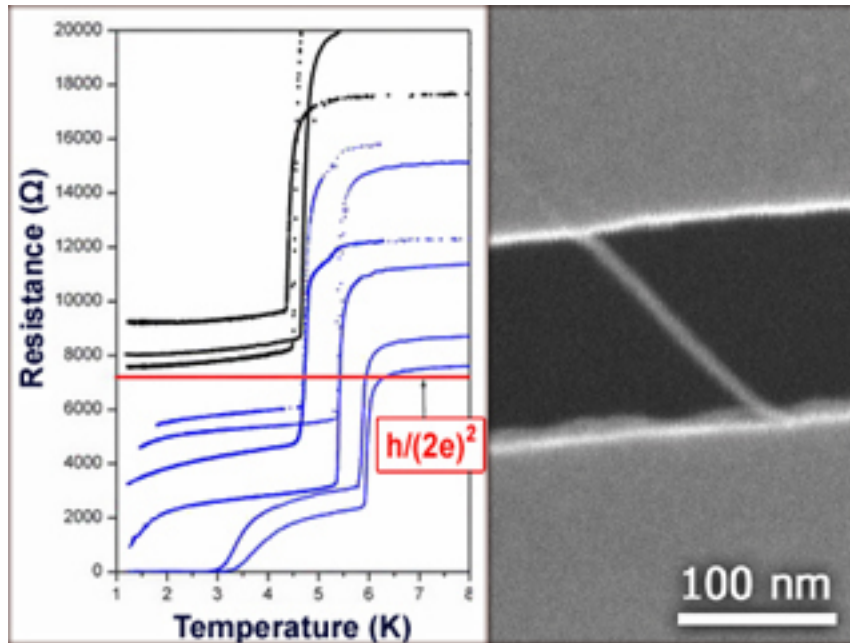

Figure 5 Superconductor-insulator transition in nanowires. **Left panel:** Observed superconductor-insulator transition in nanowires. The black curves correspond to insulating and the blue curves to superconducting samples. The critical point coincides approximately with the superconducting resistance quantum $h/4e^2$. **Right panel:** A nanowire fabricated by a carbon nanotube template. [A. Bezryadin, UIUC]

More experiments in readily accessible 2D superconducting films are necessary. For example, it was recently predicted that a thin film does not reach a state of zero resistance except at zero temperature. Ultra-thin superconducting wires seem also to withstand stronger magnetic fields than larger wires made from the same material.

In HTS materials, most of the fundamental length scales are on the nano-meter scale (e.g. single-crystal domains, coherence length, stripes). Therefore, experimental investigation of structures on this scale can be vital to the understanding of the microscopic mechanism.

Main accomplishments

0D: nano-scale tunnel junctions. There have been a number of experiments on completely confined systems. The ability to produce low-capacitance and small-size tunnel junctions enabled investigations of the transition between Josephson-like and charge-like behavior in individual Josephson junctions and in junction arrays. The latter is a physical example of the phase-only model of the superconductor-insulator transition, while the former exhibit transitions in which dissipation damped out quantum fluctuations leading to superconducting behavior. A superconductor-insulator transition could thus be controlled through the damping of quantum fluctuations by dissipation. The technology of fabricating ultra-small junctions is central to the development of junction configurations which are realizations of qubits, the fundamental element of a quantum computer. Investigations of double tunneling junctions involving small intermediate electrodes have revealed features of the Coulomb blockade as well as odd-even effects on superconductivity.

1D: nanowires. With the ready availability of electron-beam lithography, it has become feasible to fabricate structures on length scale of the order of the superconducting coherence length. This stimulated the study of the physics of superconducting nano-wires produced by lithography, by electrochemical techniques, and by templated growth using carbon nanotubes as scaffolds. A recent curious result is the report of an inverse proximity effect in a

wire – the observation that when the electrodes connected to the wire are superconducting the superconductivity of the wire is suppressed. This may be an example of dissipation control of superconductivity. Another result is the complete disappearance of superconductivity in wires with strong enough disorder (Superconducting Insulator Transition in 1D). Such a quantum transition was observed in nanowires templated by molecules. The critical point can either be given in terms of the critical resistance or the critical diameter. The critical resistance is close to the quantum resistance ($h/4e^2$) and the experimentally observed critical diameter is ~ 6 nm.

Nano-wire networks. Superconducting nano-wire networks served as model systems for the study of the complex fractal solutions to the Schroedinger equation in a magnetic field on such networks.

2D: ultrathin films. The availability of ultrathin superconducting films provided an arena for the study of topological phase transitions, i.e., the so-called Kosterlitz-Thouless-Berezinskii transition, which is an important paradigm in contemporary condensed matter physics.

Superconductor-insulator transition. Further reduction of the thickness of disordered films, resulted in the realization of superconductor-insulator (rather than superconductor-metal) transitions, tuned by changing the level of disorder, by applying a magnetic field, or by electrostatic charging. These are notable examples of quantum phase transitions, of great recent interest. However, their detailed nature is not yet understood.

2D: heterostructures and superlattices. Vertical structures involving interfaces between different materials may have properties rather different from those of the constituent materials. Heterostructures and sandwich junctions with ultrathin barriers have been used to study interplay between superconductivity and another, competing order parameter. Of particular interest are interfaces between superconductors (S) and ferromagnets (F) or anti-ferromagnets (AF). In FSF trilayer structures, transport through the ferromagnet has resulted in a π -junction (where the phase jumps by π in the *ground* state). A variety of superlattices with ultrathin (nano-scale) constituent layers has been synthesized and studied. Much attention has been devoted recently to SFSFS... superlattices. A variety of unusual, quantum phenomena, such as oscillations of T_c and j_c as a function of the thickness d_F of the F layer, have been predicted and observed.

Some key outstanding problems

The investigation of properties of unconventional novel superconducting materials, such as the high- T_c cuprates, Sr_2RuO_4 , or heavy-Fermion superconductors, in restricted-dimension geometries is an area that has hardly been touched.

Magic nano-clusters with high T_c . Recently there was a theoretical proposal that spherical superconducting clusters with “magic numbers” of electrons could exhibit superconductivity at very high temperatures. This should be true even for clusters of simple metals such as Al, Ga, Zn, Cd; for example, Ga_{56} is predicted to have $T_c \approx 150$ K. A network of such clusters can be formed on a surface and sustain a supercurrent at high temperatures. The phenomenon is based on the presence of the so-called “shell” structure discovered by W. Knight et al., in 1984. This event was virtually unnoticed by the superconductivity community, overshadowed by the discovery of HTS in the cuprates in 1986. Presently, the study of nano-clusters is a well-developed field, and observation of superconductivity in these clusters should be viable. The experiment requires one to measure the excitation spectrum of a selected cluster at low temperature and at $T > T_c$; the pairing would lead to a large difference between the two. The necessary techniques are already in place: mass spectroscopy, preparation of beams at different temperatures, and photoemission spectroscopy. There has also been a noticeable progress in growing isolated clusters in a matrix and molecular crystals in which clusters form an ordered 3D lattice.

Quantum fluctuations and strong correlations in nano-wires. The precise role of quantum fluctuations in superconducting nano-wires is not yet settled. The question is of technical interest for low temperature superconducting electronics because it may set a limitation on the length scale.

In the extreme 1D limit, the conventional Fermi liquid theory fails, and is replaced by the so-called Tomonaga-Luttinger liquid theory. In the latter there are no quasiparticles; the excitations of the system are collective with the spin and charge degrees of freedom completely decoupled and separately excitable. This has been observed in wire

systems based on GaAs heterostructures. A very interesting open question is the nature of the interplay between superconductivity and Luttinger liquids, and whether a Luttinger liquid itself can become a superconductor.

Ultrathin films. Open questions in this arena include whether there is an intermediate metallic regime for these two dimensional systems, in which the charge carriers are Cooper pairs rather than electron-like quasiparticles, and whether the insulating state is a new state of matter in the form of a Bose insulator. Another question is whether there is a strong analogy between insulating behavior in ultra-thin films and the pseudogap regime of underdoped cuprate superconductors.

Giant Proximity Effect. Penetration of superconducting correlations into a normal metal (N), the superconducting proximity effect, is a well established phenomenon occurring due to the coherent nature of electron transport through an N/S interface, a process known as Andreev reflection. In the case of cuprates, there is the mystery of the long-range proximity effect, which has clearly been observed, but is not understood in a definitive manner.

Spin injection. Although there have been interesting spin injection experiments in ferromagnet/superconductor bilayers and junctions there are as yet no quantitative experiments, and phenomena such as spin accumulation have not been characterized. The Andreev reflection has emerged as an important approach to the characterization of spin polarization of ferromagnets. The Andreev current should be suppressed to the extent of the spin polarization, P , of the conducting electrons, reflecting the ratios of the densities of states and Fermi velocities. One thus expects that there will be no influence of S on F beyond some relatively short length. However, a few recent experiments have reported a long-range proximity effect. An important question for potential device applications of ferromagnets as sources of spin-polarized currents is the spin relaxation rate near the FS interface. This rate is a measure of the efficiency of spin injection, which is a key process in spintronics (electronic devices where spin of electrons is used to control the conductance of a device). It is known that quasi-particles enter the superconductor via the Andreev reflection process involving quasi-particles from opposite spin bands. Thus, electron transport from F into S reflects spin polarization of F or, in case of a fully polarized F, the degree of spin relaxation. Spin-valve-type experiments should test the efficiency of spin filtering by S by studying prototypes of possible real devices.

Nano-scale superconductors and hybrid structures. Here, some topical subjects are: fluctuations in nanoscale superconductors and Josephson arrays, noise and dynamics in nanoscale superconductors; Andreev states and coherent phenomena: tunneling and vortex dynamics in small Josephson circuits and Josephson arrays; non-stationary effects in mesoscopic superconductors; ferromagnet/superconductor heterostructures; etc. The variety of the naturally occurring multilayers can be further extended via atomic-layer-by-layer molecular beam epitaxy, also allowing design of a new class of functional heterostructures involving spin effects. These heterostructures will moreover permit fundamental studies of interactions between magnetically ordered and superconducting regions.

Nanomaterials. Materials science has experienced spectacular progress during the last decades. This development, however, is only the beginning and we can expect that also in the future revolutionary nanoscale superconductor materials will be developed for various areas such as information storage, microelectronics, etc. Challenges for the future are to design and synthesize new materials with well-controlled properties. This will need new methods to model, synthesize and characterize materials. In particular, there are strong needs for new methods to structure and organize materials in 1D and 2D with various degrees of complexity and with wide ranges of length scales. Three important topics of research can be identified: new computational methods and synthesis processes; control of surface (interface) processes, and development of new processes for structuring, including self assembly.

Nano-manufacturing. In order to fabricate, manipulate, and study these nanoscale systems with high precision we need very specialized tools and methods. These technologies are necessary for the success of research. Characterization of new materials will also become more demanding since future materials also will include hierarchical structures and materials with chemical modulation. An important challenge will be to develop new *in-situ* techniques to study kinetics and mechanisms in materials synthesis in a wider range of pressures and temperatures and also follow how the properties develop during synthesis. An example is the so-called laser focused deposition technique which is compatible with MBE (lateral structuring during growth of thin films in UHV).

Instrumentation research, metrology, standards for nanotechnology. To do qubit and quantum transport research very specialized tools must be developed such as a scanning SET microscope in order to study charge distributions on surfaces, TEM studies of tunnel barriers providing information about surfaces and internal interfaces, etc. Further

development are necessary of new Nano Probes, in particular those that combine Scanning Probe with ultra-fast optical methods, nanomagnetic probes and nano-probes for rough surfaces and truly 3D imaging.

Research facilities and instrumentation. Developments in spectroscopy and electron microscopy (e.g. new detectors) and different scattering techniques (x-ray and neutrons) at the nanoscale will in parallel ensure our ability to study structure and bonding and, ultimately, obtain an atomic level relation between structure and function. As the limits of performance are pushed the figures of merit of nano-structured superconductors (junctions, wires, clusters, etc.) need to be optimized. Then knowledge about the (sub) microscopic nature of the structures and how they evolve are crucial. This requires detailed high-resolution characterization of the microstructure of the devices and correlation between structure, properties and fabrication parameters.

Proximity between superconductors and nanostructures. The combination of the proximity effect and nano-structuring can give rise to spectacular enhancements in the transport and magnetic properties of conventional superconductors. Such effects were observed and predicted a long time ago. However, the recent development of novel techniques for the preparation of nano-structured materials has considerably broadened the range of parameters and applicability of these ideas. For instance, the interaction between arrays of nano-structured magnetic particles and superconducting thin films can lead to interesting pinning effects due to synchronized interaction with the vortex lattice. Such arrays can be produced using a variety of e-beam lithography or self-assembly methods combined with thin film deposition techniques such as sputtering or MBE. The physical properties show very interesting periodic oscillations in the resistivity and magnetization which are related to the geometry of the pinning arrays. Non-symmetrically shaped magnetic nanostructures can produce unusual ratchet effects similar to biological ratchets. The interaction between the vortex lattice and a periodic array of nano-structures has been predicted to give rise to Josephson-like effects in a frequency range which can be tuned by the external magnetic field.

The boundary conditions and geometry of nanoscopic interfaces involving superconductors can also lead to new electronic structure based on how the proximity effect modifies both materials. For example, the usual specular reflection of electrons at an interface involving superconductors must be modified to include Andreev reflections and these give rise to new kinds of standing wave states inside small samples. The modified and spatially dependent density of states that results is an example of how nanoscopically precise interfaces can give rise to new behavior controlled at least in part by geometry. Perfect interfaces to semiconductors are a particularly interesting example of this, since long-range coherence is possible in high mobility electron and hole gas layers.

In general, the proximity between dissimilar materials and nanostructures produces interesting commensuration effects with many possible combinations, and this presents new research opportunities.

FURTHER READING: SUPERCONDUCTING MATERIALS

1. J.G. Bednorz and K.A. Muller, "Possible high T_c superconductivity in the Ba-La-Cu-O system," *Z. Phys. B* **64**, 189 (1986)
2. M.K. Wu, J.R. Ashburn, C.J. Torng, P.H. Hor, R.L. Meng, L. Gao, Z.J. Huang, Y.Q. Wang, C.W. Chu, "Superconductivity at 93 K in a New Mixed-Phase Y-Ba-Cu-O Compound System at Ambient Pressure," *Phys. Rev. Lett.* **58**, 908 (1987)
3. K. Tanigaki, T.W. Ebbesen, S. Saito, J. Mizuki, J.S. Tsai, Y. Kubo and S. Kuroshima, "Superconductivity at 33K in $Cs_xRb_yC_{60}$," *Nature* **352**, 222 (1991)
4. L. Gao, Y.Y. Xue, F. Chen, Q. Xiong, R.L. Meng, D. Ramirez, C.W. Chu, J.H. Eggert, H.K. Mao, "Superconductivity up to 164 K in $HgBa_2Ca_{m-1}Cu_mO_{2m+2+d}$ ($m = 1, 2, \text{ and } 3$) under quasi-hydrostatic pressures," *Phys. Rev. B* **50**, 4260 (1994)
5. R.J. Cava, H. Takagi, B. Batlogg, H.W. Zanderbergen, J.J. Krajewski, W.F. Peck, R.B. Vandover, R.J. Felder, T. Siegrist, K. Mizuhashi, J.O. Lee, H. Eisaki, S.A. Carter and S. Uchida, "Superconductivity at 23 K in yttrium palladium boride carbide," *Nature* **367**, 146 (1994)

6. D. Lederman, D.C. Vier, D. Mendoza, J. Santamaria, S. Schultz, and I.K Schuller, "Detection of New Superconductors Using Phase-Spread Alloy Films," *Appl. Phys. Lett.* **66**, 3677 (1995)
7. P.C. Canfield, P.L. Gammel and D. Bishop, "New Magnetic Superconductors: A Toy Box for Solid-State Physicists," *Physics Today*, October 1998 p. 41
8. J. Nagamatsu, N. Nakagawa, T. Muranaka, Y. Zenitani and J. Akimitsu, "Superconductivity at 39 K in magnesium diboride," *Nature* **410**, 63 (2001)
9. J.L. Sarrao, L.A. Morales, J.D. Thompson, B.L. Scott, G.R. Stewart, F. Wastin, J. Rebizant, P. Boulet, E. Colineau and G.H. Lander, "Plutonium based superconductivity with a transition temperature above 18 K," *Nature* **420**, 497 (2002)
10. K. Shimizu, H. Ishikawa, D. Takao, T. Yagi, K. Amaya, "Superconductivity in compressed lithium at 20 K," *Nature* **419**, 597 (2002)
11. E.A. Ekimov, V.A. Sidorov, E.D. Bauer, N.N. Mel'nik, N.J. Curro, J.D. Thompson, and S.M. Stishov, "Superconductivity in diamond," *Nature* **428**, 542 (2004).
12. T.H. Geballe, "Discovering new superconductors: a path to new science and higher T_c ," in *Strongly Correlated Electron Materials: Physics and Engineering*, ed. by I. Bozovic and D. Pavuna (SPIE Proc. 5932, Bellingham, 2005) p. 1S.

Phenomenology of High Temperature & Exotic Superconductivity

The purpose of this section is to provide an overview of progress in understanding the physical phenomena that underlie superconductivity in the high- T_c cuprates, as well as other “exotic” superconductors. In characterizing progress two stories emerge – one is clearly a success story and the other may be best characterized as laying the groundwork for future success. The overwhelming success is the development and use of powerful new tools to examine superconductors with spatial and spectral resolution that were unanticipated before the advent of high- T_c . While ARPES and STM spectroscopies are perhaps the most spectacular successes, tremendous progress has been made in neutron scattering methods, as well as optical spectroscopy from microwave to X-rays. At the same time traditional methods, such as magneto- and thermal transport have become ever more refined in accuracy and interpretation and transport/thermodynamic studies are becoming possible in magnetic fields up to 60 Tesla. The success story for the future is unraveling the mechanism for high- T_c superconductivity. Although the meaning of “mechanism” can be debated, it is nevertheless clear that there is no consensus in the scientific community on the simple question of what is the special ingredient that enables the cuprates to superconduct at temperatures two to four times higher than any other material.

KEY PHYSICAL PHENOMENA OF COPPER OXIDE SUPERCONDUCTIVITY

Here we present a thumbnail sketch of the present state of knowledge on key physical phenomena of the hole-doped (those with highest T_c) cuprate superconductors. Of necessity it is incomplete.

Antiferromagnetic Charge-Transfer Insulating Parent State

The cuprate high critical temperature superconductors (HTS) all have one crystalline structure in common: the CuO_2 plane. This comprises a square lattice of Cu and O atoms with a Cu-O-Cu distance of about 3.8 Å. Outside this plane, the crystalline structure can be extremely different while still allowing the system to exhibit HTS, albeit at a wide variety of T_c values.

In the CuO_2 plane of the parent insulating state, the Cu atoms are believed to be in the $\text{Cu}^{2+} 3d^9$ configuration while the O atoms have closed p-shells in a $2p^6$ configuration. This CuO_2 system is referred to as a charge transfer insulator (CTI). The on-site Coulomb energy (Hubbard energy U) splits the d-band into two, a lower filled band and an upper empty band. The filled oxygen p-orbitals intervene, separated from the empty upper d-band by the charge transfer energy Δ .

Since this is a system comprising three electronic bands, it is somewhat surprising that it can be modeled as a half-filled single band Mott insulator. The reason why this simplification is applicable is the demonstration by Zhang and Rice that, when the O p-orbital is occupied with a single hole, the remaining single electron in that orbital hybridizes with single electron in the lower Cu d-orbital forming the famous Zhang-Rice Singlet (ZRS). This ZRS state can then be used as the basis of a single-band model of the doped cuprate CTI electronic structure. Some researchers, however, feel that this may be an over simplification and the full three band model will be required to fully understand the electronic structure of cuprates.

Hole-doped Phase Diagram

Hole-doping of the CuO_2 plane is usually achieved either by substituting more electronegative atoms on a lattice site or by introducing electronegative interstitial oxygen atoms. The density of holes per CuO_2 plaquette p is the key parameter in the phase diagram. As the planar hole-density increases, the long-range antiferromagnetic state (green in Fig. 6) quickly

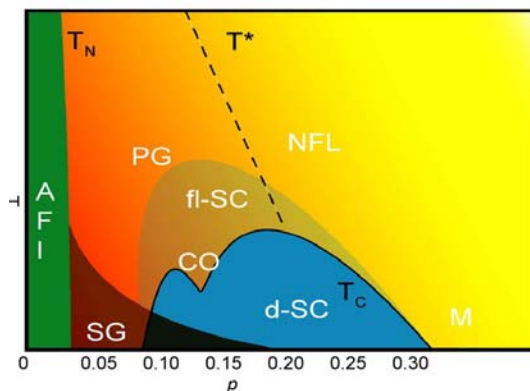

Figure 6 Schematic electronic phase diagram of the cuprates: AFI terminates near $p \sim 3\%$. The d-SC appears near $p \sim 10\%$ and disappears near $p \sim 25\%$ with a metallic state (M) existing for higher dopings.

disappears, leaving behind some short range antiferromagnetic correlations. Typically by $p \sim 3\%$, the disappearance of the AF state reveals a new state which intervenes between the insulator and the high- T_c superconductor (dark red region Fig. 6). This state has yet to be identified.

‘Cluster’ Spin Glass State

Approaching zero-temperature in this unknown state (dark red region in Fig. 6), a wide variety of local probes such as μ SR, NMR/NQR and powder neutron diffraction indicate that a so-called ‘cluster’ spin and charge glass exists in most cuprates. The exact spatial structure of the ‘clusters’ are unknown at present, but all these probes indicate that there is some very short range form of ordering in both spin and charge-density distribution but no long range order is detected by these probes. In addition, the crystal lattice is often spontaneously disordered on the nanoscale, most likely due to the nanoscale variations in hole-density.

At higher hole densities below 10% (but varying between different cuprate families), the first vestiges of superconductivity begin to appear with very low critical temperatures and hole densities. In this regime the ‘cluster’ spin/hole glass signatures usually coexist with the tenuous superconductivity. It is still not known if these phenomena are phase separated in space at the nanoscale or if they coexist spatially. Eventually, at relatively high doping, near so-called optimum $\sim 16\%$ for which T_c is highest, the ‘cluster’ glass signatures have faded away.

Recently another very unusual phenomenon has been discovered in this cluster spin/charge glass part of the phase diagram. Spectroscopic imaging scanning tunneling microscopy (SI-STM) reveals that the density of electronic states, both in the non-superconducting and the superconducting samples, is modulated in a so-called ‘checkerboard’ fashion (see Fig. 7). The electronic structure breaks rotational and translational invariance, exhibiting no long-range order but short range correlations with periodicity $4a_0 \times 4a_0$. This same state has been demonstrated by ARPES to occur via scattering across the narrow neck of the Fermi surface (red arrow in Fig. 7, right panel). Its relationship to superconductivity has yet to be determined.

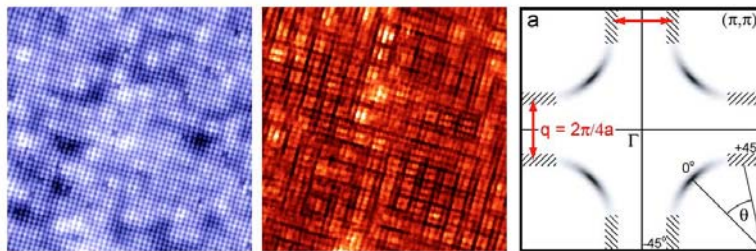

Figure 7 Left panel: 40nm square topographic image of Na-Ca₂CuO₂Cl₂ showing the square lattice of Cl atoms which are directly above the Cu sites. **Center panel:** Simultaneous 40nm-square LDOS image at -24meV: the LDOS patterns seen at three different dopings ($p = 0.08$ ($T_c=0$), 0.10 ($T_c=15$ K), 0.12 ($T_c=21$ K)) are almost identical. **Right panel:** ARPES reveals that the LDOS modulations are caused by scattering across the narrow neck of the Fermi surface with $q=2\pi/4a_0$.

Spin-Charge Ordered ‘Stripes’ Regime

For a few cuprates as doping approaches $p \sim 1/8$, dramatic changes occur in the electronic structure with the appearance of the static ‘striped’ state. This state is believed to consist of a unidirectional structure with parallel lines of spin modulations which repeat every $8a_0$ and charge modulations which repeat every $4a_0$: thus the term ‘stripes’(see Fig. 8a).

The most well studied examples of this state occur in LaBaCuO & LaNdSrCuO in which T_c can be driven down close to zero by the appearance of the striped state. The occurrence of long range ordered stripes is also coincident with a phase transition which diminishes the crystal symmetry.

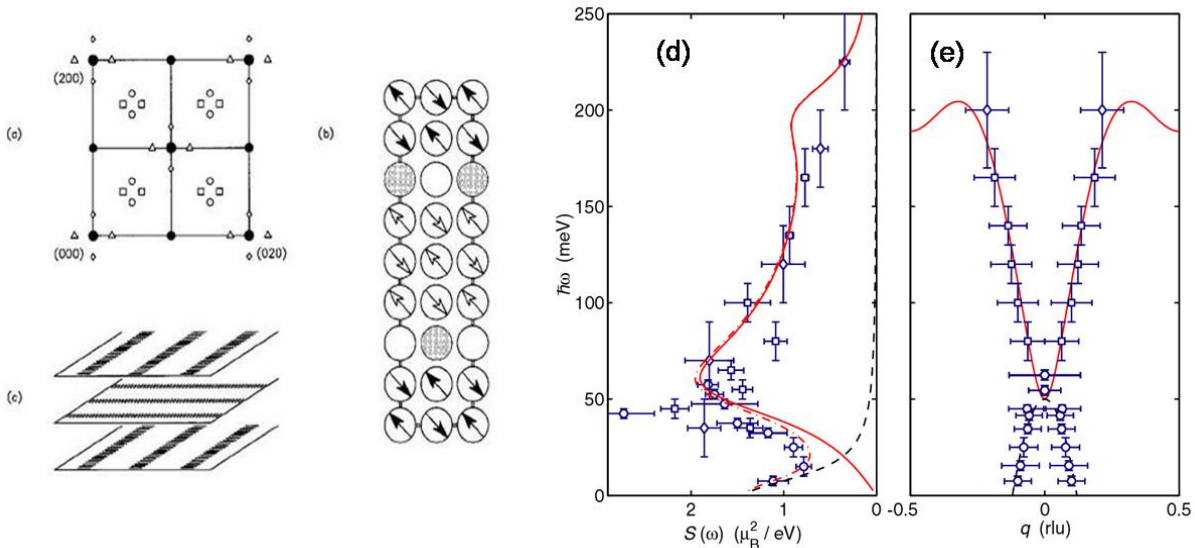

Figure 8 **a.** A schematic representation of a striped state. **b.** The spin orientation has a repeat pattern every $8a_0$ while the hole density has a $4a_0$ periodicity - both in a unidirectional structure. **c.** The square symmetry of the neutron scattering data is thought to occur due to stripes of alternating directions in different planes **d.** Spin density wave intensity and **e.** dispersion of LaBaCuO.

Static long range ordered stripes are unknown in most cuprates. However, in many, a dip in T_c (shown schematically in Fig. 6) occurs near $p \sim 1/8$ as if this ordered state and its suppression of T_c are always incipient. An outstanding question is if a dynamical version of such unidirectional spin/charge ordering can be supportive to superconductivity.

Universal Spin Excitation Spectrum

One of the most important recent discoveries is that the excitation spectrum for spin density waves in the cuprates is universal. The spectrum for striped LaBaCuO where $T_c \rightarrow 0$, along with its magnetic intensity at each energy, is shown in Fig. 8b. This spectrum is almost identical at high energy to that of YBCO where $T_c \sim 90K$. A closely related spectrum is found in LaSrCuO. The universality of the spin excitations is an important unification of the magnetic phenomenology. Its significance for the mechanism and strength of superconductivity, and the phase diagram, remains to be determined.

The existence of such a universal magnetic excitation spectrum raises several crucial questions. How do we understand this magnetic spectrum and its connection with the superconductivity? There have been two basic approaches: 1) the magnetism is associated with excitations of quasiparticles across the Fermi surface, with substantial enhancement due to interactions; 2) the excitations are associated with local magnetic moments coupled by superexchange, as in the case of stripe correlations. And of central importance: are these universal magnetic excitations associated with the mechanism of the superconductivity in some way?

d-wave Superconductivity

Between doping $p \sim 10\%$ and $p \sim 25\%$, the d-wave superconductivity appears (blue in Fig. 6). Early indications from the temperature dependence of the superfluid density were that these were nodal superconductors. Phase sensitive tests of the order-parameter symmetry, using corner junction SQUIDS and scanned SQUID experiments on specially prepared tricrystals (see Fig. 9), have amply demonstrated that, throughout the phase diagram, the predominant order-parameter symmetry is d-wave.

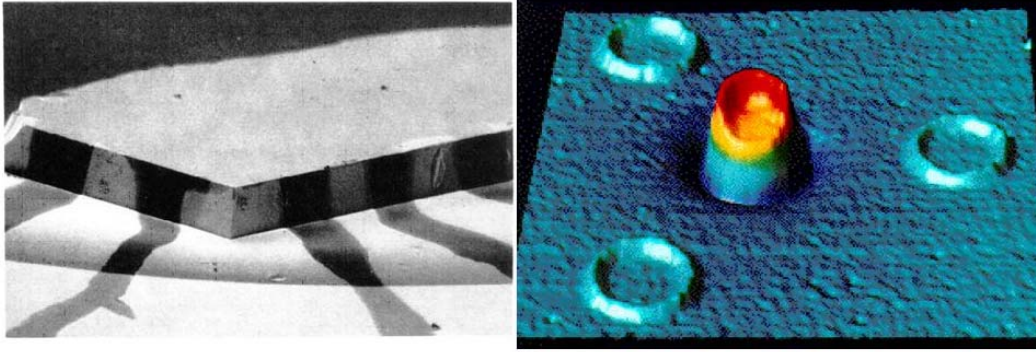

Figure 9 Experimental approaches to test the order parameter symmetry in the cuprates. **Left panel:** A corner junction SQUID. **Right panel:** half-flux quantum detected at the meeting point of a tri-crystal sample.

A tremendous amount is now known about the d-wave superconductivity. The flux is quantized in units of $h/2e$, showing that pairing is essential. The phenomenology of the vortex lattice and crystal and its relevance to high current applications appear elsewhere in this factual document. The momentum space electronic structure has been mapped with exquisite precision.

For example, a strong dichotomy appears between the states near the gap node and those ‘antinodal’ states near the zone-face $k \sim (\pi/a_0, 0)$. Above T_c near-nodal coherent states on the ‘Fermi Arc’ appear at very low doping or while the antinodal states are gapped, presumably by the same phenomenon as the pseudogap, and only become coherent in the overdoped regime.

However, the key physical phenomenon which enables the cuprates to superconduct at high temperatures (in a fashion largely indistinguishable from d-wave BCS state at optimal and overdoping) has yet to be determined unambiguously.

Pseudogap Regime

At higher temperatures above both the spin/hole cluster glass state and the d-SC state but at dopings below about 20%, the ‘pseudogap’ regime is observed (orange in Fig. 6). It is bounded above by a crossover temperature T^* where many phenomena change smoothly but no phase transition has been detected. As temperatures fall below T^* , the pseudogap regime is characterized by strong reductions in the uniform magnetic susceptibility, reductions in the entropy of the electronic system, opening of a wide gap in the electronic density of states, a diminution in the ab-plane DC -resistivity, and increase in the c-axis resistivity and many other unusual phenomena.

Among the proposed explanations for the pseudogap regime are that (i) it is a necessary element of resonating-valence-bond RVB superconductivity or (ii) it is due to a competing electronic phase. The latter include 2-d antiferromagnetism, staggered flux phases, valence bond solids, d-density waves, intra-unit-cell orbital currents, spin and charge density waves and unidirectional stripes. A coherent physical explanation for the pseudogap regime is one of the key outstanding issues in cuprate studies.

Fluctuating Superconductivity Regime

Above T_c , the fluctuating superfluid condensate may be detected by measurements of its kinetic inductance at THz frequencies. When superconducting coherence is lost at the transition temperature T_c , pairing remains, together with phase correlations which are finite in space and time. Measurements of high-frequency conductivity track the phase-correlation time τ in the normal state of $\text{Bi}_2\text{Sr}_2\text{CaCu}_2\text{O}_{8+\delta}$. Just above T_c , τ reflects the motion of thermally generated topological defects in the phase, or vortices. However, vortex proliferation reduces τ to a value indistinguishable from the lifetime of normal-state electrons at 100 K, well below T^* .

There is another technique with which to examine the fluctuating condensate: if a temperature gradient exists, vortices can flow down the gradient much like a viscous liquid. The AC-Josephson equation then predicts that if a line is drawn perpendicular to the vortex-flow direction, a voltage appears between the ends of the line. This Josephson voltage is proportional to the number of vortices crossing the line per second. Such experiments at $T > T_c$ have uncovered many interesting properties. The Nernst signal in cuprates is unusually large. Significantly, in all the hole-doped cuprates investigated, the vortex signal continues to survive to temperatures high above the critical transition temperature T_c . These results indicate that, in the cuprate phase diagram, vortices appear to exist over a large region (the “Nernst region”) which extends to an onset temperature T_{onset} that is 2-3 times higher than T_c but well below T^* at low doping.

Recently, high-resolution torque magnetometry has confirmed that, throughout the Nernst region, the cuprates display a diamagnetism that is strictly 2D. The diamagnetism (induced moment opposite to field) provides strong evidence for the existence of weak local supercurrents in the vortex liquid. As T is lowered below T_c , the diamagnetic signal smoothly grows to become the well-known Meissner signal consistent with flux expulsion.

High Magnetic Fields

The behavior of superconductors in high magnetic field is of critical importance for many reasons. The obvious one is vortex pinning and high critical currents (discussed below). However fundamental issues have also been explored with very high magnetic fields. These include studies of the quenching of HTS by very high fields to reveal a non metallic normal state (which has yet to be identified) at low doping in a variety of cuprates.

The evolution of the low-temperature Hall coefficient in the normal state can also be determined as the carrier density is increased, from the onset of superconductivity and beyond. It does not vary monotonically with doping but rather exhibits a sharp change at the optimal doping level for superconductivity. This observation supports the idea that two competing ground states underlie the high-temperature superconducting phase.

Further, high-field nuclear-magnetic-resonance (NMR) imaging experiment can spatially resolve the electronic structure of near-optimally doped $\text{YBa}_2\text{Cu}_3\text{O}_{7-\delta}$ inside and outside vortex cores. Outside the cores, one finds strong antiferromagnetic fluctuations, whereas inside one detects electronic states that are rather different from those found in conventional superconductors.

Electron Boson Interactions

Extensive studies of bosonic modes and related electronic self-energy changes have been carried out in search of an electron-boson interaction involved in the mechanism of HTS. Effects of EBI on electronic self-energies are most widely studied via angle resolved photoemission (ARPES). Along the nodal direction of momentum space from $(0,0)$ to (π,π) where $\Delta=0$, sudden changes or “kinks” in quasiparticle dispersion $E(k)$ occur between 50meV and 80meV below the Fermi energy. Several studies have addressed the issue of whether these “kinks” might be due to magnetic interactions. On the other hand, Lanzara *et al* proposed that, because of the doping independence of their energies, the “kinks” are due to electron-phonon interactions.

In the antinodal directions $k \approx (\pi/a_o,0)$ where Δ is maximal, self energy changes also occur between 50meV and 90meV below the Fermi energy. But here the effects are thought to occur at $E=\Delta+\Omega$. The modes have been widely discussed in terms of both magnetic interactions and electron phonon interactions. Gweon *et al* demonstrated effects of $^{16}\text{O}/^{18}\text{O}$ isotope substitution primarily on these antinodal states, providing clear evidence for electron-lattice interactions at high energies. Another pioneering EBI study technique is superconductor-insulator-superconductor (SIS) conductance measurements in break junctions; clear EBI features are detected and analyzed in terms of magnetic modes. A final key probe of copper-oxide EBI is optical spectroscopy; it reveals self-energy changes that have been ascribed to magnetic interactions via a sharp mode or a broad continuum. Evidently, a definite conclusion for the identity of any pairing related EBI has proven elusive.

Fermi Liquid Metallic State

Finally, at high doping $p \gtrsim 0.25$, it is believed that a reasonably standard metallic state defined by a three dimensional Fermi surface and coherent Landau-quasiparticles comes into existence.

Summary

It seems reasonable to say that, while the quantity, reliability and precision of experimental data now obtainable on the cuprates is unprecedented, the “smoking gun” experiments to determine the mechanism and to understand the dependence of T_c on materials properties, have either not yet been carried out or not yet been recognized.

ADVANCES IN TECHNIQUES FOR HIGH TEMPERATURE SUPERCONDUCTIVITY

Here we discuss advances in physical measurement techniques which have been spurred by the complexity of the HTS problem and which represent one of the spectacular successes in this field. Of necessity it is also incomplete.

Angle Resolved Photoemission

The dramatic advances in angle resolved photoemission spectroscopy for cuprate studies have been widely reviewed. Among the many spectacular successes using ARPES are measurement of the basic electronic structure and Fermi surface, the detection of the d-wave superconducting gap, observation of an anisotropic pseudogap, discovery of the anisotropic quasiparticle dynamics (nodal - antinodal dichotomy), discovery of ‘kinks’ and the strong coupling like features due to electron boson coupling, and the demonstration that the doping process is a highly non-rigid band like evolution.

For the future, many developments can be expected in ARPES. With higher resolution it will become possible to explore if we (i) get mean free paths for the low energy excitations comparable to those measured in transport, (ii) resolve the spin charge separated components to the point where we can look at the temperature dependence of each separated component. The higher spatial resolution might contribute to understanding the STM pictures of BSCCO where one sees inhomogeneities. The STM really highlights the anisotropy of the gap as one crosses those regions so we might be interested in the local variation of the mean free path by locally measuring the nodal spectra. At high photon energies bulk studies will become possible although one has a loss of momentum resolution because the latter scales with the square root of the kinetic energy, one is more sensitive to the crystal mosaic for the same reason, the photon momentum is no longer negligible and at very high energies you generate a load of phonons in the excitation process. At lower photon energies there is longer mean free path maybe a factor of 4-5. Finally, new instruments will be required to offer a pathway to really high resolution and also the possibility of bringing time in as a variable in PES.

Spectroscopic Imaging STM

Spectroscopic imaging STM (SI-STM) for studies of atomic-scale electronic structure of cuprates has also advanced rapidly. Energy-resolved local density of states ($LDOS$) imaging is now possible. The *gap-map* technique in which superconducting energy-gap variations $\Delta(\vec{r})$ can be imaged with atomic resolution has been widely applied. Fourier transform scanning tunneling spectroscopy ($FT-STS$) allows \vec{q} -vectors of spatial modulations in $g(\vec{r}, E)$ to be determined from the locations of peaks in $g(\vec{q}, E)$, the Fourier transform magnitude of $g(\vec{r}, E)$. This technique has proven particularly valuable by virtue of its ability to relate the atomic-scale \vec{r} -space electronic structure to that in \vec{k} -space. Imaging of dopant atoms and their effects on the superconducting electronic structure is now possible, as is imaging of the electron boson interactions which renormalize the quasiparticles.

Inelastic tunneling spectroscopy with atomic resolution is just coming online for cuprate studies. In future it will allow access to the electron boson interactions of all different kinds at the atomic scale.

In high magnetic fields, a pseudogap-like conductance spectrum which exhibits associated $\sim 4a_0$ ‘checkerboard’ incommensurate *LDOS*-modulations can be regions proximate to each vortex core. And in the very lightly doped cuprate, $\text{Ca}_{2-x}\text{Na}_x\text{CuO}_2\text{Cl}_2$, a V-shaped energy gap supporting non-dispersive conductance modulations with $4a_0 \times 4a_0$ ‘checkerboard’ correlations has been observed.

Neutron Scattering

Neutron scattering has played a central role in cuprate studies, yielding many spectacular successes including the anti-ferromagnetic parent state and its destruction by hole-doping, the observation of ‘stripes,’ and universal spin excitation structure. There are currently high-quality facilities in the United States for neutron scattering studies of superconductors at the High Flux Isotope Reactor (Oak Ridge), the Lujan Center for Neutron Scattering (Los Alamos), the Intense Pulsed Neutron Source (Argonne), and the NIST Center for Neutron Research (Gaithersburg).

Exciting new opportunities will open up with the imminent completion of the Spallation Neutron Source in Oak Ridge. In terms of spectroscopy, it will become possible to efficiently map the dispersion of phonons and magnons in single crystals using the spectrometers ARCS (coming on line in 2007), SEQUOIA (2009), and HYSPEC (2011). One will be able to rapidly probe crystal structures and phase transitions of polycrystalline samples with the Powder Diffractometer (2007) and of single crystals with TOPAZ (2010). The properties of thin films and multilayers can be addressed with the Magnetism Reflectometer (2006). Thus, neutron scattering studies of the cuprate and other exotic superconductors will play a central role in the future of the field.

Optics

Microwave measurements in high- T_c superconductors are widely used. Measurement of kinetic inductance in the microwave regime is a direct probe of the superfluid density. Microwave research has recently focused on measurement of the parameters α and $\rho_s(0)$ in the formula $\rho_s = \rho_s(0) - \alpha T$, particularly as a function of hole concentration in the low-doping regime. These measurements are important for understanding the transition from the d-wave superconductor to Mott insulator states. The recent results suggest surprising deviations from both Uemura’s early empirical observation that T_c is a linear function of $\rho_s(0)$ and the expectation that α should be nearly constant as $\rho_s(0)$ tends to zero.

Terahertz frequency measurements are one of the areas where techniques have developed rapidly in response to the need to understand the properties of cuprate and other superconductors. The terahertz regime is of special importance because terahertz frequencies are in the range kT/h for technologically relevant temperatures. Terahertz measurements have been instrumental in revealing the Drude response of quasiparticles below T_c . The YBCO system appears to be unique in the cuprate family in that its Drude peak is extremely narrow, corresponding to quasiparticle scattering rates at low T of 10-100 GHz. In all other cuprate systems the quasiparticle Drude peak extends into the terahertz regime. The results point to the near ubiquity of the kind of nanophase disorder that has been clearly seen in the BSCCO system by STM spectroscopy.

Infrared spectroscopy has played a key role, for example in identifying the pseudogap and determining the spectral weight and transport lifetime of quasiparticles. There have been several noteworthy discoveries in recent years made by this technique. Polarization spectroscopy on underdoped materials has been used to measure the conductivity along and transverse to the stripe direction. The contrast ratio was found to be rather low, indicating that a picture of stripes as “rivers of charge” with highly 1D conduction is not correct. Another important finding is that the quasiparticle effective mass, as determined from the quasiparticle spectral weight per dopant atom, remains essentially constant even at doping levels very close to the Mott insulator. This adds support to one of the interesting emerging ideas regarding the appearance of the metallic state from the Mott insulator. This is the idea of the emergence of a segment of Fermi contour at the nodal position in momentum space. The properties of the quasiparticles at this segment, or Fermi arc, are remarkably similar to those of nodal quasiparticles that are seen at much higher doping levels. Finally, there has been a strong focus on the temperature dependence of the spectral weight, as quantified by the integral of the real part of the conductivity over frequency. Within certain assumptions, there is a quantitative connection between the spectral weight and the kinetic energy of the electrons in a band. There is growing evidence that the sign of the spectral weight changes that occur upon entering the superconducting state are consistent with kinetic energy lowering on the underdoped side of the phase diagram and opposite for the

overdoped side. For reference, a BCS-like transition driven by coupling to phonons is expected to occur with an increase in kinetic energy, i.e. consistent with overdoped but not underdoped compounds.

The cuprate superconductors present great opportunities for research using time-resolved probes. In such experiments Cooper pairs are broken by excitation with ultrashort optical pulses, creating a nonequilibrium population of quasiparticles. The lifetime of the quasiparticles is probed by measuring the transient change in reflectivity. In the last few years the dynamics of nonequilibrium quasiparticles have been considerably clarified. In underdoped cuprates the recombination lifetime diverges at low temperature. The long lifetime holds out the promise of probing the distribution of nonequilibrium quasiparticles in momentum space via time-resolved ARPES. Through this measurement it may be possible to see directly the scattering of quasiparticles in the Brillouin zone and thus be able to gain information about the momentum of the excitations that cause quasiparticles to scatter and perhaps to bind into Cooper pairs.

Resonant X-ray Scattering

One of the biggest questions in superconductivity research today is whether the ground state of the copper-oxides is homogeneous, or if it contains some intrinsic (either static or fluctuating) length scale. The strongest evidence for inhomogeneous ground states comes from Scanning Tunneling Spectroscopy (STS), however this technique is surface sensitive, works at fixed temperature, and can only be applied to materials that cleave.

A newer, alternative approach is resonant x-ray scattering (RXS). In RXS an x-ray photon is tuned to the threshold of an atomic core level, virtually exciting a core electron into the valence band. This electron then elastically de-excites, diffracting the photon in another direction. By adjusting the photon energy and sample angles, one can map out the momentum-resolved unoccupied density of states of the system. RXS currently has modest energy resolution compared to STS ($dE \sim 150$ meV), however it is bulk sensitive, can be done at variable temperature, and can be applied to materials that do not cleave. Some initial successes of RXS are the detection of a Wigner crystal in the copper-oxide spin ladder $Sr_{14}Cu_{24}O_{41}$ and valence band ordering in the static 'stripe' phase of $La_{2-x}Ba_xCuO_4$.

Future directions for RXS are the study of electronic ordering near buried interfaces in materials that have been nanopatterned. Improved scattered energy analysis will also allow for detailed study of 'fluctuating' order, and the use of high magnetic fields will allow the study of field-induced charge ordering in vortices.

STRATEGIC CHALLENGES IN COPPER OXIDE SUPERCONDUCTIVITY

The effect of physical structure on electronic structure.

In general, unconventional superconductors can be thought of as those wherein the superconducting order parameter (OP) does not reflect the symmetry of the underlying lattice. Most common are those in which the OP changes sign around the Fermi surface. The high-temperature cuprate superconductors, heavy-fermion superconductors and strontium ruthenate superconductors are all examples of unconventional superconductors. A unifying property of unconventional superconductors is that only a small change in the physical structure can produce a profound change in T_c . This is seen most clearly in the heavy-fermion and ruthenate superconductors, when a small amount of doping or crystalline disorder will substantially lower T_c , even to driving the system normal.

Within a traditional BCS picture, unconventional superconductors should be so sensitive to disorder, that any disorder, doping or strain in the lattice will substantially lower T_c , unlike the conventional superconductors. Therefore, not only is the crystalline order of the CuO_2 planes an important parameter to maintaining high- T_c , but the distance between the planes and the ions that sit in the lattice between the planes play a substantial role in determining the T_c . Furthermore, the number of CuO_2 planes within the unit cell, increasing from 1 to 2 to 3 in most cases, increases the T_c of the superconductor. This effect is likely due to the efficiency of charge transfer between planes and hole-doping into the planes, and can be somewhat described by bond-valence calculations. These issues are now at the forefront of research into the mechanism and T_c of cuprate superconductors.

x-ray diffraction. There has also been a lot of theoretical speculation concerning the ‘checkerboard’ state detected by STM studies, first on vortices in Bi-2212 and then on $\text{Ca}_{2-x}\text{Na}_x\text{CuO}_2\text{Cl}_2$. To maximize T_c , any competing states will need to be identified clearly and the form of the interactions leading to the competition will need to be understood.

These are crucial problems of atomic scale electronic structure to be resolved. The last of these appears to have been answered for a different but related system by specific heat studies of the heavy-fermion compound CeRhIn_5 , which by any standard is essentially free of extrinsic inhomogeneity. Applying pressure to this antiferromagnet induces first a phase of coexisting antiferromagnetism and superconductivity which is followed at higher pressures by a purely unconventional superconducting state. Adding a magnetic field to this state induces a magnetic transition that competes with but coexists with superconductivity. Although the nature of field-induced magnetism remains to be established, there are several similarities between what is found in this heavy-fermion material and both electron- and hole doped cuprates, suggesting a common origin from electronic correlations. The lower pressure phase, where Néel order sets in at a higher temperature than superconductivity, has been studied by NMR and neutron diffraction. These experiments are consistent with large-moment antiferromagnetic order coexisting homogeneously with unconventional superconductivity; however, how this can happen is an open question as is the influence of magnetic order on the superconducting order parameter and vice versa. Interestingly, NQR studies in this same pressure range indicate the appearance of a pseudogap above Néel order that evolves with pressure in much the same way that the pseudogap evolves with carrier doping in the cuprates.

Pairing Symmetry and Mechanisms

The competition between superconductivity and magnetism is endemic to a wide range of superconducting materials ranging from heavy fermions to cuprates. All of the unconventional superconductors (those that break symmetries beyond gauge symmetry, including the cuprates, UPt_3 , Sr_2RuO_4 , and likely CeCoIn_5 exhibit both magnetism and superconducting behavior. By contrast the highest temperature ‘conventional’ superconductivity in MgB_2 is generated by intense electron phonon interactions. The actual mechanism of pairing remains elusive in most if not all ‘unconventional’ superconductors. It seems clear that for the high- T_c , heavy-fermion and ruthenate superconductors, there must be some magnetic mechanism but there are also very significant electron-phonon interactions. A high-priority direction of research should be to find a definite conclusion on the primary source of interactions dominating the high T_c superconducting pairing mechanism. An understanding of the magnetic spectrum and the phononic spectrum as well as the interactions of the quasiparticles with both is essential to realizing the mechanism

General Role of Phases Competing with Superconductivity

In many superconducting compounds it is possible to vary the superconducting transition temperature, T_c , by adjusting a parameter such as composition or pressure. The maximum T_c generally occurs where a competing phase (typically magnetic) appears (or disappears). The competing phase might result from the same interactions that cause the superconductivity. Thus, experiments aim to map out phase diagrams, characterize the competing phases, and determine the degree of coexistence with superconductivity. Comparisons among different systems may reveal universal trends or distinguish unique behaviors.

Hole-doped cuprates. A characteristic phase diagram (temperature vs. mobile hole concentration in the CuO_2 planes) has been determined that applies to many cuprate families. At zero hole density, the material is a Mott insulator exhibiting antiferromagnetic order. Commensurate antiferromagnetic order is destroyed by 2% holes/Cu, and superconductivity appears at ~5% hole density, with maximum T_c at ~16%, and disappearance of superconductivity at ~25% hole density. In the lower density (under-doped) regime, the normal state has unusual properties typically labeled as the “pseudo-gap” phase. There have been theoretical predictions of various possible ordered or fluctuating states responsible for the pseudogap phenomena, but experiments have not yet yielded a unique answer. Charge inhomogeneity, in the form of stripe and/or checkerboard structures, has been observed in special samples. Such phases can also be induced about magnetic vortices in the superconducting state or about impurities in the CuO_2 planes such as Zn or Ni. Antiferromagnetic excitations have been detected throughout the superconducting regime; these become gapped, with enhanced intensity (“resonance” peak) above the gap, in the superconducting state. There is no consensus as to whether the antiferromagnetic excitations are associated with the parent Mott insulator phase or with Fermi-liquid-like excitations of the charge carriers.

Electron-doped cuprates. Commensurate antiferromagnetic order is observed up to the onset of superconductivity at a doped-electron density of ~14%. Antiferromagnetic excitations are also present, with a temperature-dependent gap, in the superconducting state.

Other transition-metal oxides. The system $\text{Ca}_{2-x}\text{Sr}_x\text{RuO}_4$ shows an interesting phase diagram as a function of isoelectronic chemical variation, going from an antiferromagnetic insulator at $x = 0$ to a nearly-magnetic superconductor at $x = 2$. The phase diagram of $\text{Na}_x\text{CoO}_2 \cdot n\text{H}_2\text{O}$ shows various magnetic and modulated phases, as well as superconductivity.

Heavy-fermion compounds. Heavy-fermion compounds tend to exhibit a close connection between superconducting and magnetic (especially antiferromagnetic) phases. Strong electronic correlations result from the presence of elements with 4f or 5f electrons. One system of recent interest is CeMIn_5 , which is superconducting for $M = \text{Co}$ or Ir , but antiferromagnetic for $M = \text{Rh}$. This has led to the discovery of superconductivity in PuCoGa_5 and PuRhGa_5 with $T_c = 18.5$ and 9.5 K, respectively. A correlation has been observed between T_c and the magnetic energy scale. That correlation has been extended to include the cuprates.

Organics. A number of quasi-1D and 2D organic conductors (especially the Bechgaard salts) exhibit complicated phase diagrams as a function of pressure and composition that include superconductivity, antiferromagnetism, spin-density waves, spin-Peierls states, and charge order. There are strong empirical correlations between the superconductivity and magnetism.

Experimental technique for phase competition. The phase boundaries in a given phase diagram are typically mapped out with thermodynamic and transport measurements, including specific heat, magnetic susceptibility, resistivity, Hall effect, thermal conductivity, thermoelectric effect, and Nernst effect. Such measurements also provide information on the relationship between phases on both sides of a phase boundary. Magnetic ordering can be detected by nuclear magnetic resonance and muon spin rotation spectroscopy. The spatial correlations of magnetic moments can be probed by neutron diffraction and, in some cases, resonant x-ray diffraction. Dynamic magnetic correlations are measured with inelastic neutron scattering and 2-magnon Raman scattering. Charge modulations can be probed with neutron diffraction, electron diffraction, and x-ray diffraction, especially including resonant soft-x-ray diffraction.

FURTHER READING: SUPERCONDUCTIVITY PHENOMENA

1. D.A. Bonn, "Are high-temperature superconductors exotic?" *Nature Physics* **2**, 159 (2006).
2. J. Orenstein, A.J. Millis, "Advances in the Physics of High-Temperature Superconductivity," *Science* **288**, 468 (2000).
3. John M. Tranquada, Neutron Scattering Studies of Antiferromagnetic Correlations in Cuprates to appear as a chapter in "Treatise of High Temperature Superconductivity" by J. Robert Schrieffer, cond-mat/**0512115**.
4. P.A. Lee, N. Nagaosa, and X.-G. Wen, "Doping a Mott insulator: Physics of high-temperature superconductivity," *Rev. Mod. Phys.* **78**, 17-85 (2006).
5. E. Demler, W. Hanke, and S.-C. Zhang, " $SO(5)$ theory of antiferromagnetism and superconductivity," *Rev. Mod. Phys.* **76**, 909-974 (2004).
6. S. Sachdev, "Order and quantum phase transitions in the cuprate superconductors," *Rev. Mod. Phys.* **75**, 913-932 (2003).
7. Damascelli, Z. Hussain, and Z.-X. Shen, "Angle-resolved photoemission studies of the cuprate superconductors," *Rev. Mod. Phys.* **75**, 473-541 (2003).
8. C. Tsuei and J.R. Kirtley, "Pairing symmetry in cuprate superconductors," *Rev. Mod. Phys.* **72**, 969-1016 (2000).

9. T. Timusk and B. Statt, "The pseudogap in high-temperature superconductors: an experimental survey," *Reports on Progress in Physics* **62**, 61, (1999).
10. M. Imada, A. Fujimori, and Y. Tokura, "Metal-insulator transitions," *Rev. Mod. Phys.* **70**, 1039-1263 (1998).
11. C.H. Pennington and V.A. Stenger, "Nuclear magnetic resonance of C_{60} and fulleride superconductors," *Rev. Mod. Phys.* **68**, 855-910 (1996)
12. D.J. Van Harlingen, "Phase-sensitive tests of the symmetry of the pairing state in the high-temperature superconductors—Evidence for $d_{x^2-y^2}$ symmetry," *Rev. Mod. Phys.* **67**, 515-535 (1995)

Vortex Phenomena

EQUILIBRIUM VORTEX PROPERTIES

The vortex lattice. The basic magnetic field - temperature (H-T) phase diagram of a type II superconductor (SC) is defined by two lines, the lower critical field $H_{c1}(T)$ and the upper critical field $H_{c2}(T)$. The region between these two lines is the *mixed state*, which is characterized by the penetration of magnetic field in quantized units of magnetic flux called *vortices*. A vortex is a tube consisting of a non superconducting core whose radius is of the order of the coherence length ξ , surrounded by circulating supercurrents spreading over a radius of the order of the penetration depth λ and generating an axial magnetic field carrying a total flux of one flux quantum $\Phi_0 = h/2e$. Vortices have a self-energy per unit length ε_l which arises from both the loss of condensation energy at the core and the kinetic energy of the supercurrents. Vortex-vortex interactions are repulsive, and in equilibrium they form a triangular array known as the *Abrikosov lattice*, with lattice parameter $a \sim (\Phi_0/B)^{1/2}$, where B is the magnetic induction. In some unusual cases such as borocarbides, vortices arrange into rhombic or square lattices due to nonlocal electrodynamics effects and an anisotropic superconducting gap. Non-hexagonal flux line lattices also occur in V_3Si and ruthenates.

Anisotropic superconductors. The most common and technologically relevant is the case of layered materials, where the superconducting coupling is weaker along the c-axis as compared to the basal plane. This group includes all high temperature superconducting (HTS) cuprates, as well as MgB_2 and some conventional low temperature superconductors (LTS) such as $NbSe_2$. These materials are characterized by an electronic mass anisotropy γ , such that ξ_c along the c-axis is shorter than in the basal plane, $\xi_c = \xi_{ab}/\gamma$; the inverse is true for the penetration depth, where $\lambda_c = \lambda_{ab} * \gamma$. Within the basal plane, the SC properties are isotropic in hexagonal compounds such as MgB_2 and $NbSe_2$ and in the tetragonal HTS, and almost isotropic in the slightly orthorhombic $YBa_2Cu_3O_7$ (YBCO) family. The quantities H_{c1} , H_{c2} and ε_l depend on the orientation of \mathbf{H} with respect to the crystallographic axes, and the Abrikosov lattice is non-equilateral except for $\mathbf{H} // c$. The vortex phenomenology is more complex, and in extremely anisotropic SC such as Bi-2212 and Bi-2223 ($\gamma > 100$) the flux lattice for orientations other than $\mathbf{H} // ab$ is better described as stacks of *pancake vortices* lying in the Cu-O planes, which interact via Josephson coupling, while for $\mathbf{H} // ab$ a lattice of *Josephson vortices* develops.

VORTEX PINNING

Effect of electric currents, flux flow. An electric current density J applied to a SC in the mixed state exerts a Lorentz-like force on the vortices that is perpendicular to both \mathbf{J} and \mathbf{H} . In a perfectly homogeneous SC this induces a flux lattice motion at a constant velocity perpendicular to \mathbf{J} , which in turn generates an electric field anti-parallel to \mathbf{J} and proportional to it. Thus in this *flux flow* regime, the SC exhibits an ohmic response with a flux flow resistivity $\rho_{ff} \sim \rho_n * (H/H_{c2})$, where ρ_n is the normal state resistivity. Consequently, vortex motion creates a dissipative regime in which the technologically most relevant property of the SC ($\rho = 0$), is negated.

Pinning energy, pinning force and critical current. To retain the capability to carry electric currents without dissipation, the vortex motion in a SC must be precluded. This occurs when the translational symmetry in the material is broken by structural defects where the superconductivity is suppressed or at least weakened. When a portion of a vortex core traverses one of those defects, the condensation energy cost required to create the core is reduced, and the vortex self-energy decreases. The defect thus acts as an attractive potential for the vortex. The difference in self-energy for a vortex located inside and outside the defect is the *pinning energy* u_p of the defect, which can be roughly estimated as the condensation energy per unit volume ($H_c^2 / 8\pi$) times the volume of core that is pinned. If an applied current tends to displace the vortex from a defect, a restoring force develops and the vortex remains pinned. The maximum possible value of the restoring force, given by the maximum gradient of the position dependent vortex energy, is the *pinning force* f_p of the defect. As ε_l cannot change over distances shorter than $\sim \xi$ regardless of the sharpness of the defect-matrix interface, $f_p \leq u_p / \xi$. The *critical current density* J_c is the value of J that produces a force on a vortex enough to overcome the pinning force of all the defects trapping it along its length, and consequently is able to move it. The value of J_c (which decreases with temperature because u_p decreases and ξ increases) is the most important performance parameter in a SC wire.

Types of pinning centers. The relation between J_c at given T-H conditions and the defects in the material is very complex. Basically, the ideal size of a spherical pinning center is $\sim \xi$; smaller defects have too small u_p , larger ones reduce the cross section of the SC matrix without increasing f_p . A higher density of pinning centers is clearly convenient, but in order to occupy a large number of randomly distributed defects, the flux lines must tilt and bend, which has a cost in terms of increased elastic energy; thus the effective pinning force density grows sublinearly with the defect density. The limit of a dense distribution of defects on the scale of ξ is described by the collective pinning theory, which shows that in that case only the statistical fluctuations in the energy landscape produce pinning, which tends to be weak. More effective pinning can be produced by *correlated disorder*, such as parallel non-superconducting rods of radius $\sim \xi$. These columnar defects can confine the whole length of a vortex core, thus optimizing u_p , without paying a cost in increased elastic energy. A similar advantage can be obtained with parallel planar defects, provided that they are oriented in such a way that the flow of current is not interrupted. The pinning produced by correlated disorder is anisotropic, being strongest for vortices parallel to the defects. For any type of pinning (random or correlated), the vortex-vortex interactions must be considered as soon as the distance between flux lines is smaller than $\sim \lambda$ (which in practice occurs in all technologically relevant cases), and the force balance must be calculated between the current acting over the whole vortex array and all the pinning centers. In anisotropic materials such as HTS, the pinning properties (and consequently J_c) depend on the orientation of \mathbf{H} as well as its magnitude.

Limits to J_c - depairing current. The optimization of J_c in SC wires has large technological importance, and the progress made in recent years in HTS wires has been very significant. A key question that must be answered from a fundamental understanding is: how much further can we go? To put the values in perspective, it is useful to compare J_c at $H=0$ and low T to the *depairing current density* J_0 , at which the kinetic energy of a Cooper pair equals the gap energy and superconductivity is suppressed. In single crystals of borocarbides like $\text{YNi}_2\text{B}_2\text{C}$ or $\text{LuNi}_2\text{B}_2\text{C}$, which are deep inside the clean limit, $J_c/J_0 \sim 10^{-6}$. In LTS wires such as NbTi and Nb_3Sn , whose pinning properties have been improved over decades of research, it can be as high as $J_c/J_0 \sim 0.1$ to 0.2 . Remarkably, the same values are already obtained in YBCO very thin films and coated conductors. No fundamental reason precluding higher J_c/J_0 ratios is presently known. Simple theoretical estimates for optimum columnar defects give $J_c/J_0 \sim 1$. This is an important open topic for fundamental investigation.

Thermal fluctuations have a major impact on vortex dynamics when the energy scale of the typical barrier between vortex configurations, $(H_c^2/8\pi)\xi^3$, is of the order of $k_B T$. In LTS the influence of fluctuations is almost negligible, while in HTS it is orders of magnitude more important, due mainly to their very short ξ , and to a lesser extent to the higher T . The most apparent consequence of the large thermal fluctuations in HTS is the existence of an irreversibility line $H_{\text{irr}}(T)$, above which the vortex response is reversible and $J_c=0$. That region may occupy a big portion of the H - T plane [i.e. $H_{\text{irr}}(T)$ may be much smaller than $H_{c2}(T)$] and it is useless for wire applications. In the reversible region the vortex matter is in a liquid phase, separated from the solid phase by a thermodynamic first or second order melting transition. The solid vortex phases may be glassy rather than crystalline. Depending on the material anisotropy, field orientation, and types of disorder, a variety of liquid and glassy phases of different dimensionality are observed. Since the discovery of HTS, the study of these liquid and glassy vortex phases has attracted enormous attention and developed into a novel fundamental field in statistical mechanics and soft matter physics (see section on Theory for Applications).

Flux creep. Another manifestation of thermal fluctuations is flux creep, which produces a slow time decay of the “persistent” J circulating in a closed SC circuit. The decay is approximately logarithmic in time and can be characterized by the creep rate $S=d\ln(J)/d\ln(t)$. In commercial NbTi or Nb_3Sn wires the creep is very small ($S \sim 10^{-4}$), but in HTS cuprates it is much larger, typically $\sim 0.01 - 0.02$ or more. In transport measurements, creep leads to “power law” current density vs. electric field, $E = E_0(J/J_c)^N$, where $N \sim S^{-1}$. This implies undesired dissipation even for J lower than the “ideal” J_c that would exist in the absence of thermal fluctuations, and this problem is particularly significant in HTS wires.

VORTEX PINNING AND DYNAMICS IN SUPERCONDUCTING WIRES

Existing SC wires can be divided in LTS and HTS cuprates. The HTS wires are the only ones that can be used at liquid N_2 temperatures, and have H_{c2} values (well above 100T) that far exceed those of LTS. The reason for this is

the short ξ of HTS. Unfortunately, this short ξ , plus the large anisotropy, also generate the *weak-links* problem of the HTS: at the boundary between two grains of different crystalline orientation a strong local depression of the order parameter occurs, and consequently J_c drops drastically as compared to the bulk or *intragrain* J_c . In contrast, due to the longer ξ of LTS the current can flow across the grain boundaries without impediment, thus allowing the fabrication of polycrystalline wires with high J_c . In fact, grain boundaries are good pinning centers in anisotropic LTS.

LOW TEMPERATURE SUPERCONDUCTORS

Nb-based SC

Wires of these materials (particularly the ductile Nb-Ti alloy and the brittle compound Nb₃Sn) have been commercially produced for decades. Their pinning, thermal and mechanical properties have been extensively explored and optimized, and their whole vortex phase diagram is known. As mentioned above, they have large J_c/J_0 and negligible influence of thermal fluctuations, thus S is very small and $H_{irr}(T) \approx H_{c2}(T)$ (no vortex liquid phases).

MgB₂

Advantages. With its superconductivity just discovered in 2001, this compound has been the focus of large scientific and technological interest. It possesses a combination of favorable characteristics, such as the chemical simplicity, the highest T_c among known binary SC (~ 39 K), the low cost of the raw materials, and the absence of the weak-links problem at grain boundaries. This last feature allows fabrication of polycrystalline wires with very good performance using simple and mature powder-in-tube (PIT) technology.

H_{c2} enhancement. The main disadvantage of early MgB₂ samples was their low H_{c2} . We now know that those samples were in the superconducting clean limit, and that H_{c2} can be significantly increased by (selectively) driving it to the dirty limit through chemical doping. Carbon doping can increase $H_{c2}(T=0)$ up to more than 40 T in bulk samples, and up to near 60 T (for H//ab) in oriented thin films. The influence of doping on H_{c2} is more complex in MgB₂ than in standard LTS because MgB₂ is a two-gap superconductor. The functional dependence of $H_{c2}(T)$ is unconventional and depends on the doping type and level, so γ is temperature-dependent. At low T , the H_{c2} anisotropy decreases from $\gamma \sim 5-6$ in clean samples to $\gamma \sim 1.5$.

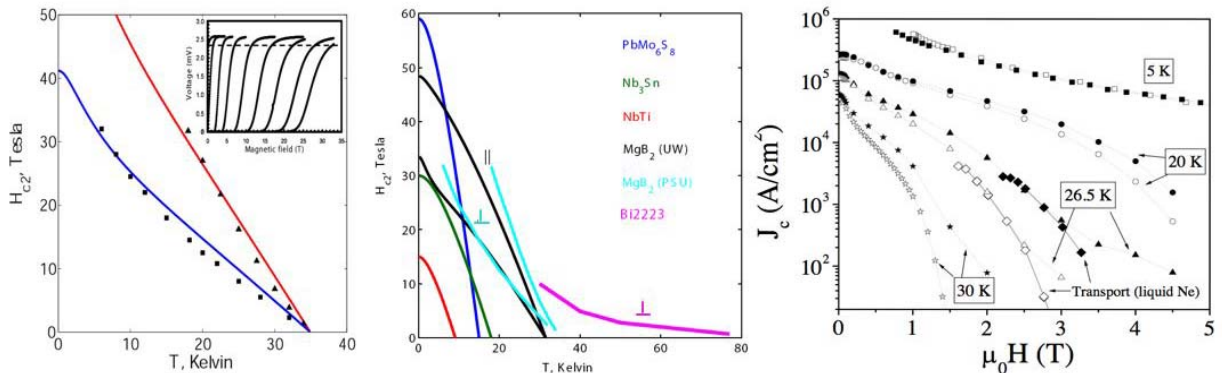

Figure 11 Upper critical field and critical current measurements in MgB₂. **Left panel:** $H_{c2}(T)$ for H//ab (triangles) and H//c (squares) for a C-doped MgB₂ grown by hybrid physical-chemical vapor deposition (HPCVD). The solid lines are fits to a theory of dirty two-gap superconductivity (Braccini et al.). **Central panel:** $H_{c2}(T)$ curves for useful superconductors, including MgB₂ films from Penn State and Univ. of Wisconsin. **Right panel:** J_c as a function of H for H//c at several temperatures for un-doped MgB₂ powder-in-tube (PIT) wires suitable for magnet applications. Open symbols: wire annealed at ambient pressure. Full symbols: wire annealed using hot isostatic pressing (HIP).

Vortex pinning in MgB_2 arises from dislocations at grain boundaries and sub-grain interfaces, and from randomly distributed small MgO and $\text{Mg}(\text{B}_2\text{O}_7)$ precipitates. It can be further enhanced by mechanical methods such as hot isostatic pressing (HIP) and by addition of non-superconducting particles such as SiC . It is interesting that doping with SiC produces both higher H_{c2} and enhanced pinning. MgB_2 wires can now be fabricated with J_c higher than Nb-based wires at any T and H, and their performance is good enough to target applications in the ~ 20 K range.

HIGH TEMPERATURE SUPERCONDUCTORS

BSCCO

This is the so-called “first generation” of HTS wires. PIT tapes of Bi-2223 are now produced at industrial scale (see section on Applications). Due to its huge anisotropy ($\gamma > 100$), the weak links problem is severe, and J_c for $J//c$ is very small. The large γ means that the $H_{ir}(T)$ is very low. Applications that require wires at substantial magnetic fields (motors, generators, etc.) are only possible at temperatures below 40 K, although cables can be operated at liquid N2 temperatures.

Connectivity in BSCCO wires. Current transfer in polycrystalline BSCCO conductors is apparently aided by the mesostructure or colony structure of the BSCCO materials although in a manner that is not fully understood at this point. The colony structure is a stack of platelike grains of very large aspect ratio (> 1000) misoriented relative to one another by twist boundaries about a common c-axis. The attainment of partial texture (relative to the c-axis) in the processing of PIT tapes improves the current density, especially in Bi-2223 tapes. However, the example exists of Bi-2212 multifilamentary *round* wires that have a fiber texture (c-axis parallel to the radial direction). At 4K, these wires now have J_c above 0.5 MA/cm². Although these J_c values are almost two orders of magnitude lower than the best coated conductors at 4K, the much higher fill factors of the Bi-2212 round wires allow for technologically and economically useful levels of critical currents. No YBCO round wire with fiber texture or tape with uniaxial texture would carry currents comparable to similar BSCCO conductors. The BSCCO conductors apparently have a much different dependence on grain boundary misorientations although a Dimos-like criterion for its description has not been fully defined.

Flux Pinning in BSCCO. The sources of pinning that determine the intragrain J_c in Bi-2223 and Bi-2212 wires are also poorly understood at present. The J_c 's at low temperatures have been measured up to very high fields (~ 45 T), but the knowledge of more fundamental aspects such as the full $H_{c2}(T)$ and $H_{ir}(T)$ curves, or the vortex phases at high fields, is incomplete.

Coated conductors

Solution of the weak-links problem. These “second generation” HTS wires, based on YBCO films and known as coated conductors (CC), are presently the focus of the main effort in the development of HTS wires. The reason is that, in principle, they solve the main disadvantages of the first generation. They have a much higher $H_{ir}(T)$, potentially they can be made at a significantly lower cost, and they allow to solve (rather than circumvent) the weak links problem. The approach consists of depositing *biaxially textured* YBCO, i.e., the individual grains must be oriented not only along the c-axis but also in the ab planes. This condition is easy to achieve in a thin film deposited on a single crystalline substrate, but in order to produce long lengths of useful superconductor, it is necessary to induce biaxial texture in a YBCO layer deposited on top of a polycrystalline, inexpensive, commercially available metallic tape. More precisely, when the in-plane misalignment between adjacent YBCO grains exceeds 2° - 3° , the grain boundary impedes super-current flow, reducing J_c , and when it exceeds 4° - 5° , the boundary behaves as a weak-link. The fabrication of these “single crystals by the kilometer” is one of the most difficult and fascinating current challenges in materials science and technology. The science and technology of producing best-in-class coated conductors is discussed in a subsequent section.

Methods to produce the biaxial texture in CC. One way to produce CC is through the Rolling Assisted Biaxial Textured (RABiTs) method. The starting point is a polycrystalline Ni or Ni-alloy which is rolled and heat treated in a manner that imparts cubic texture to the final tape. Metal-oxide buffer layers and the YBCO film are then epitaxially deposited on it. An alternative method is the Ion Beam Assisted Deposition (IBAD). In this case, a

template material (such as YSZ or MgO) is deposited on top of a polycrystalline tape (such as stainless steel or Hastelloy), while a collimated ion beam (typically ~ 750 eV Ar) concurrently bombards the film, which gradually acquires biaxial (cubic) texture, thus becoming the template for subsequent buffer and YBCO layers. In reality, the architecture of the CC is more complex, as several additional layers need to be intercalated to act as seed layers, diffusion barriers, etc.

Methods to grow the YBCO film. The YBCO film can be deposited on top of the textured buffer by several processes. The methods with potential for industrial scale production can be generally divided into two categories, namely *in-situ* such as pulsed laser deposition (PLD), metal organic chemical vapor deposition (MOCVD), liquid phase epitaxy (LPE), and hybrid liquid phase epitaxy (HLPE), and *ex-situ*, where a precursor layer is deposited by scalable techniques such as metal organic deposition (MOD), or physical vapor phase deposition (PVD). It has been found that YBCO films with high self-field J_c can be obtained from different deposition processes that produce decidedly different microstructures. The J_c is limited by the connectivity, which is directly tied the degree of bi-axial texture obtained in the YBCO film. Yet, the differences in the microstructure directly affect the properties of the superconductors in applied fields. Hence, connectivity and flux pinning are independently controllable properties in the development of coated conductors. Issues affecting connectivity and flux pinning in YBCO films are still intense areas of study. Presently, YBCO films grown by PLD on IBAD MgO can be made with such a good in-plane texture ($\text{FWHM} < 3^\circ$) that the grain boundary limitation completely disappears. In contrast, even in the best available YBCO films grown by *ex-situ* methods on RABiTs, the in-plane texture is worse ($\text{FWHM} \sim 5^\circ$) so the grain boundary limitation persists, however in state-of-the-art *ex-situ* CC the J_c deterioration is not dramatic and occurs only at low H. Recent investigations have highlighted that apart from the grain misalignment, also the grain boundary geometry plays a role in the current transport. This geometry may deviate significantly from a flat, planar interface, depending on the YBCO growth mechanism. It is believed that such “meandering” GBs enable larger super-current transport than “flat” boundaries between grains of the same misalignment. This topic is still under extensive examination.

Thickness dependence of J_c . The best quality YBCO films available today exhibit a J_c at *self-field* that decreases with film thickness (figure 12). For instance, films ~ 0.2 μm thick can have $J_c(77\text{K}, \text{sf})$ as high as ~ 7 MA/cm^2 , but in films thicker than ~ 3 μm it decreases to ~ 2 MA/cm^2 or less. The qualitative behavior appears to be universal, regardless of the deposition method and it occurs for both for films on single crystal substrates and on metallic templates (RABiTs or IBAD), but the quantitative details are processing-dependent. This has been a central problem in CC pinning research for several years, and various interpretations have been proposed. Recent results in PLD suggest the existence of two contributions to J_c , one a thickness-independent bulk-like contribution and the other arising from defect formation close to the substrate interface. Hence a drop-off in J_c occurs for fairly thin YBCO ($d < 1$ μm) and J_c stabilizes at the “bulk” level for thicker coatings. *Ex situ* films may have the capacity to retain a higher bulk J_c contribution, however, the details of this behavior remain to be elucidated.

Multilayers. An elegant solution to the thickness dependence problem in PLD coatings is the synthesis of multi-layer structures, “breaking up” the thick YBCO layer by inserted thin layers ($\sim 20\text{nm}$) of non-superconducting material such as CeO_2 or YSZ. Short samples of these multilayers have the highest critical currents (per unit width) I_c presently available in CC. At 75 K and self-field, values up to $I_c \sim 1400$ A/cm have been demonstrated in 6-units stacks of total thickness ~ 3.5 μm . This corresponds to $J_c \sim 4$ MA/cm^2 , well above YBCO monolayers of the same thickness (figure 12). This recently developed method has not yet been demonstrated in long lengths of continuously produced CC. According to present understanding, multilayering cannot be implemented in *ex-situ* processes.

In-field performance. Most power applications of HTS (cables being the most important exception) will require CC operating in fields of a few Tesla. The J_c (or I_c) must be optimized for application-specific T-H- Θ operating conditions (here Θ is the angle between \mathbf{H} and the c-axis). The origin of the very high J_c in YBCO films (orders of magnitude higher than in single crystals) has been a puzzle for a long time. Although very significant progress in the understanding of this issue has been made in recent years, the topic remains highly active and controversial. Basically, effective defects for pinning must be of atomic or nanometric size (due to the short ξ) and be present in large density. The analysis of $J_c(\Theta)$ shows three main types of pinning sources. Random defects generate a smooth angular dependence with minimum J_c for $\Theta=0^\circ$ and maximum for $\Theta=90^\circ$. Correlated disorder along the c-axis (such as dislocations) produce a peak in $J_c(\Theta)$ centered at $\Theta=0^\circ$, while correlated pinning along the ab-planes (such as stacking faults, intergrowths, or the intrinsic pinning due to the layered atomic structure) produce an additional peak in $J_c(\Theta)$ centered at $\Theta=90^\circ$.

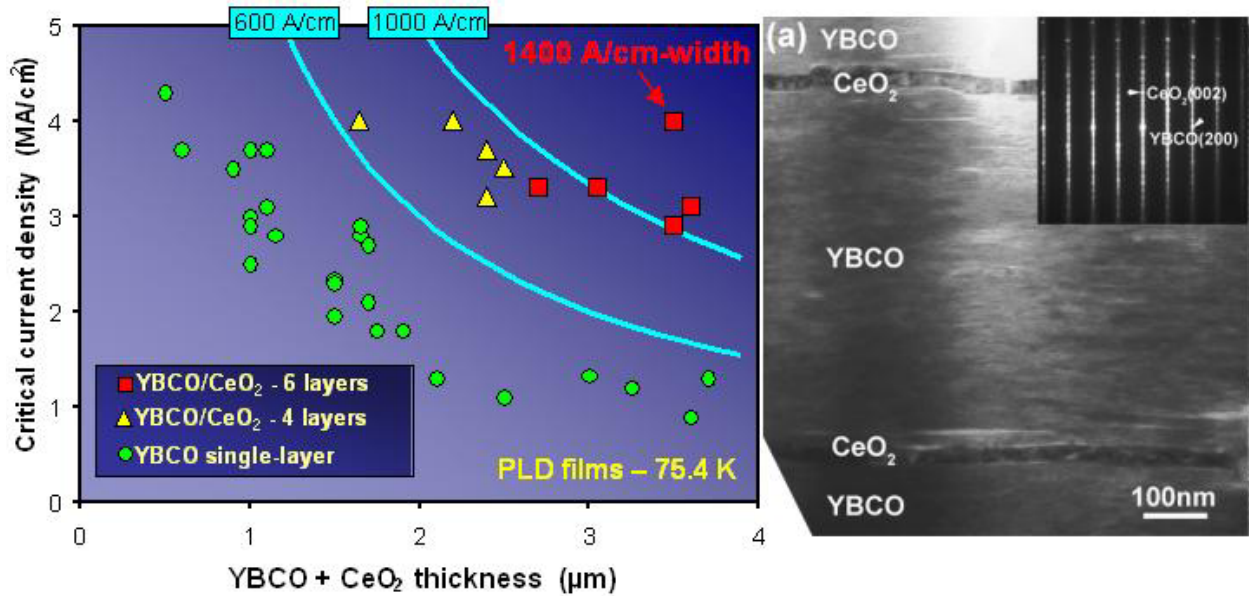

Figure 12 Relationships between critical current and microstructure. **Left panel:** The green circles show the J_c at 75K and self-field, for YBCO films grown by PLD on IBAD MgO templates. They exhibit the usual decay of J_c with thickness, common to all YBCO film deposition methods (in-situ and ex-situ). A solution to the thickness dependence problem is to separate multiple YBCO layers with thin non-superconducting interlayers (such as CeO_2 or Y_2O_3), as shown in the figure for several $(\text{YBCO}/\text{CeO}_2)_N$ multilayers (yellow triangles $N=4$, red squares $N=6$). The record values of I_c per unit width in CC ($\sim 1400\text{A}/\text{cm}$ at 75K) have been achieved by this method. **Right panel:** TEM image of a YBCO/ CeO_2 multilayer (YBCO layer thickness $\sim 0.6 \mu\text{m}$, CeO_2 layer thickness $\sim 30 \text{nm}$).

Pinning in in-situ and ex-situ CC. The relative importance of the various sources of pinning mentioned above differ in in-situ and ex-situ YBCO films due to their different microstructures and growth conditions.

- The columnar growth in PLD produces a proliferation of dislocations and consequently a prominent c-axis peak in $J_c(\Theta)$. There is also a significant contribution from random defects, whose angular dependence can be described by an anisotropic scaling model. The additional ab-plane peak is sharp and not very prominent (as compared to ex-situ films) and arises in part from intrinsic pinning.
- The laminar growth in MOD or other ex-situ methods results in almost no dislocations and very small c-axis peak, while the high density of planar defects (intergrowths) parallel to the ab-planes generates a very large ab-plane peak. The contribution from random disorder is also smaller than in in-situ films.

Processing methods for pinning improvement. Several methods to improve pinning in CC have been successfully demonstrated. They can be divided in two groups:

i) Introduction of defects in the bulk of the superconductor

- **Rare Earths substitutions.** Films with stoichiometric combinations of two rare earths (RE), such as $\text{Dy}_{1/3}\text{Ho}_{2/3}\text{Ba}_2\text{Cu}_3\text{O}_7$ or $\text{Y}_{1-x}\text{Sm}_x\text{Ba}_2\text{Cu}_3\text{O}_7$ have better in-field performance than YBCO. Measurements of $J_c(\Theta)$ indicate that the additional pinning is predominantly random, consistent with disorder at atomic scale. More recently, it was shown that combinations of three RE (which had previously proven successful in bulk samples) also improve J_c in films, possibly due to spatial modulation in the RE content.

- **Nanoparticles.** To be effective vortex pinners, non-superconducting particles added to the YBCO matrix must be nano-sized. BaZrO₃ (BZO) nanoparticles randomly distributed in PLD YBCO produce large improvement of the in-field performance. The effect is somewhat indirect: the nanoparticles induce dislocations that produce the additional c-axis correlated pinning. A huge c-axis peak appears, concomitant with a much-reduced deterioration of J_c with increasing field. Generally, J_c(H) for **H**//c in H-T ranges useful for wire applications follows a power law falloff J_c∝H^{-α}. From α~0.55 to 0.6 typical of “undoped” PLD YBCO films, BZO nanoparticles can improve it to α~0.2.

Different deposition conditions result in BZO *nanorods* and/or (roughly) aligned stacks of BZO nanodisks, which are very effective columnar defects and also produce uniaxial pinning. This “self-assembly” is very attractive; it expands the possibilities to “tune” the density of correlated defects, and maybe it can be used to produce periodic pinning.

Another very successful nanoengineering of pinning centers is the fabrication of multilayers of YBCO and sub-monolayers of Y₂BaCuO₅ (the “211” phase). In this case the pinning structures are correlated along the ab-planes and are quasi-periodic.

Nanoparticles can also be incorporated in ex-situ YBCO, for instance by non-stoichiometric addition of rare earths, YRE_xBa₂Cu₃O₇, where RE=Y, Dy, Er, Ho. This produces 10-100 nm sized secondary phase precipitates, which provide strong pinning improvement over all field orientations, leading to reduced dependencies of J_c with angle. Due to the laminar structure of the MOD films, no dislocations are induced. The particles also decrease the density of intergrowths, thus reducing the ab-plane peak.

ii) Enhancing pinning from interfaces

The buffer layer immediately underneath the YBCO affects the pinning properties due to the generation of interface defects. Interface-related pinning can be enhanced in several ways:

- **Manipulating buffer surface roughness.** For instance, by changing the STO buffer deposition conditions it is possible to generate epitaxial STO outgrows, which induce dislocations in the YBCO that propagate through its whole thickness and act as pinning centers. Irradiation has also been used to damage the buffer surface.
- **Depositing nanodots on the buffer,** such as Y₂O₃, which may act as seeds for defect formation in the YBCO coating, providing added pinning for fields applied along the c-axis primarily but also in non-perpendicular orientations (depending on the growth mechanism).
- **Tuning buffer/YBCO lattice mismatch.** This depends on the buffer composition.
- **Miscut or tilt of buffer.** This also induces defects in the YBCO that propagate through its whole thickness and act as correlated pinning not necessarily parallel to the c-axis. It can be used as a method for engineering the angular dependence.
- **Multilayers** such as YBCO/CeO₂, already discussed.

Some open issues: The propagation of various types of interface defects into the bulk YBCO is poorly understood. It depends on the YBCO growth method (i.e., structure). What determines the propagation distance? Which interface defects in particular are responsible for the enhanced pinning? Which is the best interlayer material in multilayers and why? What is the importance of the electrical properties of the interlayers? Big question: can multilayers be grown at industrial scales by ex-situ methods such as MOD?

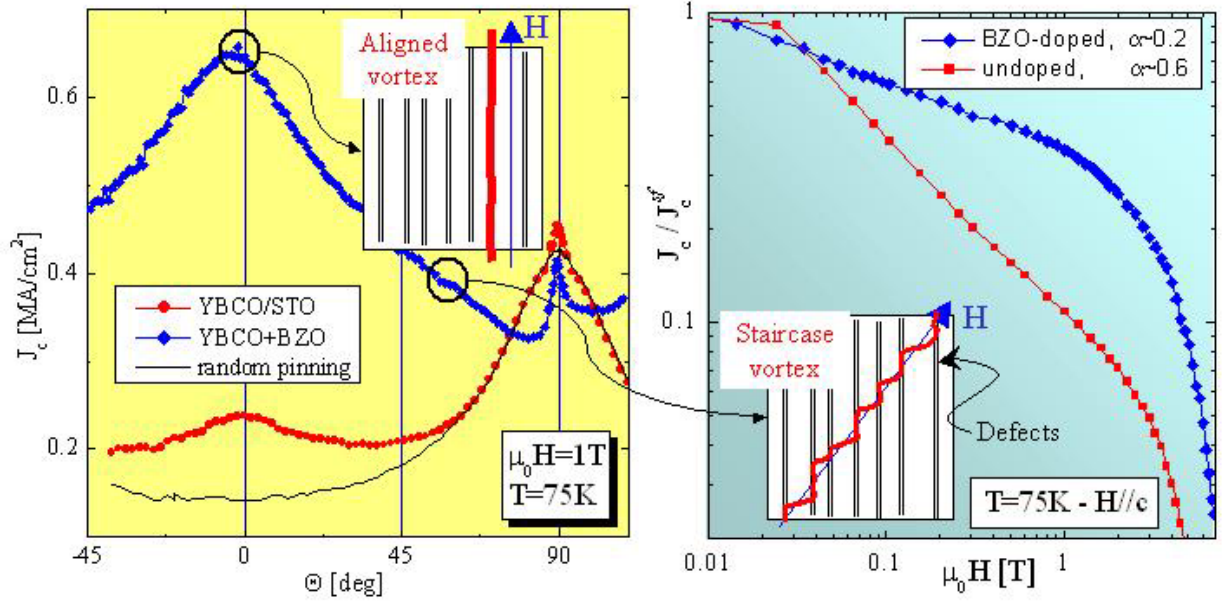

Figure 13 Angular-dependent critical field as a diagnostic of pinning mechanisms. **Left panel:** J_c at 75K and $\mu_0 H=1T$ for YBCO films grown by PLD, as a function of the angle Θ between H and c-axis. The undoped film (red circles) exemplifies the usual three contributions to vortex pinning, (i) random point-like disorder (black line), (ii) additional broad c-axis peak arising from correlated pinning along the c-axis, mostly dislocations associated to the columnar growth of PLD films, and (iii) additional narrow ab-plane peak arising from ab-correlated and intrinsic pinning. Engineering of pinning structures by addition of BaZrO₃ nanoparticles results in a strongly improved J_c (blue diamonds), mainly due to additional correlated pinning from c-axis dislocations growing from the nanoparticles. The sketches show the structure of the pinned vortices for $H//c$ and for a tilted orientation. **Right panel:** The deterioration of J_c with field, which is described by the power law $J_c \propto H^{-\alpha}$, is strongly reduced by the BZO additions, with α decreasing from ~ 0.6 to ~ 0.2 (for $H//c$).

Interplay of YBCO microstructure and added defects. The pinning enhancement produced by a given type of added defects depends on the microstructure of the YBCO film, which in turn is determined by the fabrication conditions. A clear example is the different effect of nanoparticles in columnar PLD and laminar MOD.

Addition of more than one type of defects. Various combinations of the pinning enhancement methods described above have been tried, with no particular success so far. The main problem is that *pinning is not additive*. We know very little about the combined effects of more than one type of pinning centers. This applies both to the combination of pinning enhancement methods (e.g. nanoparticles+multilayers) and to the interaction between added defects and the growth-method dependent microstructure of the YBCO described above. In many cases the combination of defects produces some negative effects. Examples: columnar defects produced by irradiation increase J_c in one orientation but deteriorates intrinsic pinning; RE oxide additions to MOD YBCO increases J_c for $H//c$ but reduces it for $H//ab$ because it reduces the density of planar defects parallel to the ab-planes.

This is a very important problem, and potentially a lot of progress can be made with a coordinated effort. We need systematic experimental studies in various types of CC, studies in model systems that may have no direct technological interest, numerical simulations, and theory. Once combinations of defects are understood, we could develop application-specific engineering of pinning, optimizing J_c at the desired field-angle-temperature conditions.

Pinning in CC at very high fields. CC are excellent candidates for very high field superconducting magnets operating in liquid He. A couple of studies of J_c at 4K for $H//c$ and $H//ab$ up to 45T are available. Measurements at higher (pulsed) fields have not been reported. The angular dependence at high H is unknown. The effects of the various pinning enhancement methods described above have not been explored at high fields. Due to the large vortex density, pinning is expected to be dominated by dense point-like random disorder.

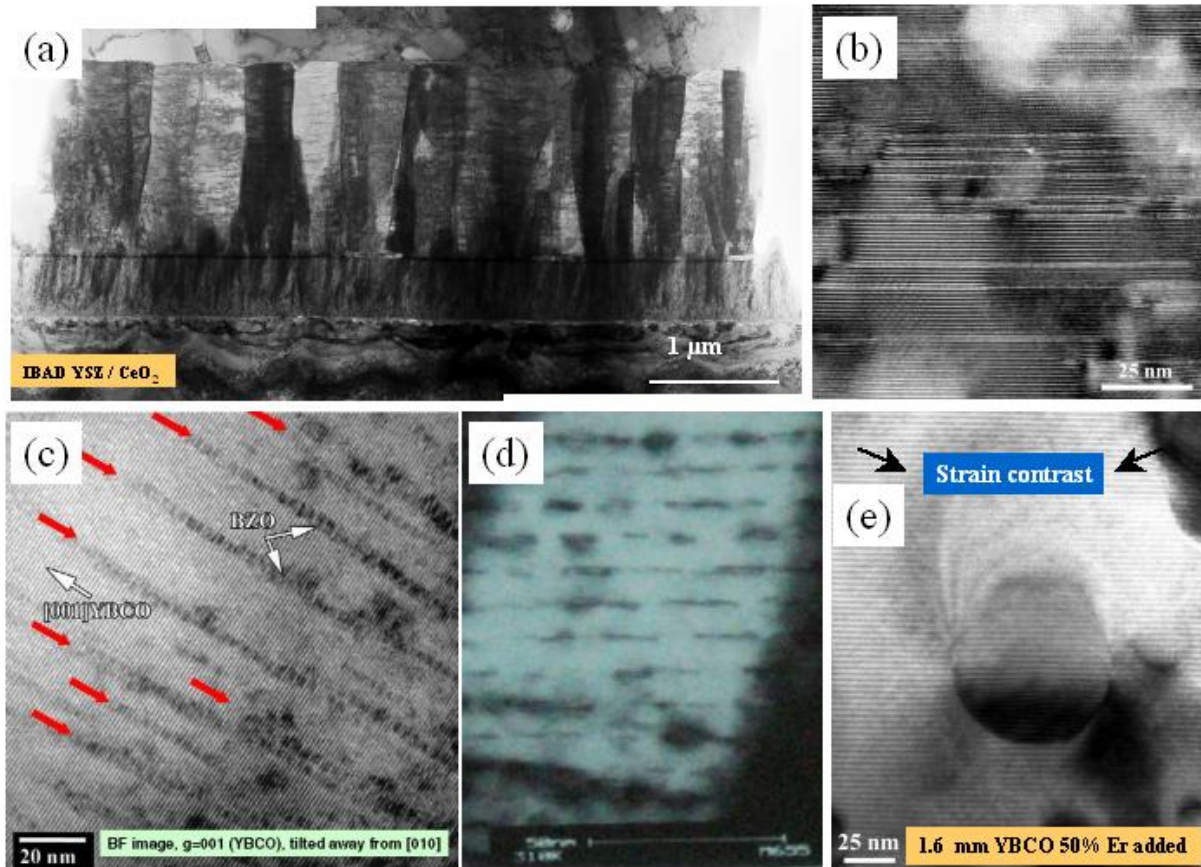

Figure 14 Some pinning structures in YBCO thin films and CC as seen by TEM. (a) Columnar growth of PLD films produces a proliferation of c-axis dislocations, which give rise to correlated pinning and a c-axis peak in J_c . (b) Laminar growth of ex-situ films (such as MOD in this image) results in absence of c-axis dislocations and associated J_c peak. In contrast, a large density of extended defects along ab (Y-124 intergrowths) produce correlated pinning and concomitant larger J_c peak for \mathbf{H} //ab. (c) Columnar defects produced by stacking of BZO nanoparticles (self-assembly) in PLD YBCO produce large c-axis peak in J_c . (d) Incomplete multilayers produced by periodic intercalation of Y_2BaCuO_5 (the 211 phase) in PLD YBCO also results in large pinning enhancement for broad angular orientations of \mathbf{H} . The periodicity produces matching field effects for \mathbf{H} //ab. (e) Addition of rare-earths in MOD films produces precipitation of nanoparticles with associated strain fields, which also produce large pinning enhancement for broad angular orientations of \mathbf{H} .

FURTHER READING: VORTEX PHENOMENA

1. A.M. Campbell and J.E. Evetts, "Flux vortices and transport currents in type II superconductors," *Advances in Physics* **21**, 199 (1972).
2. Yu N. Ovchinnikov and B.I. Ivlev, "Pinning in layered inhomogeneous superconductors," *Phys. Rev. B* **43**, 8024 (1991).
3. D.R. Nelson and V.M. Vinokur, "Boson Localization and Correlated Pinning of Superconducting Vortex Arrays," *Phys. Rev. B* **48**, 13060 (1993).
4. G. Blatter, M.V. Feigel'man, V.B. Geshkenbein, A.I. Larkin, and V.M. Vinokur, "Vortices in High Temperature Superconductors," *Rev. Mod. Phys.* **66**, 1125 (1994).

5. Y. Yeshurun, A.P. Malozemoff, and A. Shaulov, "Magnetic relaxation in high-temperature superconductors," *Rev. Mod. Phys.* **68**, 911 (1996).
6. David Larbalestier et al. "Strongly linked current flow in polycrystalline forms of the superconductor MgB₂," *Nature (London)*, **410**, 186 (2001).
7. David Larbalestier, Alex Gurevich, D. Matthew Feldmann and Anatoly Polyanskii, "High-T_c superconducting materials for electric power applications," *Nature (London)*, **414**, 368 (2001).
8. S.R. Foltyn et al. "Strongly coupled critical current density values achieved in Y₁Ba₂Cu₃O_{7-δ} coated conductors with near-single-crystal texture," *Applied Physics Letters* **82**, 4519 (2003).
9. T. Haugan, et al. "Addition of nanoparticle dispersions to enhance flux pinning of the YBa₂Cu₃O_{7-x} superconductor," *Nature* **430**, 867 (2004).
10. J.L. MacManus-Driscoll et al. "Strongly enhanced current densities in superconducting coated conductors of YBa₂Cu₃O_{7-x} + BaZrO₃," *Nature Materials* **3**, 439 (2004).
11. V. Braccini et al. "High field superconductivity in alloyed MgB₂ thin films," *Phys. Rev. B* **71**, 012504 (2005).
12. S.R. Foltyn et al. "Overcoming the barrier to 1000A/cm width superconducting coatings," *Applied Physics Letters* **87**, 162505 (2005).
13. Special issue, "High Performance YBCO-coated Superconducting Wires," edited by M. Parans Paranthaman and Teruo Izumi, *MRS Bull.* **29**(8), August 2004.
14. See presentations in DOE *Superconductivity for Electric Systems Annual Peer Reviews and Wire Development Workshops* at:
<http://www.energetics.com/supercon04.html>. - <http://www.energetics.com/wire05.html>.
<http://www.energetics.com/supercon05.html>. - <http://www.energetics.com/wire06.html>.

Theory

INTRODUCTION

The history of superconductivity over the past two decades has been one of discovery driven research and paradigm shifts. The most significant of these was the discovery of cuprate-based high temperature superconductivity (HTS). Prior to this discovery, the theory of superconductivity was well established, the maximum T_c had reached a plateau in the low 20's K, and the compounds where high critical temperatures were thought likely – cubic, high density of states metallic compounds – had been extensively studied. The discovery of HTS led to critical temperatures exceeding 150K as well as major advances in theoretical understanding of unconventional (non s-wave) superconductivity. Perhaps of equal significance, the paradigm shift brought about by cuprate superconductivity led to a new openness to exploring the possibility of superconductivity in materials that do not fit into current families of superconductors, as well as new mechanisms and new types of superconductivity. The result has been the discovery of many new superconductors, not yet exceeding the highest cuprate T_c , but very well above the pre-cuprate plateau as well as the finding of new types of superconductivity different from both the conventional s-wave electron phonon materials and the cuprates. These novel materials include (Ba,K)BiO₃ (while its low- T_c prototype, Ba(Bi, Pb)O₃ had been known, this modification with $T_c \sim 35$ K was proposed from calculations before it was synthesized), various carbon-based superconductors such as A₃C₆₀, MgB₂, and Li_xHfNCl, all superconducting above 25K, and other surprises include doped diamond, Sr₂RuO₄, PrOs₄Sb₁₂, PuCoGa₅ (an 18 K heavy-fermion superconductor, an order of magnitude higher than in any known f-electron system), various elements (including Fe) under high pressure, hydrated Na_xCoO₂ (the five examples most likely exhibit unconventional pairings). Moreover, a great variety of carbon-based superconductors are being discovered: organics, nanotubes and novel intercalated graphites; several other examples could be given.

During the past two decades, the theoretical research of superconductivity has spanned a broad range from a theoretical basis of understanding and optimizing the material properties relevant for energy applications, such as critical magnetic field and critical current density, to fundamental challenges of the theory of superconductivity, including unconventional superconductivity, pairing symmetry, strong electronic correlations, and coexistence of superconductivity with other types of ordering (e.g., magnetic).

It is worth noting that since the discovery of the high- T_c superconductivity a qualitatively new understanding of the field has emerged, that superconductivity is a much more ubiquitous phenomenon than it had been thought before. Conventional electron-phonon BCS superconductivity, the only kind known for the first 85 years since the discovery of superconductivity, is but a tip of the iceberg and now we are just starting to scratch the surface of this iceberg beyond that tip. The two examples of usable materials that have been excavated from the submerged until recently part of the iceberg are the high- T_c superconducting cuprates that have advanced more than half way from the absolute zero to the room temperature, and MgB₂ with a number of advantages stemming from the two-band nature of superconductivity in this compound. As was demonstrated by detailed calculations following the discovery of MgB₂, the theory in this area has come of age. Because of advances in first principles methods assisted by advances in computer speed, quantitative calculations of superconducting parameters, including full Eliashberg functions and T_c , are now possible for several important superconductors. Although MgB₂ was discovered by experimental investigation in Japan, it could have been predicted theoretically using tools in place if theoretical/computational searching had been a priority, and if superconductivity had been anticipated in this type of material. Advances in first principles calculations and in computers are making it possible to do detailed electron phonon calculations for quite complex materials in the near future. Work along these lines is already paying dividends, for example, through predictions of various modifications to doped diamond, MgB₂ and fullerene systems to increase T_c . One of the more notable predictions is a much higher T_c , in the range of the cuprates, when doping fullerenes smaller than C₆₀.

MECHANISMS AND OTHER FUNDAMENTAL ISSUES

As mentioned, advancing the fundamental theory of superconductivity is a necessary component and an investment in the future successes in the area of superconducting technologies. Indeed, ever since the discovery of superconductivity every major advance in this field required cardinal changes in thinking about the phenomenon.

Most important materials discoveries in superconductivity

Material	year	Country	Pairing symmetry	Pairing mechanism	note
Hg	1911	Holland	S	phonons	First superconductor
	1972	US	P	Spin fluctuations	First triplet fermion pairing
Nb ₃ Ge	1973	US	S	Phonons	Highest pre-cuprate T _c
	1979	Germany	?	?	First unconventional superconductors
Bechgaard salt	1980	France	?	?	First organic superconductor
(La,Ba)CuO ₄	1986	Switzerland	D	?	First High-T _c material
YBa ₂ Cu ₃ O ₇	1987	US	D	?	First “liquid-nitrogen” superconductor
(Ba,K)BiO ₃	1988	US	S	Phonons?	First theoretically predicted superconductor with T _c >20K
A ₃ C ₆₀	1991	US, Japan	S	Phonons	Strongly non-adiabatic system
HgBa ₂ Ca ₂ Cu ₃ O ₈	1993	Russia	D	?	The highest known T _c
Sr ₂ RuO ₄	1994	Japan	P?	?	First solid state triplet superconductor?
UGe ₂	2000	UK	?	?	Bulk coexistence of superconductivity and ferromagnetism
MgB ₂	2001	Japan	S	Phonons	Two gap superconductivity
Li under pressure	2002	Japan	S	Phonons	The highest T _c elemental metal
Na _x CoO ₂ ·yH ₂ O	2003	Japan	?	?	Likely f-wave or odd-frequency superconductivity
doped diamond	2004	Russia	S	Phonons	First observation of superconductivity in 3D carbon
CaC ₆	2005	UK	S	Phonons	Highest T _c in intercalated graphites

The first such change was the 1957 BCS theory with the concept of electron pairing, against the conventional arguments like Pauli exclusion and Coulomb repulsion. Now we know that the BCS superconductivity is just the simplest realization of this concept and only relatively recently we have realized how immense the opportunities beyond the BCS theory are. It is also clear that even among already discovered materials the BCS superconductivity and the d-wave superconductivity in cuprates are only the two best studied classes among many. On the other hand one very powerful idea is that both high temperature superconductivity in cuprates and superconductivity near quantum-critical points in a number of heavy-fermion materials have the same or similar underlying physics.

It is very important to emphasize that today the theory of superconductivity has two major issues: conventional and unconventional superconductivity. The former (the most important practical application being arguably MgB₂), is understood at the level of the basic physics. Notwithstanding a number of unresolved questions, as discussed above, the challenges in terms of predicting and designing new material are largely technical and are discussed in more detail in the next section.

The latter deals with the materials (two examples are cuprates and heavy fermion compounds) where there is no consensus about the mechanism even on the most fundamental level, except from the fact that they are qualitatively

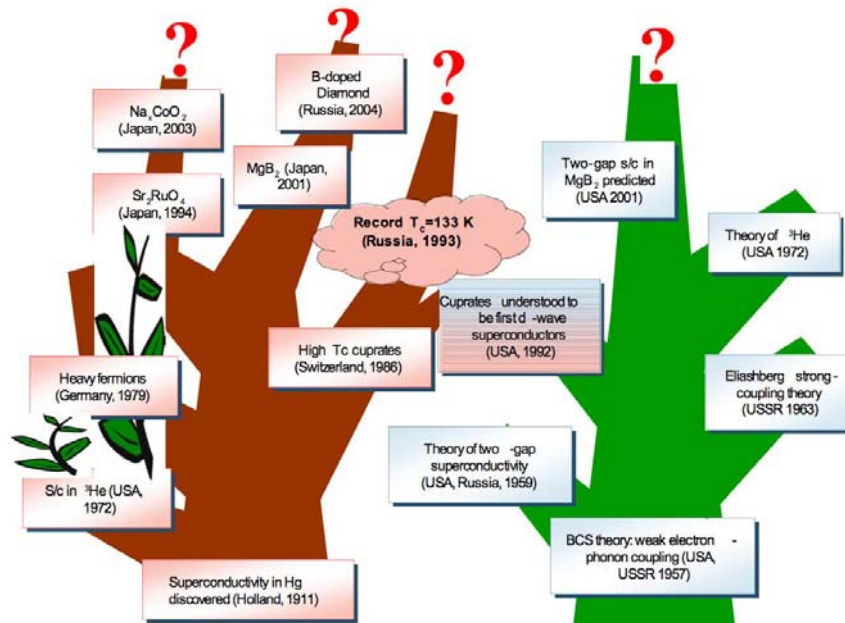

Figure 15 For the first 85 years since the discovery of superconductivity (or, shall we say, for the first 30 years after creating the theory of this phenomenon) the search for new and improved materials had concentrated on the conventional strong-coupling superconductors, the concept of unconventional superconductors beyond the one s-gap and electron-phonon coupling, albeit existent, bearing a stigma of impractical esotericism, limited by theoretical exercises and ^3He . After the discovery of the high- T_c cuprates and realization that the relevant pairing symmetry is d-wave, a new era started where the exploration ground became immensely expanded. This chart illustrates the “superconductivity tree,” showing the direction of exploring new facet of unconventionality and new materials deviating from the BCS superconductivity in more and more substantial ways: more and more unconventional superconducting states are proven or conjectured along the line of BCS superconductor \rightarrow MgB_2 (two gap superconductivity) \rightarrow High T_c cuprates (d-wave) \rightarrow Sr_2RuO_4 (chiral superconductivity) \rightarrow $\text{Na}_x\text{CoO}_2 \cdot y\text{H}_2\text{O}$ (f-wave or odd-frequency?) \rightarrow heavy fermions (all of the above?)

different from the “old” superconductors and the challenge is to gain the basic microscopic understanding of such unconventional superconductivity, before one can indulge in a theoretical and computational search for new, potentially qualitatively superior, superconductors.

PRINCIPAL DIRECTIONS OF THE THEORY

Putting the above in more details, the following principal directions of theoretical inquiry can be emphasized.

Conventional BCS-like superconductivity

Here we speak about the concept of superconductivity as a coherent condensation of Cooper pairs, arising from exchange of virtual phonons or other elementary bosonic excitations.

BCS-phonon mediated superconductivity has had a unique success in quantitative description of conventional superconductivity (some say, it is the most successful quantitative theory in solid physics). Moreover, it was

successfully generalized to describe multi-band superconductors equally well (and recently applied to MgB_2). We know now that the old creed that the phonon mechanism has inherent limits for the critical temperature (~ 30 K) due to the lattice stability was unfounded; the key is separating different lattice (phonon) subsystems, with one subsystem responsible for superconductivity and another for holding the lattice together; prospects of room temperature superconductivity based on the conventional phonon mechanism are being seriously discussed. Importantly, revisiting the old theory uncovered a number of open issues, subject to future investigation: new role of the lattice stability (soft modes vs. strongly interacting hard modes); pair-breaking in multi-band superconductors; ultra-strong coupling (polarons, bipolarons, local pairs); strong electron-phonon coupling signatures in spectroscopic probes.

BCS non-phonon mechanism implies that the material has unconventional superconductivity with electron pairing induced by exchange of non-phonon excitations. Such superconductors would not deviate from a regular Fermi liquid metal in the normal state in any drastic way, and its properties would be reasonably well described by the conventional theory (with a possible reservation of a Migdal theorem failure due to large energies of intermediate bosons). A number of charge and spin excitations have been proposed, most popular being ferro- or antiferromagnetic spin fluctuations. Superfluidity in ^3He is an early and well studied example in which spin-fluctuations are believed to mediate unconventional BCS pairing. A number of researchers believe that the essential physics in HTS cuprate can be understood along this route as well. An offshoot of such theories is the problem of “interference” of different types of bosons, such as phonons and spin fluctuations: new phases that cannot be stabilized by any of the two bosons alone sometimes emerge, in which the bosons sometimes act constructively, sometimes destructively, enhancing again the richness of the relevant physical picture.

Beyond BCS

A number of metals exhibit a non Fermi liquid normal state, in contrast with the BCS assumption that the superconducting state emerges from a Fermi liquid. Some preliminary attempts have been made to address the issue of how to pair “non Fermi liquid” electrons in unconventional superconductors, particularly in models exploring spin fluctuation mediated pairing.

Heavy Fermions. Probably the first example of this sort are heavy fermions. These materials represent a novel correlated state of matter where localized spins participate in the formation of an itinerant Fermi surface. Some of them were found to superconduct starting back in 1979, an unusual finding since magnetism was thought at that time to be detrimental to the formation of a superconducting ground state. Despite 27 years of their known existence, and with many examples now (perhaps the most impressive being the 18K superconductivity of PuCoGa_5), the pairing mechanism and pairing symmetry are unknown. The superconductivity is almost certainly unconventional in nature. For instance, UPt_3 exhibits three superconducting phases, each of which has its own particular nodal structure, making this metal perhaps the most complex superconductor known. And, in many cases, the superconductivity probably has something to do with magnetic correlations. Support for this is the observation of superconductivity near magnetic quantum critical points, and the interrelation of spin dynamics and superconductivity in such systems as UPt_3 and UPd_2Al_3 . But, we are a long way from solving the challenging problem of superconductivity in heavy fermions, and the related problem of quantum critical physics.

Spin Charge Decoupling. Even more radical departures from BCS can occur in those systems where spin and charge excitations are decoupled in the normal state. A good example is the RVB idea of Anderson and co-workers, where d-wave pairing in the spin sector in the presence of doped carriers can lead to re-coupling of charge and spin degrees of freedom, and thus to superconductivity.

Three Particle Correlations. Perhaps an even more radical departure is to consider pairing emerging from underlying three particle correlations, which in some cases can lead to so-called odd frequency pairing, where the pairing wave function has nodes in time (as contrasted with the nodes in space of non s-wave superconductors). Finding such an “odd frequency” superconductor would provide an entirely new class of unconventional superconductivity.

Beyond Low Energy Excitations. Finally, one can take a broader view of superconductivity by abandoning the concept of intermediate bosons that becomes questionable when the claimed gluing bosons are collective excitations of the same conducting electrons. Instead, one can speak of an instability of the whole electron system, characterized

by an off-diagonal long range order in the density matrix, and ask the question where the corresponding energy gain comes from. This is particularly instructive in a case when superconductivity affects all or a substantial part of the electronic states, and not just the low-energy excitations. There is some recent evidence in cuprates for this, where changes in the optical conductivity occur for energies over 100 times the energy scale of the superconducting gap.

Superconductivity as a result of competing phases

Another observation (in fact, likely intimately related with the non-Fermi liquid behavior in the normal state) is that HTS as well as many other cases of unconventional superconductors appear in close vicinity of another, usually magnetic phase transition. The interplay between superconductivity and other symmetry breaking coherent states is often thought to be of crucial importance for unconventional superconductivity.

Quantum criticality. This problem is known under the name of quantum criticality. From the theory point, it appears that both ferro- and antiferromagnetic quantum critical points bring rather different physics, and itinerant ferromagnets in many aspects are more difficult to handle than the localized systems (where, for instance, the powerful machinery of the dynamic mean field theory can be exploited).

Mott-Hubbard insulating phase. It is now well known that in the most famous case, in high T_c cuprates, the Mott-Hubbard insulating phase and the d-wave HTS phase occur next to each other. While it still unclear whether strong Coulomb correlations, associated with Mott-Hubbard transitions play a direct role in superconductivity or affect it indirectly, there is no doubt that profound understanding of the physics of the Hubbard model is indispensable for cracking the HTS mystery.

Intrinsically inhomogeneous systems. Some of the superconducting systems are intrinsically inhomogeneous. This inhomogeneity could be intrinsic, due to frustrated interactions (stripes and checkerboard states are but few examples) or extrinsic due to disorder, dopants, etc. Understanding the nature of the pairing state and what advantages one can gain by creating inhomogeneous states is another theory challenge.

COMPUTATIONAL SUPERCONDUCTIVITY AND SEARCH FOR NEW MATERIALS

The impact of computational techniques in understanding superconducting phenomena, and modeling superconducting behavior, has expanded greatly in the past decade. For real materials studies (as opposed to models), the basic electronic and magnetic structure is essential input. For model studies, the complexity of the many-body problem requires a great deal of computational expertise and access to machines. This concentration on computational approaches arises from the growing realization that both the search for new and improved material and the microscopic understanding of the existing superconductors, is to large extent a quantitative problem. It requires detailed knowledge of the underlying electronic, magnetic and lattice dynamical properties of the material in question, as well as the mutual interaction among the three. Further advancement of the theory of superconductivity beyond weak coupling perturbational formalism (which is hardly applicable in the most interesting cases) requires stepping beyond oversimplified models.

The (non-perturbative) infinitely strong on-site Coulomb interaction approach, incorporating realistic parameters, is a very difficult problem notwithstanding its clear limitations. Absence of a small parameter thus calls for numerical approaches to solving such problems, most of which, like direct diagonalization or quantum Monte Carlo scale badly with system size. A rapidly growing effort is in the area of hybrid theories, striving to incorporate strong correlations into first principles band structure calculations, retaining the material sensitivity of the latter.

Once the theory has developed its basic theoretical framework so that the theory is understood, the key challenge is in material-specific implementations to understand superconducting phenomena and predict likely improvements, a necessity will be well developed software and modern computational facilities. Such developments are necessary both for conventional and non-conventional superconductors, since only such well developed theoretical methods can be applied to identify new families of superconducting materials and thus lead to discovery of new materials. As discussed above, parts of this framework are in place, but important challenges remain.

Migdal-Eliashberg Theory: within, and beyond.

This conventional theory of electron-phonon coupling was thought to be well understood by the end of the 1970s, when effort began to be redirected to the (important, certainly) issues of anharmonicity and of effects of lattice instabilities. If the theory was well in hand, then it was the materials that were not understood. In 2001 Akimitsu introduced the world to a very simple material, MgB_2 , whose T_c is almost twice as high as the intermetallic transition metal compounds that had absorbed the energies of hundreds, perhaps thousands, or researchers, and substantial research funds of many agencies, for the best part of two decades. MgB_2 is simple structurally, it is simple electronically, and within four months several theoretical papers appeared elucidating in detail how the mechanism works! This example illustrates vividly that, even though a mechanism is well understood, its impact may be far from exhausted.

Phonon spectra and electron-phonon interaction. Within the classical Migdal-Eliashberg theory the principal successes of the last decades largely derive from the development of new computer codes and the progress in the computational methods for calculating the phonon spectra and the electron-phonon coupling spectral functions from band structure calculations, utilizing the linear response formalism. In addition, techniques have been perfected or newly developed to calculate a variety of derived superconducting properties, such as anisotropic gap distributions, thermodynamic functions, behavior in magnetic field etc. Computational challenges have limited most applications to simpler systems. Even in simple (structurally as well as electronically) materials, unexpected numerical complexity can emerge. A vivid example is provided by elemental lithium under pressure, which becomes superconducting up to 20 K under 60 GPa pressure. Its electronic structure, and Cu-like Fermi surface, could hardly be simpler, yet the integrand in the momentum-space integral that determines the electron-phonon spectral function and total coupling strength λ is found to have extremely fine structure that requires exacting computations. More complex Fermi surfaces necessitate correspondingly more extensive computations.

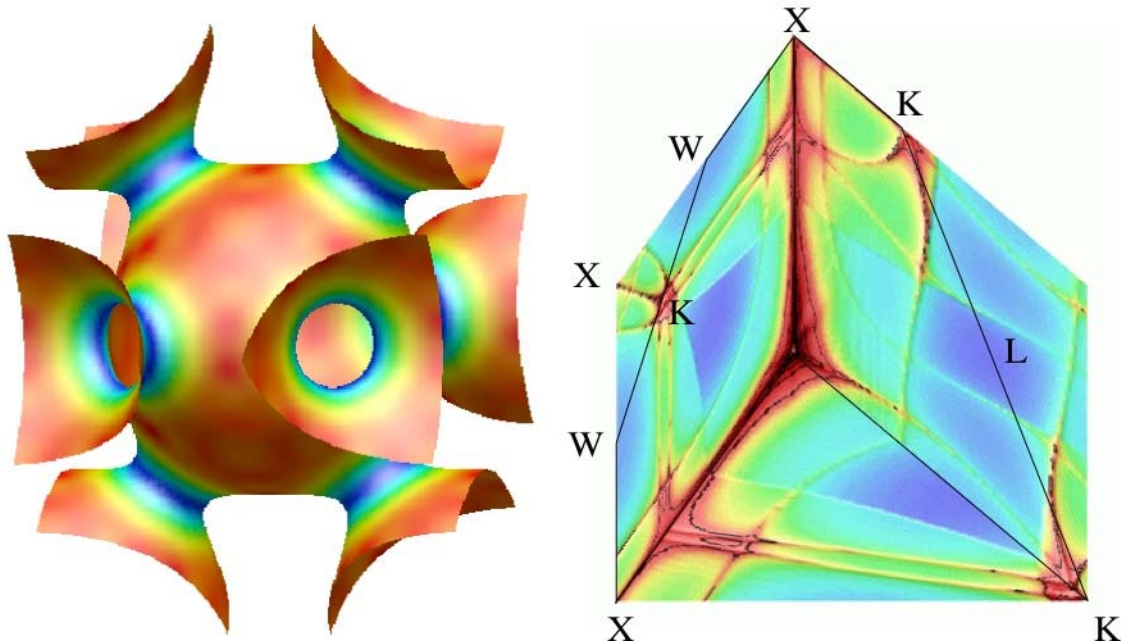

Figure 16 Left panel: Fermi surface of Li at 35 GPa colored by the value of the Fermi velocity. Right panel: Planar plots of the nesting function defining the electron-phonon coupling spectral function. To obtain the fine structure, a cubic k mesh of 2×10^6 points in the Brillouin zone was used.

Generalizations and expansions. It has become increasingly clear however that in the most interesting conventional superconductors the classical theory needs to be generalized and expanded. In some materials (A_3C_{60} is the best example) the phonon energy scale is no longer small compared to electron band width. This situation calls for non-adiabatic approaches, abandoning the Migdal theorem and including vertex corrections to the electron and phonon propagators. Some systems are thought to involve nonlinear (multiphonon) interactions (MgB_2) and ultra-strong, double-well anharmonicity ($MgCNi_3$). In other systems treatment of Coulomb and magnetic effects beyond the retarded Coulomb pseudopotential is essential. In MgB_2 the variation of coupling strength among phonons varies by a factor of 100, and the phonons with strongest coupling require fundamental extensions of the theory.

Ultra-strong electron-phonon coupling. Many experimental observations remain poorly understood. For instance, despite the impressive success of the quantitative theory of superconductivity in describing MgB_2 , the 50% suppression of the isotope effect in this system remains unexplained. Quantitative first principle calculations for ultra-strong electron-phonon coupling, eventually reaching the polaronic limit, are still a matter of the future.

Lattice Dynamical Effects. A number of experiments in recent years has renewed interest in the character and consequences of electron-phonon interaction in cuprate HTS, and has revived study of the possibilities of involvement of EP coupling in the mechanism. The “kink” in the quasiparticle band seen in ARPES is thought by several workers to be related to phonons, and inelastic neutron studies of the phonon spectrum directly identifies consequences of strong EP coupling especially at low doping, some of which extends to optimal doping. More generally, there is the realization that to address the important low energy data in a serious manner, phonon effects must be included; after all, phonons extend all the way to zero energy. Ground-breaking efforts to model in a relevant fashion both strong electronic correlation and strong EP coupling, and their interplay, has appeared recently but is confined to the very low doping regime so far. Moving to larger doping will require heavy computation, along with perhaps extensions of theory and algorithms.

Generalizations of Density Functional Theory to the Superconducting State

Another of the limitations of the conventional Eliashberg methodology is its inability to handle Coulomb repulsion beyond the retarded Coulomb pseudopotential approach. A fundamentally new approach, developed by E.K.U. Gross and collaborators, capitalizes on the tremendous success of density functional theory by generalizing the total energy expression to become a functional of the superconducting order parameter as well as density. This self-consistent approach has no adjustable parameters, and includes the Coulomb repulsion on a first principles basis. The current implementation requires model functionals, most specifically Fermi-Thomas screening of interelectronic Coulomb repulsion, but the approximations are leading to excellent values of the critical temperature T_c . This method has only been applied to real materials in the past two years ago, but holds extraordinary promise. The recent generalization to spin fluctuations is just one of the important avenues available to this approach.

Strongly Correlated Superconductors

Many of the novel superconductors, including the HTS cuprates and the heavy fermion metals, are strongly correlated materials. There has been extensive progress in our understanding of strong Coulomb correlations, largely brought in by computational studies. Several aspects of unconventional superconductivity, both of the type seen in cuprates and even more exotic flavors, are now becoming understood. Currently it is possible to treat many-body models thought relevant to cuprates with realistic size simulations cells, using numerical techniques. These efforts provide the concepts and leading models for understanding the spectroscopic features seen in cuprates, and there continues to be the expectation that this field of study is one of the important roads to a theory of cuprate superconductivity with experimentally verifiable predictions.

Hubbard Model. One school of thought is that the simplest framework that includes the essential physics of strong correlations is the Hubbard model, although to understand many aspects of these materials going beyond the simplest one-site, one-band model will be essential. Unfortunately, analytical methods make progress on the problem only in one dimension, or in the special limiting cases like infinite Coulomb repulsion. Because of these restrictions, most of our knowledge of the behavior of Hubbard models and their possible superconducting phases are derived from numerical approaches including direct diagonalization, quantum Monte Carlo, numerical renormalization group, dynamical mean field theory, as well as some other numerical methods. For example, the basic two-dimensional square lattice Hubbard model, comprised of kinetic energy and onsite Coulomb repulsive

interaction, has been the focus of a variety of numerical studies. Early Monte Carlo calculations showed that the ground state of the half-filled system (*i.e.* no carrier doping) has long range antiferromagnetic order. Recent dynamic cluster Monte Carlo calculations find evidence for $d(x^2-y^2)$ superconductivity for the doped system as most observations conclude to be the case for HTS cuprates, Numerical density-matrix-renormalization-group calculations on a doped 6-leg Hubbard ladder find an inhomogeneous (“stripe”) ground state in the intermediate to strong interaction regime. Whether these results are truly definitive, or require more extended computations, is currently under discussion. Nevertheless, the phenomena seen in the Hubbard model and their delicate balance remind one of the actual cuprate materials. It is important to understand more fully the structure of the interaction which leads to $d(x^2-y^2)$ pairing correlations in this model. Numerical methods for doing this are being implemented and applied. The need for continued and extended investigation of such strong interaction models crucially depends on the availability of large-scale computation and the education and training of young scientists in the area of computational many-body physics.

Material Specificity. A theory with some degree of material-specificity is a prerequisite for it to be useful in guiding a search for better superconductors in this class. This material-specific aspect is not yet at hand. The substantial computational difficulty in dealing with the correlated state has dictated that models contain only the bare-bones aspects of the problem, and none of the real complexity of HTS that does however affect data including T_c and complicate its interpretation. In this area of strongly correlated models which is most clearly present in the underdoped region of the phase diagram, algorithmic development and computational efficiency still must be a priority. Notable progress is being made in this area.

Wannier Functions. On one hand, techniques have been implemented to cast the results of full first principle calculations onto simplified but more realistic models than discussed above. The principal progress here is due to development of new methods of projecting the band structure onto a set of well-localized Wannier functions, justifying the neglect of peripheral degrees of freedom exactly (an example of this approach is the order-N LMTO method developed in Stuttgart). Substantial progress has been made very recently in the challenging task of calculating the Hubbard U from first principles, and more is expected in the nearest future.

Dynamical Mean Field Theory. On the other hand, a distinct and more radical direction of treating strong correlations on a material-specific basis is due to a substantial progress in *ab initio* implementations of the (DMFT). This local but dynamic approach has already substantially extended our understanding of the material aspects of strong correlations. However, superconductivity, not being a local phenomenon, has been relatively little addressed. This could change, if advances of cluster extensions of DMFT could be found to be applicable to the superconducting state.

Troublesome Existing Superconductors

Even leaving aside the HTS class, for which there are still strong differences of viewpoint, there are several examples of superconductors that pose conceptual difficulties. These problem superconductors clearly seem not to be strongly correlated, yet they don't fit our current understanding. One is BKBO ($Ba_{1-x}K_xBiO_3$), with $T_c \sim 35$ K. It was discovered almost simultaneously with HTS and thus has not attracted the attention that its impressive superconductivity deserves; it is after all by far the highest T_c oxide outside the HTS materials. Linear response calculations of the phonons and electron-phonon coupling strength have been reported, with the result that the strength is far from what is required to account for its observed value of T_c . A second system is the Li-intercalated nitridochlorides XNCl ($X=Zr$ with T_c up to 16 K; $X=Hf$ with T_c up to 26 K). Again, a report of the electron-phonon coupling strength from linear response calculation gives nowhere near the strength required to account for T_c . The first is three-dimensional with possible polaronic behavior, the second is strongly two-dimensional with the possible peculiarities associated with two dimensionality. Another impressive superconductor, YPd_2B_2C with $T_c=23$ K, is not understood although it lies atop a broad class of borocarbides that clearly show strong electron-phonon coupling. As mentioned earlier, even in such a banner example of a theoretical success as MgB_2 there are unresolved issues. The basic theory necessary to address each of these systems is probably available, but substantial computational efforts will be required to address the issues seriously.

No doubt there are more ‘troublesome’ examples, of the same sort or different in nature. One example is $PuCoGa_5$, a heavy fermion superconductor. Granted that HF superconductivity is now discussed in only the most general terms

as arising from magnetic fluctuations, this is the singular example in this class with T_c an order of magnitude higher than any other heavy fermion material.

Computational Search for New Superconductors

When bringing up the possibility of using the computer to search for new superconductors, the initial question has to be: is there a point? Is there some expectation of making an impact by performing exploration by computer rather than by furnace? Our linear response theory of electron-phonon coupling almost certainly applies to (most aspects of the) A15 compounds, although the calculations scale badly (i.e. they rapidly absorb a great deal more computer time as the metal becomes more complex).

Certainly the theory works well in MgB_2 , in boron-doped diamond, apparently in pressurized Li, where T_c reaches 20 K. This computational theory therefore seems to have considerable reliability for the conventional electron-phonon coupling systems. The question then is: is enough known, or suspected with some justification, to guide a search, given that one will be faced with performing calculations on the tiniest fraction of all possible materials? One can ask this same 'zero chance of success' question of the experimentalists, however, and it does not deter them (although it notoriously deters agencies from funding such serendipitous explorations very vigorously).

There is, thanks primarily to MgB_2 , now a set of extended guidelines to guide a search at least in quasi-two-dimensional materials. Light masses and strong bonds leading to high frequencies have long been known to be favorable for raising T_c . The problem is that these (often strongly) covalent materials are not metals and resist efforts to dope them to metallic conductivity. MgB_2 just happened to be, in a real sense, self-doped in a favorable way. Diamond is an excellent example: after long effort it has finally been found how to dope diamond heavily enough (p-type) to make it metallic, which was the objective. Totally as a surprise, it is found to be a very respectable superconductor (up to 12 K so far). MgB_2 has another feature, evident in the early calculations but only recently emphasized. Its two-dimensional electronic structure and simple Fermi surfaces provide *control* over the momentum-dependence of the strong coupling, opening the way to designing a MgB_2 -type material that makes even better use of its electrons and its phonons.

Superconductivity in (mostly carbon) nanostructures

Nanostructure affects superconductivity at two distinct levels: first, the effect of nanostructuring on the underlying materials parameters affecting superconductivity and, second, the interplay of nanostructure with the superconducting order parameter itself. Low dimensional systems based on robust and deformable sp^2 -bonded sheets, since they are embedded in three spatial dimensions, afford rich opportunities for tuning superconducting properties via nanostructure. For example, the curvature of sp^2 carbon sheets opens up new channels of electron-phonon coupling in alkali-doped C_{60} . The prime importance of surface energies, novel point-group symmetries of nanocomponents, the role of curvature, and the ability to integrate otherwise disparate chemical subunits all provide compelling opportunities to understand and improve existing superconductors, and to guide investigations into the discovery of entirely new classes of superconducting compounds. For instance, superconductivity in carbon nanotubes was reported in recent years, apparently in single nanotubes. There are also more reports of superconductivity in bundles or in more complex collections of carbon nanotubes. Very recently, a critical temperature of 12 K was reported in double-walled nanotubes, 20 times higher than in single-walled superconducting nanotubes.

THEORY OF SUPERCONDUCTING INTERFACE PHENOMENA

Research opportunities in superconducting interface phenomena, superconducting based electronics and spintronics as well as opportunities for fundamental studies on novel superconducting materials are provided by the combination of theoretical developments and experimental discoveries in unconventional superconductivity, controlled fabrication of mesoscopic and nano-scale magnetic and superconducting interfaces and theoretical developments in non-equilibrium superconductors and superconductor-magnetic interfaces. In the following we discuss developments and opportunities involving the principal superconducting interface phenomena.

Josephson Effect. The Josephson effect, *i.e.* charge transport by quantum tunneling of Cooper pairs, is perhaps the most remarkable and well known example of macroscopic phase coherence that is characteristic of the broken gauge symmetry of the superconducting state. That discovery not only provided a vivid demonstration of the role of phase coherence, but also the ability to control charge currents by manipulating the phase of the superconducting pair wave function. Indeed precision measurements of fundamental constants, *e.g.*, e/h , or local magnetic fields are based on the Josephson effect. Central to the Josephson effect, indeed all transport and optical properties of superconductors, is the interface between the superconducting material and another material. Josephson-type effects (*i.e.* phase-sensitive charge transport) can be observed in many different types of junctions, from tunnel junctions to heterostructures formed from superconducting leads coupled via a metallic interface to nano-meter scale metallic point contacts that restrict charge flow through a restricted channel. The structure and materials characteristics of the interface lead to qualitative and quantitative differences in the mechanisms for transport and, as a consequence, a rich diversity in the current-phase relations, the current-voltage characteristics, as well as the current and voltage fluctuations [noise spectrum] of such devices.

Andreev Reflection. Andreev reflection at an NS interface, *i.e.* branch conversion of electrons into retro-reflected holes, is a direct consequence of particle-hole coherence. In conventional superconductors this basic process is responsible for, or reflective of, the conversion of normal charge currents into supercurrents at NS interfaces, the superconducting proximity effect in normal leads, the non-linear (d.c. and a.c.) current-voltage characteristics of SIS, ScS and SNS Josephson junctions, as well as the suppression of heat transport in NS structures.

Josephson Effect in Unconventional Superconductors. Josephson effect becomes particularly interesting and informative in unconventional (d-wave or spin-triplet) superconductors. While there were numerous indications of unconventional pairing from bulk transport measurements in the high temperature superconductors, the identification of the d-wave pairing symmetry in tetragonal YBCO was based on the sensitivity of the Josephson current-phase relation to the broken reflection symmetry of the Cooper pair wave function (related studies are in progress for a presumed spin-triplet superconductor, Sr_2RuO_4). This is a general property of unconventional pairing – the Josephson current-phase relation depends on the relative orientation of the Cooper pair wave function to the interface normal. This provides an interface spectroscopy for the pairing state, the possibility of transitions observable in the Josephson critical current as a function of interface orientation, transmission probability and temperature.

Andreev Scattering in Unconventional Superconductors. Unconventional superconductivity also leads to new phenomena in connection with Andreev reflection. Interface scattering of excitations leads to multiple Andreev scattering and the formation of interface bound states with sub-gap energies that are often near the Fermi level, particularly if the excitations scatter from regions of the Fermi surface in which the superconducting pair wave function undergoes a large change in phase in momentum space, *e.g.* the reflection from a [110] interface in YBCO leads to a change in phase of the coherence amplitudes for reflected excitations relative to incident excitations and the formation of a surface Andreev states at the Fermi level. These states are unique in that they are bound to the surface with the range of order of the superconducting coherence length, yet they transport charge currents over comparable distances before the current is converted to a bulk supercurrent. The observation of these states as large zero-bias conductance peaks for tunnel junctions also provided direct evidence of d-wave pairing in several high T_c superconductors. Indeed the zero-bias and low-energy sub-gap surface states of unconventional superconductors provides a rich spectroscopy of both bulk and surface superconducting states that is sensitive to interface transmission, magnetism and disorder. Much of the dynamical effects associated with these novel states are unexplored.

Exotic Surface Phases. Exotic surface phases exhibiting broken time-reversal symmetry in the form of spontaneous interface currents, as well as nonlinear I-V characteristics and unique magnetic field dependences are predicted theoretically. Evidence for these novel surface states has been reported, but relatively little is known about the nature or origin of these surface and interfaces states, their dependence on interface chemistry or interface electronic structure. The possibility of new electronic device applications based on novel Josephson current-phase relations, interface bound states, surface superconducting phases and more generally phase-sensitive transport in unconventional superconductors is essentially unexplored.

Transport in Superconducting/Magnetic Structures. Opportunities for basic and applied research, with potential device applications, also exist in the area of transport across superconducting/magnetic interfaces. Spin-polarized

transport in ferromagnet/insulator/superconductor (FIS) junctions, pioneered by Tedrow and Meservey, demonstrated that spin-polarized currents in superconductors can persist long after tunneling through an insulating barrier. These studies also established a sensitive technique for measuring the spin polarization of magnetic thin films. Theoretical descriptions of these junctions with conventional superconductors provided insight in the interplay of ferromagnetism and superconductivity in the limit of low interfacial transparency, as well as a mechanism for Josephson tunneling between superconductors with different spin symmetry and parity.

Recent theoretical developments in the theory of inhomogeneous, non-equilibrium superconductivity with interfaces to magnetic materials provide new opportunities for first principles computational approaches to non-equilibrium spin and charge transport in superconducting/magnetic heterostructures, opportunities that were technically out of reach. These developments extend the traditional quasiclassical transport equations for non-equilibrium superconductivity to incorporate transmission by magnetic metals, semiconductors and insulators, magnetic proximity effects in superconducting leads (FS and FSF structures), coherent spin transport in superconducting-ferromagnetic-superconducting (SFS) Josephson junctions, as well as coherent, long-range spin-transfer torques in more complicated SFS heterostructures, e.g. FSFNFS junctions. FSFSFS multilayers with conventional superconductors exhibit many fascinating effects that have only recently been revealed, including long-range proximity-induced spin-triplet superconductivity, effects of magnetization orientation in ferromagnetic regions on the suppression of superconductivity and changes in the current-phase relation for SFS Josephson junctions.

New Phenomena in Superconducting/Magnetic Structures. The range of new phenomena associated with superconducting/magnetic interfaces is growing, and represents a rapidly expanding area of research that promises novel phenomena at the fundamental research level and significant opportunities for applied research in the area of superconducting charge- and spin transport. Some of these recent developments are highlighted below. All represent initial studies which point to substantial research directions.

Spin-polarized Currents. Spin-polarized currents may be generated by driving conduction electrons through a “spin filter,” an interface with different transmission probabilities for spin up and down electrons. Another generic effect of spin-active interface scattering is “spin mixing,” in which spin-up and spin-down electrons acquire difference phase shifts upon transmission or reflection by a spin-active element. The relative phase shift, the so-called “spin mixing angle,” leads to rotation of the direction of the spin polarization analogous to Faraday rotation of linearly polarized photons.

Spin Mixing in Transport Properties. Spin mixing plays a central role in spin, charge and heat transport through spin-active Josephson junctions, i.e. two superconducting leads coupled via a spin-active interface such as a FM metal or semiconductor. Spin-mixing is predicted to give rise to π -junction behavior, as well as complex features in the I-V characteristics of the charge current, i.e. the “sub-harmonic gap structure (SGS).”

Special SF Structures. SF structures based on conventional singlet superconductors and half-metallic ferromagnets have been realized. These half metals, theoretically predicted two decades ago, are most effective spin-filters and provide sources and analyzers (spin filters) for spin-polarized quasiparticle and pair currents. Predictions of a new type of Josephson effect in S/half-metal/S junctions are based on the spin mixing effect, leading to singlet-triplet mixing at S/F interfaces in combination with spin-flip interface scattering. The result is a spin-triplet supercurrent in the half metal with singlet-triplet conversion of the supercurrent in interface region. A recent experimental report of spin-triplet supercurrents in a half metal appeared this year in the journal Nature. Both theory and experiment are in the initial phases, and the potential for interesting phenomena and applications appears high.

Hybrid Structures. Hybrid structures comprised of superconducting and ferromagnetic elements offer a unique opportunity to generate and control coherent spin transport with otherwise conventional electronics. In order to manipulate spin currents in spintronic circuits, it is essential to include elements with highly nonlinear spin current-voltage characteristics. Recent theoretical results predict that voltage-biased SFS junctions can serve as tunable spin filters as well as spin-current oscillators. There is a rich structure to the dynamics of the spin transport in these and related devices that is only recently being addressed theoretically, yet appears to offer a wide range of phenomenology and potential for superconducting based spintronics.

THEORY FOR APPLICATIONS

Understanding the fundamental mechanisms of superconductivity, predicting and designing new superconducting materials with controllable properties, and discovering new and potentially useful phenomena, are all crucial to the design of innovative new energy technologies. The unprecedented success in the phenomenology of superconductivity has formed the basis of a new branch of condensed matter physics, the Physics of Vortex Matter. Vortex Matter Physics has attracted a broad interdisciplinary community of physicists, materials scientists and engineers working on diverse advances in the statistical physics of disordered media, contemporary quantum mechanics and nonlinear physics of complex systems to focus on disordered and nanostructured superconductors. Recent progress in synthesizing new materials and compounds, in which superconductivity coexists with other states of matter (such as antiferromagnetism or heavy-fermion electronic system) opens a new and largely unexplored field of basic research, where we can expect many new effects and phenomena to be discovered. Impressive developments in molecular beam epitaxy and film-growth techniques now enable the design of artificial nanoscale multilayer structures in which superconducting layers can coexist with magnetic, semiconducting or ferroelectric layers. We are at the verge of understanding the fundamental physics of static and current-driven vortex structures in these complex superconducting compounds and hybrid structures, which could have an enormous potential for applications. For example, the recent intensive work on MgB_2 has shed new light on the phenomenology of macroscopic magnetic properties of two-gap superconductors. Progress in this direction is essential in view of high-field applications of MgB_2 and for understanding magnetic properties of new and of some existing superconductors which may also have multiple gaps. The key lines of the past success in the physics of superconductivity that laid the foundation for a new emergent science include:

The concept and basic properties of vortex matter

Vortex solid: vortex glass and structural transitions. The original Abrikosov theory stated that magnetic field penetrates type II superconductors in the form of a regular array of vortex lines, *the vortex lattice*. The enhanced role of thermal fluctuations in high temperature superconductors helped to establish the important result that the vortex lattice melts at a certain melting line $B_m(T)$, similar to the usual atomic lattice, and the resulting vortex liquid phase occupies a significant part of the type II superconductor phase diagram. Another important result of the phenomenology of the type II superconductor is that disorder, which inevitably exists in all ‘real’ materials, pins the vortex lines in the vortex solid phase. In a random field of defects, these vortex lines can bend and deform to adjust themselves into the most favorable pinning positions and the vortex lattice transforms into what is called a *vortex glass*. The basic property of the vortex glass is that the vortices remain immobile under currents less than the critical depinning current. Thus it is the glassy phase of the type II superconductor that is responsible for one of its basic properties, the ability to carry loss free current. The primary task of theory with respect to technological applications is to increase the useful portion of the phase diagram by pushing the glass melting line towards higher fields and temperatures. An important step in this direction was the prediction and experimental realization of the *Bose glass*, a vortex solid phase formed by vortices pinning on columnar defects artificially introduced into a superconductor. The geometrical match between the linear vortices and cylindrical shape of the columnar defects significantly increased vortex pinning and resulted in the highest critical currents achieved so far (see section on vortex phenomena). Furthermore, columnar defects prevent vortex wiggling and thus suppress the effect of thermal fluctuations, shifting the vortex melting line in the phase diagram towards higher fields and temperatures.

Another important advance in vortex physics was the discovery of novel structural transitions within the vortex solid state which have a profound effect on the critical current. One such example is the disorder-induced transition of a vortex lattice into an amorphous vortex solid with increasing applied magnetic field which causes a sharp increase in the critical current in a narrow interval of magnetic fields near the transition. In addition, the realization that the structure of the vortex lattice is sensitive to the Fermi surface and the order parameter symmetry enabled the prediction and observation of a variety of vortex lattices whose structure evolves with changing field, temperature, and mean-free path.

Vortex liquid. In the *vortex liquid phase*, weak disorder cannot completely impede vortex motion. Thus, a vortex liquid by its electrodynamic properties is nothing but a good metal. Columnar defects, however, can lead to a partial arrest of the vortex motion giving rise to a novel intermediate state where Bose glass (i.e. true superconducting) islands can coexist with an unpinned viscous vortex liquid. This indicates an excellent opportunity to further extend the useful (in terms of low resistivity) part of the phase diagram even beyond the melting line and will constitute a new line of prospective search for a clever design of columnar defect configurations that can push the large critical current domain to higher temperatures. The novel intermediate phase where the normal metal (unpinned liquid) coexists with a true superconductor exhibits an interesting highly nonlinear electrodynamic response with many subtleties yet to be revealed.

Glassy electrodynamics of vortex structures.

Vortex creep. The pioneering discovery that changed our view on the behavior of disordered systems and clarified the origin of what we call a “glass” was the realization that the interplay between disorder, interactions of vortex lines, and superconducting fluctuations, gives rise to highly nonlinear electrodynamic at small currents: the response of the vortex solid to a small applied force is not proportional to the force, but follows an exponential dependence. In other words, the vortex glass does not follow Ohm’s law. This phenomenon which is now recognized as a fundamental generic behavior of all strongly correlated systems subject to quenched disorder, results from a specific structure of the energy configuration space and is closely related to aging and memory effects, i.e. constitutes the essence of what is referred to as *glassiness*. This creep dynamics restricts and modifies the basic ability of superconductors to carry loss-free currents. The vortex creep concept enabled a quantitative description of the rich variety of vortex electrodynamic which has accumulated over the past decade. Based on the creep concept, a quantitative theory of current flow in the highly nonlinear flux creep regime has been developed that can describe the dissipation and current-carrying capability of second-generation High- T_c coated conductors.

A combination of the effective medium concept and creep-based nonlinearity provided the basis for a quantitative description of transport properties in highly inhomogeneous superconductors, which can be viewed as a self-healing superconductor. Due to the high nonlinearity, the current concentrates within the strongest pinning regions redistributing itself in order to guarantee minimal losses. These ideas can become the basis for a self-regulating electric grid concept.

Dynamic phase transitions: dynamic melting. In the presence of sufficiently strong pinning, when the applied current exceeds the critical pinning current, the vortex lattice unpins and moves with a plastic liquid-like motion. Further increase of the current, triggers a dynamic phase transition marked by the coherent motion of a periodic vortex structure. The origin of this effect lies in the collisions of a moving lattice with structural inhomogeneities in the material, causing fluctuations in the positions of the vortices, similar to those induced by a finite temperature. This newly discovered fundamental phenomenon occurs in any periodic structure driven through a disordered environment, such as in charge density waves and Wigner crystals and was confirmed by numerous experiments. This so-called *dynamic melting* is critical, to the emerging theory of oscillating and Josephson-like effects in moving flux flow vortex structures.

Non-equilibrium Magnetic Structures. Recently, a theory for non-equilibrium magnetic structures in current carrying superconductors was developed. A particular variant of this theory which addresses dendritic

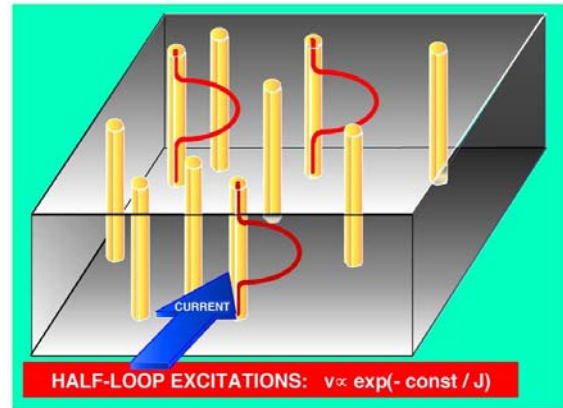

Figure 17 Vortex creep in the Bose glass state: vortex creep at moderate fields where the concentration of columnar defects exceeds the concentration of the vortex lines is controlled by the escape of vortex lines from the columnar traps. The escape occurs via formation of half vortex loops. The corresponding activation barriers scale as const/J , where J is the applied current. Thus columnar defects provide the largest activation barrier and the slowest creep rates achieved so far (all other creep mechanisms due to point defects give rise to the const/J^a , with $a < 1$, creep barrier behavior).

thermomagnetic flux dynamics can have important implications for understanding the stability of ac losses and the current-carrying capability of the second-generation superconductors in the presence of alternating magnetic fields as in motors or generators.

Two gap superconductors

An unusual feature of two gap materials has recently been uncovered. Namely, the temperature dependence of the anisotropy of the upper critical field in MgB_2 differs from the anisotropy of the London penetration depth. This finding contradicts our many-years of experience with other known anisotropic superconductors whose anisotropy is generally temperature independent. Although the phenomenology of the magnetic behavior of two-gap superconductors is still puzzling, significant progress has been made in theories of vortex pinning and the upper critical field in MgB_2 . In particular, MgB_2 alloys offer a unique opportunity to significantly enhance the upper critical field, H_{c2} (up to 70 T by now) by selective atomic substitutions on the B and Mg sites. These recent results indicate the potential of MgB_2 superconductors as the next generation of technologically and commercially viable materials for superconducting wires which could supersede the performance of current conventional wires such as Nb_3Ti and Nb_3Sn .

Mesoscopic superconductivity and hybrid structures

Vortices in mesoscopic and hybrid structures. Superconductors of the size comparable to the coherence length can host exotic vortex structures such as giant vortices. The discovery of a novel fundamental phenomenon, namely the redistribution of the electron density in normal conducting channels of superconductors by an applied magnetic field, offers a new approach to devices for switching/interrupting currents in nanowires. In the *giant vortex state* of nanometer-size disc-shaped superconductors, the conductivity of the central axis of the disc depends on the wavefunction of the core bound states which in turn depends on the number of magnetic flux quanta contained in the disc. This number can be adjusted with unit precision by changing the magnetic field. An odd number of flux quanta drive electrons to the central axis of the disk, making it conducting, while an even number depletes the central axis of electrons, leaving it effectively insulating. Inserting such a disc in a nanoscale circuit creates an ultrafast loss-free quantum current switch controlled by an applied magnetic field. The rate of switching between the insulating/conducting regimes can be as high as $10^{-11} - 10^{-13}$ sec, competing favorably with the best semiconductor devices.

Mixed pairing symmetry and fractional vortices can be realized on crystalline defects such as grain boundaries. Understanding the physics behind the suppression of superconductivity on grain boundaries is critical for applications, where the reduction of strong current-blocking effects due to grain boundaries in high temperature superconductors is of paramount importance.

Electron transport in hybrid structures. Interfaces between different materials are important for nanotechnology since in many cases, interface properties determine the behavior of nanodevices. Recently, a novel mechanism of charge transfer between a superconductor/insulator (S/I) interface was recognized. The mechanism is based on coherent tunneling of electron pairs which converts Cooper pairs in the superconductor to a pair of localized states in the hopping insulator. This mechanism is responsible for a specific contact magnetoresistance. The conversion mechanism gives rise to a specific magnetoresistance of the hybrid S/I contacts and is relevant for transport in granular superconductors. Coincidentally, this effect (which is often called cross Andreev reflection) is responsible for decoherence effects in devices for quantum computations.

Transport in superconductor point contacts. The transport through superconductor point contacts was found to be mediated by the quasiparticle (Andreev) states that form at the very tip of the contact. This permits a quantum pumping device utilizing the spectral flow in a voltage-biased SINIS quantum junction that can be realized via the sequential closing of the minigaps in the energy spectrum in resonance with the Josephson frequency. The dc current exhibits giant peaks at rational voltages.

Layered superconductors

Layered superconductors like Bi-Sr-Ca-Cu-O (BSCCO) exhibit remarkable and unique properties important for their applications in superconducting electronics: (a) Superconductors have very low dissipation providing high

efficiency to all operations needed in receivers, oscillators, emitters, mixers, etc. (b) High-temperature superconductors have a large superconducting gap and hence could be operated at extremely high frequencies with minimum dissipation and thus with very low noise in receivers and mixers. (c) Microscopically identical intrinsic Josephson junctions in single crystals (up to 60000 in a crystal with thickness of 0.01 cm) can be connected in series to form sensitive receivers and emitters. This is difficult to achieve with artificial Josephson junctions.

The following applications were proposed and some are already realized in laboratories: (i) Intrinsic Josephson junctions may be used as mixers and flux-flow oscillators which are essential parts of integrated mm-wave receivers. This was demonstrated in several laboratories in Germany and Japan (but not in the United States). (ii) Crossing vortex lattices induced by magnetic fields tilted with respect to the c-axis represent a complex type of vortex matter comprised of two different components, a set of two dimensional pancake vortices mutually attracted to a set of Josephson vortices. Such lattices may be used in novel vortex logic devices where a stack of pancake vortices can be manipulated by an underlying Josephson vortex and vice versa. (iii) Intrinsic Josephson junctions may be used as a new source of tunable monochromatic and coherent radiation in the hard-to-produce terahertz frequency range. This may be achieved in the flux-flow regime or in the regime of Josephson oscillations in the absence of a magnetic field. The presence of naturally occurring stacks of intrinsic Josephson junctions in BSCCO on the scale of the terahertz radiation wavelength opens a new route for super-radiation. Junctions can radiate coherently with effectiveness (the ratio of the radiation power to that fed into the system) of up to 50%. Likewise, the system may work as very sensitive and economical receivers in the same frequency range. The use of nondestructive terahertz radiation for medical diagnostics and security purposes instead of X-rays is ecological and safe (X-ray radiation damages cells and causes cancer, while terahertz does not) and promises significant energy savings since superconductor-based emitters are more effective energetically than X-ray sources.

Future Developments

The successes and breakthroughs highlighted above in understanding the basic properties of the vortex state of high temperature and, more generally, type II superconductors open new routes for their broad applications in technology and industry. Recent progress in synthesis of new materials and compounds, in which superconductivity coexists with other states of matter (such as anti-ferromagnetism or heavy-fermion electronic systems) established a new and largely unexplored field of basic research, where we expect many new effects and phenomena to be revealed. We discovered the rich fundamental physics of static and current-driven vortex structures in type II superconductors. The important task now is two fold. First, we have to extend our knowledge of artificial nanoscale multilayer structures where superconducting layers can coexist with magnetic, semiconducting or ferroelectric layers and related hybrid structures. Second, new artificial nanostructured materials are a source of emerging physics where we may expect new phenomena to appear. Our basic knowledge in this area can serve as a launch pad for fundamental discoveries in the physics of superconductor-based hybrids and nanodevices that will serve as a pool of ideas for emerging technologies. For example, the recent intensive work on MgB_2 has shed new light on the general phenomenology of macroscopic magnetic properties of two-gap superconductors. Progress in this direction is essential in view of the high-field applications of MgB_2 and for understanding magnetic properties of new and of some existing superconductors which may also have multiple gaps. Another important example are the properties of new emergent materials with programmable properties, *granular superconductors*. Current research has already established new transport regimes and outlined the ways of resolving of one of the puzzles of contemporary physics of superconductivity, the nature of the superconductor-insulator transition. In general, we will deepen our understanding of the effects of pinning and features of vortex dynamics aimed at the ultimate goal of achieving the highest physically possible limit for critical currents of about half the pair-breaking current and, building on present achievements develop a full theory of pinning in the vortex liquid state expanding the useful domain onto the whole phase diagram.

We expect future research to be focused along the following lines:

- *High field superconductors*: Concerning materials perspectives, we could seek for cheaper alternatives to cuprate HTS, and examine whether they are the only players in the 100 T field range. In this respect, it is important to fully explore the high-field potential of dirty two gap superconductors, given the unexpected success of MgB_2 alloys which have already demonstrated their potential for applications in high magnetic fields at temperatures near 20K.

- *Driven non-equilibrium dynamic vortex structures:* We need to deepen our knowledge of the behavior of non-equilibrium dynamic vortex structures driven over a random or periodic pinning potential in the presence of a transport current. New insights in this area will advance our theoretical understanding of the predicted emission of THz radiation in current-driven highly anisotropic layered superconductors originating from the flux flow vortex state. The related emerging direction is the *nonlinear response of superconductors to strong rf fields:* non-equilibrium superconductivity in d-wave superconductors or two-gap superconductors in strong electromagnetic rf fields. Further advances in the theory of non-stationary and transport effects in mesoscopic superconductors will enable the determination of the fundamental limits on emitted THz radiation power in HTS single crystals due to Josephson oscillations and find new ways to increase them.
- *Pinning phase diagram and critical currents:* As new and controlled artificial nano-scale defects become available, it is paramount to develop a theory which could qualitatively and quantitatively elucidate the pinning mechanism of these nanostructured defects and its derived critical current. In particular, the relationship between vortex pinning and current blocking phenomena should be explored which could lead us to determine the optimum concentration of pinning centers that would maximize the critical current. In addition to critical current enhancements, the effect of anisotropy and thermal fluctuations of vortices on the irreversibility field H_{irr} of high temperature superconductors in the limit of strong pinning should be explored. For example, theoretical avenues which could predict an enhancement of H_{irr} through nanostructured defects and could lead to a reduction in the pinning anisotropy will certainly be appealing to superconducting cable applications. Recent studies showed that strong pinning sites can induce superconducting islands even in the vortex liquid phase (this possibility was considered unthinkable just five years ago). This opens potential routes to utilize superconducting properties of high temperature superconductors in the high temperature – high magnetic field domain of the phase diagram. The full description of the electromagnetic response of superconductors in this novel intermediate vortex liquid state is still waiting to be constructed and explored. These studies will promote discussions on how high the critical current density, upper critical field and irreversibility field could be expected in a putative room temperature superconductor.
- *Glassy states:* One of the most important tasks is to achieve a full understanding of the vortex glassy states, aging and memory effects in disordered superconductors and hybrid structures and to utilize the basic properties of glasses for applications. The investigations need to focus along the two lines of: (i) developing the emerging theory of aging and memory effects and (ii) deepening our knowledge of vortex creep dynamics. There is an impressive advance in the latter topic: it is important not only to raise the upper limit of critical current but to maximally suppress the inevitable thermally activated creep motion which leads to losses. It was shown that the best effect in creep suppression can be achieved by the introduction of correlated defects and the formation of the Bose glass state. Recent theory has predicted that the same effect can be achieved by transforming a crystalline vortex lattice into an *amorphous vortex glass*, by either increasing the density of point defects or by increasing the magnetic field. In the amorphous glass state, vortex creep is realized by dislocation motion and is as slow as creep in the Bose glass state. Finding new ways to optimize the transport properties of the superconductor glass state by combining the action of defects with different geometries with the related effects of vortex structural transitions is critical to applications.
- *Designing new superconducting materials with programmable properties based on granular superconductor.* There is a new emerging class of materials with tunable electronic properties, granular superconductors, which can be driven between the insulator and superconductor state, changing their conductivity by orders of magnitude by tuning the applied magnetic field. Recent research shows that small spherical granules of specific size can exhibit anomalously high superconducting transition temperature. Thus granular superconductors can offer an alternative way to the design of room temperature superconductors.

- *Nanostructured devices based on Andreev state-mediated transport:* Superconducting point contacts are expected to be one of the main building units for any superconductor-based nanodevices. It was recently shown that the transport in these devices is mediated by normal Andreev excitations in direct analogy to the dissipation mechanisms within the vortex core. Recent studies have already revealed several novel effects specific to superconducting point contacts, in particular, mesoscopic fluctuations of the transmitted current and pumping effect. There is a wide class of related phenomena in hybrid structures utilizing various spin transfer phenomena (like the Kondo effect). Utilization of this emerging science for applications will require a large-scale research on transport phenomena in mesoscopic superconductors and hybrid structures.
- *Research on noise and decoherence effects* which is crucial for quantum computing and all other technological application of nanostructured superconducting and hybrid structures.
- *Deepening the basic phenomenological description of the vortex state:* The London theory, employed as a foundation for vortex physics at temperatures well below T_c often fails to describe many low-temperature phenomena (like superconducting screening) with the necessary quantitative precision. While a full-blown microscopic approach to describe vortices is too complex and can be implemented only in conjunction with massive numerical calculations that often do not provide a qualitative insight to direct the experimental research, a more promising direction may be a semi-microscopic approach. In particular, the field dependence of the coherence length obtained via microscopic calculations can be incorporated into the London theory (indications of the existence of this dependence appeared in recent μ SR and neutron scattering data). This approach may become a basic advance in theoretical phenomenology and the key technique to the search for new effects and potential applications.

EXAMPLES OF THEORETICAL ACCOMPLISHMENTS

The past 20 years have witnessed important theoretical contributions to superconductivity across a range of materials and mechanisms from the cuprates to the borides, ruthenates and other systems, regarding the roles of strong lattice distortions, electron correlations, Fermi surfaces, new phases of matter and new symmetries of the order parameter. Taken as a whole, these advances have profoundly deepened our understanding of the richness and diversity of the superconducting state, and have widened the scope of opportunity for both understanding and improving the properties of known superconductors and guiding the search for new ones. Below we list some cases of successful applications of the theory of superconductivity since the discovery of high T_c . These are just selected examples, with no claim of even near completeness.

- ***d-wave superconductivity.*** Calculations based on spin-fluctuation mechanism, as well as Gutzwiller variational calculations lead to theoretical predictions of $d(x^2-y^2)$ superconductivity in the cuprates before it was established experimentally. The phase sensitive tunneling experiments were suggested by theorists (originally for heavy fermions) were later implemented and have provided the ultimate proof of the d-wave pairing symmetry
- ***Stripes.*** Early Hartree calculations found evidence for charge separation and striped states in doped t-J and Hubbard models, no one of the central issue in physics of cuprates.
- ***First principle calculation.*** Materials specific calculations have provided accurate Fermi surfaces and other key properties of many superconductors, including cuprates, ruthenates and various electron-phonon superconductors in advance of experiment. This enables microscopic understanding of superconducting materials, the roles of electron correlations, electron-phonon coupling and lattice distortions.
- ***Material predictions.*** It was suggested theoretically that the T_c of $\text{BaPb}_x\text{Bi}_{1-x}\text{O}_3$ could be raise dramatically if doped with K instead of Pb and $\text{Ba}_{1-x}\text{K}_x\text{BiO}_3$ was found to have a T_c in excess of

30K. Numerical studies showing pairing correlations on 2-leg t-J ladders were published prior to the discovery of the $(\text{SrCa})_{14}\text{Cu}_{24}\text{O}_{41}$ 2-leg cuprate material. Superconductivity in nanotubes had been predicted theoretically well before its experimental discovery. Several materials were successfully predicted to superconduct under pressure, including Li, currently the highest- T_c elemental superconductor.

- **Multigap superconductivity** in MgB_2 was theoretically predicted and soon confirmed. Most unusual properties of this material are now understood in framework of this theory. Superconductivity in doped fullerenes is another example of a successful and rather complete microscopic theory of an unusual superconductors.
- One of the very first experimentally verified theoretical predictions was the prediction of the nonlinear **vortex creep**. This prediction has led to experimental observation of the predicted vortex lattice melting. The theory of vortex creep then served as a basis for the nonlinear electrodynamics of strongly inhomogeneous superconductors in the vortex state.
- **Bose-glass theory**. Enhanced pinning, low temperature Bose-glass phase, specific variable range vortex hopping transport and the upward shift of the irreversibility line were predicted to result from the artificially manufactured columnar defects. All these effects were found experimentally.
- **Vortex phase transitions**, such as dynamic melting, were predicted and subsequently observed experimentally. Other confirmed theoretical predictions include decoupling transition, crossing lattices and Josephson plasma resonance in high- T_c superconductors.
- As an example of a theoretical accomplishment in applied superconductivity, theoretical calculations for thin film HTS **microwave filters**, have determined the temperature dependence of the intrinsic non-linear response which presently limits the power handling capacity of such filters.

FURTHER READING: THEORY

1. J. Bardeen, L.N. Cooper, J.R. Schrieffer. "Microscopic Theory of Superconductivity." Phys. Rev. **108**, 162 (1957).
2. V.L. Ginzburg. "Nobel lecture, Sec. 3: On high-temperature and room-temperature Superconductors." Rev. Mod. Phys. **76**, 981 (2004).
3. A.J. Leggett. "What DO we know about high T_c ?", Nature Physics, **2**, 134 (2006).
4. W.E. Pickett. "Design for a Room Temperature Superconductor." Submitted to V. Ginzburg commemorative volume of the JLTP. cond-mat/0603482; "The Next Breakthrough in Phonon-Mediated Superconductivity." Submitted to proceedings of the Notre Dame Workshop on the Possibility of Room Temperature Superconductivity, June 2005. cond-mat/0603428.
5. P.W. Anderson. "Present status of the theory of the high T_c cuprates." Submitted to V. Ginzburg commemorative volume of the JLTP. cond-mat/0510053
6. P.A. Lee, N. Nagaosa, X.G. Wen, "Doping a Mott insulator: Physics of high-temperature superconductivity," Rev. Mod. Phys. **78**, 1 (2006).
7. A.A. Golubov, M.Y. Kupriyanov, E. Il'ichev. "The current-phase relation in Josephson junctions." Rev. Mod. Phys. **76**, 411 (2004).
8. A.I. Buzdin, "Proximity effects in superconductor-ferromagnet heterostructures," Rev. Mod. Phys. **77**, 935 (2005).

9. M.R. Norman, C. Pepin, "The electronic nature of high temperature cuprate superconductors," *Rep. Prog. Phys.* **66**, 1547 (2003).
10. I.I. Mazin and V.P. Antropov, "Electronic structure, electron-phonon coupling, and multiband effects in MgB_2 ," *Physica C*, **385**, 49 (2003).
11. G. Blatter, M.V. Feigel'man, V.B. Geshkenbein, A.I. Larkin, V.M. Vinokur, "Vortices in high temperature superconductors," *Rev. Mod. Phys.* **66**, 1125 (1994)
12. J. Kierfeld, V. Vinokur, "Lindemann criterion and vortex lattice phase transitions in type-II superconductors," *Phys. Rev.* **B69**, 024501 (2004)

Energy Related Applications for Superconductors

BACKGROUND

Conductors for the electric utility power sector have emerged as the dominant research need of the community. In the decade following the discovery of high-temperature superconducting (HTS) cuprates, extensive international research efforts led to the discovery of several classes of the materials with various ranges of T_c and the acquiring of a broad phenomenological understanding of their structural and electronic properties. While development of these materials was being pursued for different technologies, including thin film superconducting filters for wireless communications and tunnel devices for superconducting electronics, for both economic and technical reasons the strongest driver has emerged to be the needs of the utility electrical power sector. In the various high-current devices of this technology, superconducting wires could potentially provide substantial gains in efficiency, capacity, size and weight, power quality and grid reliability. By the mid-1990's, in the face of many formidable problems, pathways to the development of viable HTS wire technologies were starting to be realized.

In this section, the motivation for and status of this thrust is outlined, including a brief description of the advances in materials properties that have contributed to the present approaches to HTS wires. Finally, the status of commercial wire development and applications is described, including several national projects aimed to demonstrate near full-scale functionality in practical implementation.

THE NEED FOR SUPERCONDUCTING TECHNOLOGY

Electricity demand in the US continues to grow at a rate of about 2.3%/year, and tracks closely with the overall growth of the economy (GDP). The fraction of total energy consumed in the form of electricity also has steadily increased to about 40% presently, and is poised to reach as much as 70 percent. In 2004, net electric utility energy production was almost 4000 TW-h, while losses associated with power transformation, transmission, and distribution approach 8% (10% on the grid). These losses could be cut approximately in half, amounting to >\$10B in savings, with the full implementation of superconducting technology, including underground transmission cables, transformers, power-quality devices, and fault-current limiters.

Superconductivity enables an advanced conductor, a complement to multiple other “critical” technologies that will contribute to the more efficient, reliable and secure electrification of American society. These other technologies will encompass both evolutionary and revolutionary advances, and require integration with superconducting devices wherever appropriate. Possible synergy occurs in such areas as distributed energy sources, improved automation for “self-healing” and optimization of transmission systems, power electronics for improved delivery control and improved compatibility with DC transmission, computer modeling, control and communications in the assessing and porting of energy flow.

THE GRID AS A FOCUS

Power Consumption as the Problem. The widespread power outage of August 2003 in the Midwest, Northeast, and portions of Canada underscored the growing vulnerabilities in the US electrical grid. Over the past 15 years or so, as both demand and generation capability have increased, investment in modernized transmission and delivery systems has languished, see Fig. 18. The DOE-sponsored “National Electric Delivery Technologies Roadmap” of January 2004 drew on the input of 250 electricity industry professionals to help identify key issues for a modernizing the grid. Among the conclusions, “*The ‘technology readiness’ of critical electric systems needs to be accelerated, particularly for high-temperature superconducting cables and transformers, ...*” Indeed, this recognition by industry practitioners of the role of superconductivity in a long-range solution is significant, and in step with the strong focus by DOE and industry on the demonstration of prototype HTS cables for practical underground electrical delivery.

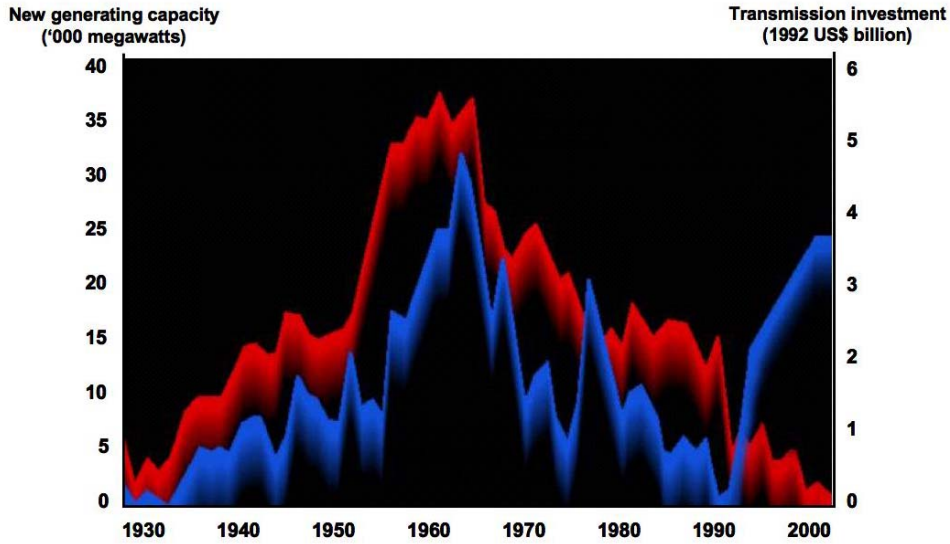

Figure 18 Comparison of new generation capacity (blue) and transmission investment (red) over time. Disparity in the 1990-2000 time frame is telling...any reserve transmission capacity is being used up at an alarming rate.

Superconductivity as the Solution. Presently, the development of high-temperature superconducting cuprates in the form of tape conductors has matured to a level sufficient for three power distribution and transmission projects, as joint ventures among government, utilities, and cable and wire manufacturers. These cables will be operating in liquid nitrogen at 68 - 80K, and have the potential to deliver 3 – 5 times the power as conventional copper cables operating in the same size conduit. Some designs for HTS cables can transport all three phases in a very compact, coaxial arrangement as shown in Fig. 19.

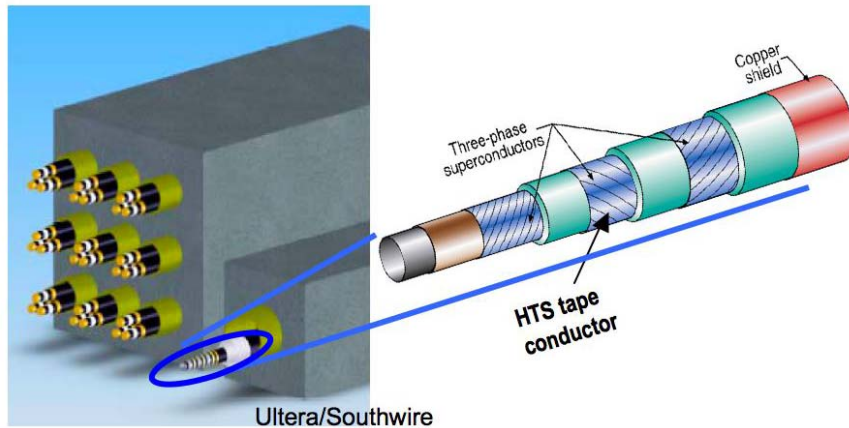

Figure 19 Schematic comparison of the 3x3 duct bank of an underground copper distribution system compared to one triax HTS cable operating at 13kV and transferring 69 MVA of power.

Demonstration underground cable projects

One above-ground facility has already been operating since February 2000. This 30m long, 3-phase 12.5kV system uses the BSCCO-based 1G conductor, and has provided 100% of the load for operation of the Southwire Company plant in Carrollton, Georgia. Building on this success, three new projects, transporting underground power for “real-world” demonstrations, are underway and scheduled for completion no later than 2007.

- Where: Holbrook substation, Long Island Power Authority, Long Island, NY.
Wire manufacturer: American Superconductor Corp.; 1G wire
Cable manufacture: Nexans Cable Co., E.U. (France).
Specifications: 610 m long (155 km of wire); 138 kV; 2400A; 574 MVA
- Where: Bixby substation, American Electric Power Co., Columbus, Ohio.
Wire manufacturer: American Superconductor Corp., Westborough, MA; 1G wire
Cable manufacture: Ultera/Southwire, Carrollton, Georgia and E.U. (Denmark)
Specifications: ~200 m long w/90 degree bends; 13.2kV; 3000 Arms AC; 69 MW
- Where: Riverside to Menands substations, Niagara Mohawk Power Co., Albany, NY.
Wire manufacturer: Sumitomo Electric Industries, Japan; 1G wire. SuperPower Inc.; 2G wire
Cable manufacture: Sumitomo Electric, Japan
Specifications: ~350 m long w/90 degree bends (30m length w/2G wire); 34.5kV; 800Arms AC

OTHER APPLICATIONS OF HTS CONDUCTORS

Through the same Superconductivity Partnership Initiative (SPI), DOE has co-sponsored the construction and operation of other prototype superconducting power equipment. To date, these have included,

- Superconducting motors: 1,000 and 500 horsepower prototypes as part of a DOE SPI program led by Rockwell Automation. Superconducting motors promise half the size, weight, and energy losses of conventional large motors, while operation of the HTS in magnetic fields of 2 – 5 Tesla is expected. The use of 1G wire necessitates operation near 30K. Progress using 1G wire has contributed to the successful fabrication of HTS-based motors and generators for ship propulsion, with a 4 MW generator built by Siemens, and with a 5 MW motor built by American Superconductor under a US Navy contract, followed by a 36.5 MW motor nearing completion.
- Transformers: Superconducting transformers are expected to result in a 30% reduction in losses, ~1/2 weight and footprint of a conventional unit, and oil-free operation for possible placement inside structures. Efforts to develop HTS transformers have predominantly focused on using present-day steel cores and substituting HTS wire for the conventional copper conductor. Although the size of the transformer is mostly determined by the size of the core, the higher current density of the HTS wire does lead to a decrease in total size and weight. It is possible that the HTS transformer could be designed with integral fault current-limiting features (see following section) The DOE SPI program has been led by Waukesha Electric Systems, Waukesha, WI.
- Fault current limiters: Superconductors are unique materials for applications in fault current limiters, because they have zero resistivity in their superconducting state and quite high resistivity in their normal state (much higher than ordinary metals, such as e.g. Cu or Al). It is also necessary for the sample to warm above the critical temperature in the first cycle (i.e. to limit the inrush current) without burnout in the later cycles, which requires careful design of the element. To protect the superconductor when in the normal state, a normal metal layer or matrix is used as a shunt, with a design that combines the needed resistance and geometry to both limit the current and protect the superconductor. Along with reduced cost and rapid response; superconducting FCL should reduce fault currents from 10-20 times rated to 3-5 times rated current. The DOE SPI programs have been led by General Atomics and IGC SuperPower.

- **Synchronous Condensers:** These devices operate somewhat like a motor or generator without a real power source, and either provide or absorb reactive power. An 8 MVAR machine industrially funded and produced by American Superconductor Corp. has been tested for a year on the Tennessee Valley Authority grid and TVA has ordered the first two commercial 12 MVAR units, which are under construction. Thus the synchronous condenser is the first commercial power equipment based on HTS wire.

CLASSICAL NB-BASED SUPERCONDUCTORS

After over 50 years of attention, low-temperature superconductor (LTS) wires ($T_c < 18\text{K}$) continue to serve as sources of high magnetic fields in a number of devices. Perhaps most significantly, LTS materials constitute the single largest commercial market for superconductors, as medical imaging magnets for MRI systems. The MRI solenoid magnets generate fields in the range 0.5 – 2.0 Tesla (fields greater than 2 Tesla have not been approved for use in medical imaging). The United States leads a global market of about \$2B annually in MRI magnets, which are made with Nb-47%Ti wire. The present annual wire production for this purpose is about 1,000 metric tons, which is the approximate equivalent of the entire wire procurement for federal research projects. As a point of reference for the later discussion of HTS wire cost, NbTi wire is produced for about \$1/kA-m (at 5 T and 4.2 K).

Other uses of LTS wires include advanced particle accelerator magnets at 12 to 20 tesla fields, magnets for the International Thermonuclear Experimental Reactor (ITER), and research-oriented nuclear magnetic resonance (NMR) magnets at 20 to 25 tesla. For these applications, the present material of focus is Nb₃Sn, for which the critical current density has doubled since about 1998, to ~1500 A mm⁻² over the entire strand area at 12 T and 4.2 K. Issues for continued development of LTS wire include managing flux-jump instabilities that locally heat the material, reducing the superconducting filament size for AC losses, and scaling up the production billet size to lower costs. ITER's procurement of 600 metric tons of Nb₃Sn strand, at an approximate cost of \$1,000 per kg, will dominate global production for the next 5 years. Wire made for ITER, for which current density is limited to manage losses, costs about \$25 per kA-m; some accelerator magnet strands with much higher current density cost slightly less than \$6 per kA-m at 12 T and 4.2 K.

1st GENERATION (1G), BI-BASED HTS CONDUCTORS

Although the cuprate HTS materials are extremely complex, and their properties present several serious obstacles to the development of wires, many of these problems have been solved, and 1-km lengths of composite wire based on BiSrCaCuO superconductors (BSCCO) are routinely produced by companies in the United States and Japan, China and Europe. These wires, which are actually multi-filament composite silver/superconductor ribbons, are formed by loading a powder of BSCCO precursor into a silver or silver-alloy tube, which is then sealed and drawn into a fine wire. These segments are cut and re-stacked for a series of additional drawing, rolling and heat-treatment steps, leading to the final multi-filament oxide-powder-in-tube (OPIT) tapes as shown in Fig. 20a which are commonly referred to as first generation (1G) wires. The silver matrix (~60% of the material in the wire) is chemically compatible with BSCCO, and endures the necessary high-temperature processing in oxygen. The fine BSCCO filaments, ~100 μm wide by only a few μm high, tolerate an acceptable amount of bending, like the fine glass filaments in flexible fiber-optic cables. Most importantly, the processing aligns the crystalline BSCCO grains within a filament, so that the *c* axes are roughly perpendicular to the tape plane (to within 10–15°). Within a filament, electric currents can thus flow from one highly anisotropic grain to

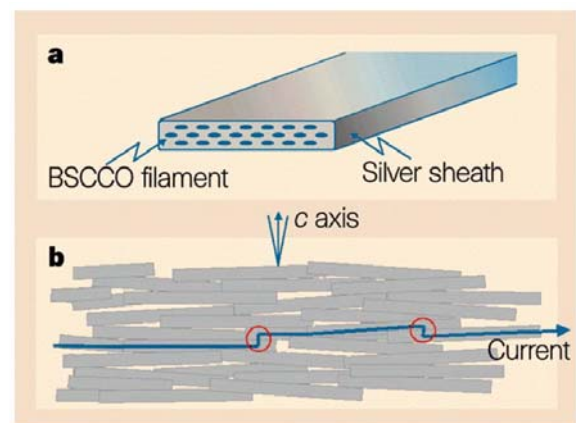

Figure 20 Sketches of (a) a standard 1G industrial superconducting tape, with 'BSCCO' filaments embedded in a matrix of silver, and (b) the cross-section of a single BSCCO filament, tracing a flow of current through the assembly of crystalline grains.

another predominantly within the CuO₂ sheets as shown in Fig 20b, while transfer between grains takes advantage of the large geometric grain overlap that distributes the weak *c*-axis current over large areas. This so-called “brick wall” structure of 1G wire filaments is central to its success, since many basic studies have shown that supercurrent transport across a grain boundary can be greatly suppressed for misalignments greater than a few degrees (the “weak link” effect). This is true even for the case where the *c* axes are perfectly parallel, and the adjacent crystals are merely misaligned in-plane, so-called [001] tilt-grain boundaries. This handicap is intrinsic to HTS because of their low carrier density, short coherence length and strong sensitivity to structural disorder.

At this time there is no feature of OPIT tape processing that can lead both to *c*-axis and to in-plane grain alignment. Such biaxial alignment would give long conductors single-crystal-like properties; this is the approach being developed for 2G, YBCO-based wires.

2nd GENERATION (2G), YBCO-BASED CONDUCTORS

Characteristics Early in the investigations of HTS materials, it was realized that epitaxial, single-crystal thin films of YBCO, deposited by a range of techniques, could support large critical current density, even in the presence of strong applied magnetic fields. Fundamental studies revealed that among all the HTS cuprate material classes, YBCO shows the lowest intrinsic electronic anisotropy, as characterized by the supercarrier effective mass ratio, $\gamma = \sqrt{m_c / m_{a-b}} \approx 5 - 6$. A large anisotropy drastically weakens the pinning effect that comes from nanoscale material disorder. On a quantitative scale, YBCO is perhaps 30 - 50 times less anisotropic than BSCCO, in which the CuO₂ sheets are so weakly coupled that the electronic response is nearly two-dimensional. Thus, YBCO has intrinsically better in-field current conduction at temperatures above $\sim 1/2 T_c$, although both conductors have excellent high-field characteristics at lower temperatures (below about 35 K for BSCCO). The challenge for YBCO is to overcome the weak-linked inter-grain currents, which otherwise suppress current at all temperatures. This has been done, an achievement that has led to the development of 2G “coated conductors.”

In contrast to the 1G wires formed by relatively standard metallurgical procedures, the 2G conductors require epitaxial growth of a thin YBCO layer on a nearly single-crystal structural template on kilometer-length metal tapes. Presently, in the US there are two approaches to obtaining such a functional substrate, as shown in Fig. 21. A decade of research and development has been required to discover and optimize the multilayer buffer heterostructure that provides both structural and chemical compatibility between the HTS coating and the underlying Ni-alloy metal tape as well as to improve the texture to near-single-crystal levels.

After the initial discovery of the IBAD process for an HTS coated conductor at Fujikura in 1991, the two methods were developed and refined in the mid-1990's at the US national labs, IBAD at Berkeley and LANL and RABiTS at ORNL. These are subsequently being implemented by SuperPower Inc. and American Superconductor Corp., respectively.

The IBAD template

By improving a technique first used by Fujikura of Japan, in 1995 LANL announced record performance of highly biaxially-textured YBCO deposited by pulsed laser deposition. This was enabled by an IBAD layer of yttria-stabilized zirconia (YSZ), $\sim 1\mu\text{m}$ thick, on a polycrystalline Hastelloy tape. By extending the process to MgO, Stanford and LANL have decreased the time for grain alignment by a factor of 100. In this case, texture is achieved after only about 10nm of vapor deposited MgO on an electropolished and amorphous-oxide seeded metal surface. The IBAD layer is induced to grow biaxially aligned with the $\langle 001 \rangle$ axis up, and the $\langle 110 \rangle$ MgO crystalline axis directed along the Argon ion beam, oriented 45° from the tape normal. Subsequent buffer layer(s) are then deposited epitaxially to provide a structural template for YBCO, and to act as barriers against in- and out-diffusion of chemical contaminants. Excellent substrate grain alignment distributions (full width at half maximum) of $\sim 4^\circ$ in-plane and $\sim 2^\circ$ out-of-plane are achieved in short length metal tapes.

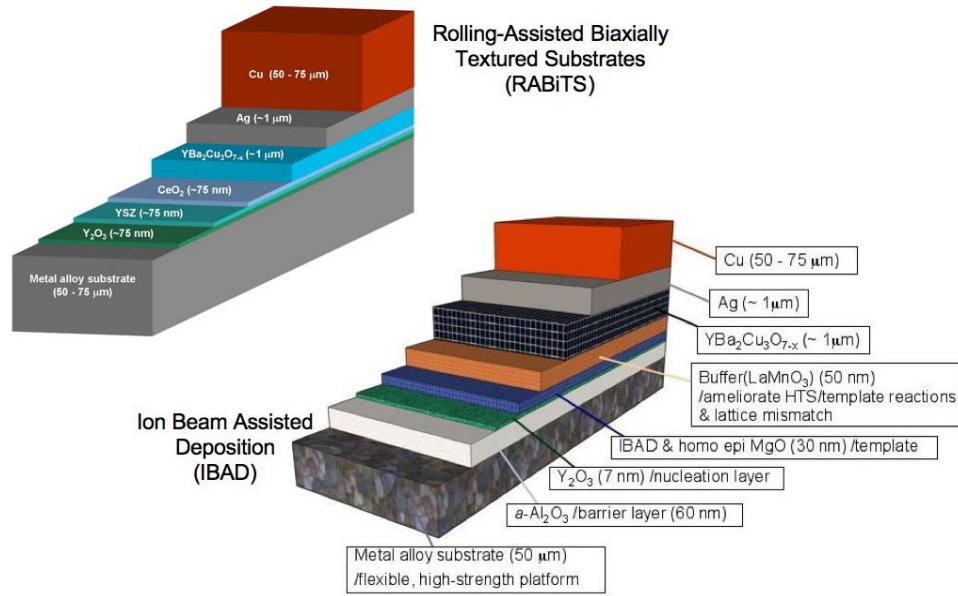

Figure 21 Schematics of the epitaxial multilayer heterostructures that comprise 2G “coated conductors.” The RABiTS and IBAD techniques are the two approaches being pursued by US industry to yield a near single-crystal YBCO coating needed for high-current performance.

The RABiTS template

In this approach, the nickel-alloy tape (usually Ni-W) itself is rendered highly biaxially textured by well-defined thermomechanical rolling deformation, followed by annealing. Resulting texture in the fcc metal corresponds to cube planes parallel to the tape surface and perpendicular to the tape long axis. The resulting RABiTS template shows x-ray orientation distributions of $5 - 7^\circ$ FWHM in- and out-of-plane, while the grain-to-grain distribution, relevant to inter-grain currents, is somewhat tighter at $\sim 4^\circ$. As shown in Fig. 21, presently a three-layer buffer stack is grown epitaxially on the textured metal tape by PVD processes for chemical and structural compatibility. A key to RABiTS functionality is the epitaxial growth of the first, or seed, buffer layer on the reactive metal surface. Careful surface studies helped identify and control an ordered, half-layer of sulfur on the metal surface that apparently mediates the epitaxial nucleation of the commonly used CeO_2 or Y_2O_3 seed layer.

The 2G HTS Coating. For either type of template, the near single-crystal like YBCO layer can be deposited using vapor deposition (e.g., electron-beam or thermal evaporation, pulsed laser deposition, or metal-organic chemical vapor deposition) or wet chemical processes (metal-organic decomposition -MOD). World-wide, all three methods are being pursued commercially, while in the US SuperPower Inc. is developing MOCVD and American Superconductor Corp. the solution-based technique. These two general approaches can be distinguished as *in situ* and *ex situ*, respectively. In the case of MOCVD YBCO, temperature and ambient gas environments are closely controlled as the substrate tape passes reel-to-reel through the reaction chamber and the HTS layer is grown epitaxially. For the solution approach, a precursor chemical mixture is “dye-coated” onto the moving substrate at room temperature; then, in a second step the YBCO is grown while passing the precursor-coated tape through the controlled environment of a furnace. Finally, for stability against burnout in the event of a transient condition, a thin layer of silver and a thicker copper shunt are applied. The details of these additional layers depend on the intended application parameters (temperature, field), but limit the overall, engineering current density, J_e , that is central to the design of electric power equipment.

2G Performance Status. Because the 2G technology has nearly eliminated the problem of weak inter-grain coupling, the present focus has turned to issues of economic scale up by the companies and optimization of flux pinning in the HTS coating. The significance of the latter may be understood by considering that the $1 - 3 \mu\text{m}$ thick HTS layer comprises a very small fraction (possibly only 1–2%) of the entire coated-conductor architecture. 2G

conductors have now been demonstrated in the United States, Japan and Germany in 100-200-m lengths. At typical total HTS tape dimensions of ~4mm wide x 100 – 300 μm thick, the 2G critical current levels of ~50-100A in these lengths are only about half those of 1G BSCCO at the benchmark conditions of 77 K, self-field. The high 1G values can be ascribed to the approximately 40% fill factor and a larger thickness of the 1G tapes, but underscores the need to fully optimize the YBCO coating to achieve the maximum performance with the minimum amount of material. Recent progress on short research samples has been impressive, including advances in tailoring the flux pinning nanostructure and approaches to ameliorate the longstanding problem of a progressive reduction in the critical current density with HTS coating thickness. An important next step is to extend the short sample findings to obtain comparable properties using practical reel-to-reel HTS deposition processes.

Research and Development Goals

Through a series of workshops, DOE has established out-year goals for the performance of 2G wire in order to meet the needs of the electric power sector. Goals for tape fabrication for the next four years are in response to specific research thrust areas:

- Maximizing critical current is essential
 - 300-A/cm-width (77K, H=0), 100-m by 2006
 - New (proposed): 200A, 4.4-mm wide, 3-T (H||c), 65 K by 2008
 - 1000-A/cm, 1000-m (77 K, H=0) by 2010
- 5% or less variation in properties along the wire length
- Current proportional to HTS thickness

A perspective on these goals and present performance levels can be seen in Fig. 22.

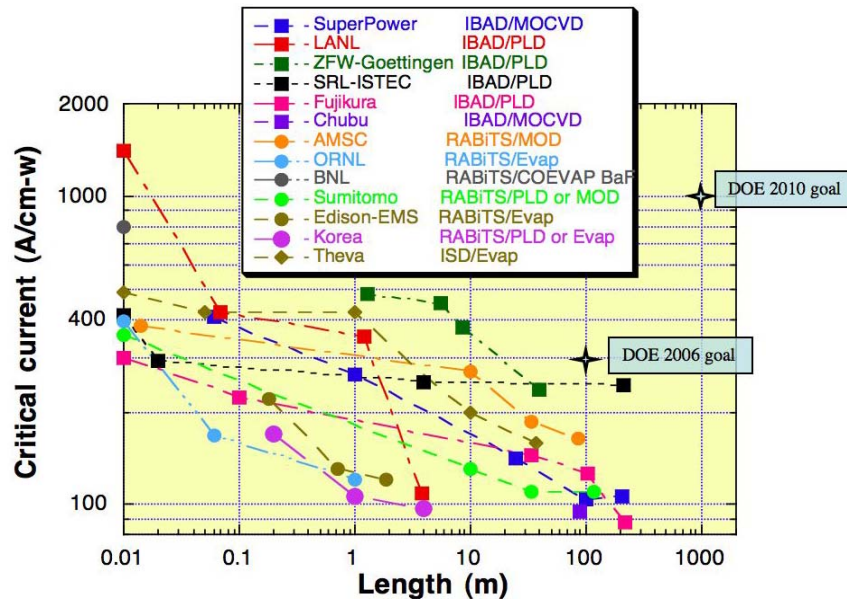

Figure 22 Performance levels of prototype 2G conductors (August 2005). The metric plotted is the critical current per unit width of tape, measured at 77K in self field. As piece-lengths are increased, the current levels decrease, a problem to be solved in approaching the indicated DOE goals.

OTHER NOVEL WIRE: MgB₂

Following the recognition that the simple intermetallic compound MgB₂ was a 39K superconductor and that interesting physics arises from its two-band electronic structure, the material is also progressing towards practical uses. Most significantly, strong impurity scattering within boron σ , and π bands can lead to dramatically enhanced upper critical fields. This expanded field capability along with a decrease in H_{c2} anisotropy makes MgB₂ potentially well suited for magnet applications at ~20 K, where HTS conductors presently are without challenge. Following is a brief summary of the development status.

MgB₂ Formation Issues. Magnesium diboride formation is a prime topic for basic materials science research. Although a vast literature exists dealing with the preparation of MgB₂ films, bulks, and wires by physical- and chemical-vapor deposition techniques and by the reaction of mixed powders, little is known about the details of the solid-phase Mg+B \rightarrow MgB₂ formation process - e.g. reaction mechanism and kinetics, influences of particle sizes and the form of the starting boron (crystalline vs. amorphous), the effect and disposition of dopants, and the existence of intergranular phases. The results of basic materials science studies of these issues underly the eventual application of MgB₂ as a practical intermediate-temperature superconductor.

Material Characteristics. The upper critical field, H_{c2} , of MgB₂ can be raised from 16 T to 35 T by the addition of about 4% carbon replacing boron. This lowers T_c from 39.2 K to about 35 K so a magnet operating temperature of 20K is quite feasible. Here, H_{c2} (20 K) =15 T for a polycrystalline material. For the pure material, grain boundary pinning seems to control J_c so a grain size in the range of 0.1 to 1.0 μm is preferred. The coherence distance, ξ , ranges from 1 to 5 nm, so precipitates to effectively enhance J_c by core pinning are usually of this size. Dispersions of SiC, TiB₂, and Y₂O₃ have been used successfully to raise J_c . An important feature that distinguishes MgB₂ from cuprate HTS materials is the very strong superfluid coupling across a full range of grain boundary misalignments making polycrystalline conductors quite feasible.

Powder-In-Tube Fabrication. A continuous tube filling and forming process that has been developed at Hyper Tech Inc. has successfully fabricated dozens of 1 km lengths of [MgB₂-Nb-Cu-CuNi] conductor suitable for superconducting magnets, though critical fields are still well below those obtained in laboratory material. A wide variety of powder mixtures can be inserted into the Nb sheet as it is rolled into a channel and then rolled closed with an overlap layer of Nb. A typical reaction procedure to form MgB₂ is heat treatment at 700°C for 20 minutes.

Performance Typical performance is J_c (20 K-2 T) = 150 kA/cm² with a strain tolerance of 0.3%. Demonstration coils with 3.8 cm bore and 5.3 cm coil height have produced bore fields of 2.4 T at 20 K. The engineering J_c value of this coil is 15,000 A/cm².

AC LOSS ISSUES

Aside from possible DC transmission, in practice all superconductors will be operating in an “AC environment” and hence will experience AC loss by various mechanisms depending on the application. The composite coated conductor will experience hysteretic loss under the action of the transport current's self field or some kind of “external field.” AC loss can arise in the form of eddy-current loss in the composite's normal components, substrate (underlayer) and overlayer. The hysteretic loss, proportional to the conductor's width projected normal to the applied-field direction, can be reduced by “striping,” i.e. subdividing the tape into numerous narrow stripes, for example by laser ablation. But accompanying striping, as with all forms of filamentarization, is the possibility of coupling loss moderated by eddy-current-like paths that embrace the stripes and the intervening matrix material. Coupling loss is controlled by twisting and adjusting the effective transverse matrix resistivity.

Taken together, these AC-loss issues call for innovations in tape architecture and stack placement (in the case of multitem windings) especially as some future applications may call for higher frequencies of operation.

THE COST ISSUE

Cost targets for HTS wire are set by the direct competition with room-temperature copper for many utility power applications. Presently, these levels for copper wire are in the range of \$30/kA-m of wire, for the case of head-to-head comparisons in transmission line operation, with the HTS at 77K. An expected advantage of 2G wire is a 5-fold decrease in the price compared with first generation wires, when considering the high fabrication and materials costs of the silver-clad BSCCO tapes. To achieve this target, costs of the relatively complex equipment needed for this 2G deposition-based technology need to be counterbalanced by high performance levels and high production rates. By the end of 2007, American Superconductor Corp. projects pilot-plant 2G production of 720 km/year, while SuperPower, Inc. anticipates achieving throughput rates of 90m/h during production of 4mm wide tape by mid 2006. The importance of superconductor performance cannot be understated, since a factor-of-two increase in the critical current translates directly to a 2x reduction in cost/kA-m of wire. Presently, the 50 – 200m lengths of 4mm wide 2G tape perform at current levels ~100A. The expected transference of the short-segment properties to 100 m lengths will be over a 3 - 4 year time period and should raise the performance by factors of 3 – 5 (see the goals of Fig. 22). To illustrate, in three years ~100A tape lengths have been increased from 1m to 100m at SuperPower Inc. In the near term, it is expected that annual production rates of 1000 km will be required to completely supplant 1G wire. These levels and beyond would come through investments in full-scale production facilities, capable of >8000 km/y, presuming the emergence of the HTS utility markets that have been estimated at ~\$1.8B/year within the next 20 years.

FURTHER READING: APPLICATIONS

1. John R. Hull, "Applications of high-temperature superconductors in power technology," Rep. Prog. Phys. **66**, 1865 (2003).
2. Ronald M. Scanlan *et al.*, "Superconducting Materials for Large Scale Applications," IEEE **92**, 1639 (2004).
3. "Remote Energy By Wire: Pathway To A More Secure Energy Future," http://www.amsuper.com/documents/SecEnrgFutWhitePaper_rv10_18.pdf
4. "Analysis of Future Prices and Markets for High Temperature Superconductors," <http://www.ornl.gov/sci/htsc/documents/pdf/Mulholland%20Appendices%20Rev%20063003.pdf>
5. C.W. Gellings and K.E. Yeager, "Transforming the electric infrastructure," Physics Today **57**, 45 (2004).
6. A. Gurevich and E.A. Pashitskii, "Current transport through low-angle grain boundaries in high-temperature superconductors," Phys. Rev. B **57**, 13878 (1998).
7. U. Schoop *et al.*, "Second Generation HTS Wire Based on RABiTS Substrates and MOD YBCO," IEEE Trans. Appl. Superconductivity **15**, 2611 (2005); <http://www.amsuper.com/products/htsWire/2GWireTechnology.cfm>
8. V. Selvamanickam *et al.*, "Scale Up of Applications-Ready Practical Y-Ba-Cu-O Coated Conductors," IEEE Trans. Appl. Superconductivity **15**, 2596 (2005); <http://www.igc.com/superpower/pdfs/2GHTSSpecSheet.pdf>
9. Paul N. Arendt and Stephen R. Foltyn, "Biaxially textured **IBAD**-MgO templates for YBCO-coated conductors," MRS Bulletin **29**, 543 (2004); A. Goyal *et al.*, "The RABiTS approach: Using rolling-assisted biaxially textured substrates for high-performance YBCO superconductors," MRS Bulletin **29**, 552 (2004).
10. C. Cantoni *et al.*, "Quantification and control of the sulfur $c(2 \times 2)$ superstructure on $\{100\}/\langle 100 \rangle$ Ni for optimization of YSZ CeO₂, and SrTiO₃ seed layer texture," J. Mater. Res. **17**, 2549 (2002).
11. M.D. Sumption, E.W. Collings, and P.N. Barnes, "AC loss in striped (filamentary) YBCO coated conductors leading to designs for high frequencies and field-sweep amplitudes," Supercond. Sci. Tech. **18**, 122 (2005).

APPENDIX 2: WORKSHOP PARTICIPANTS

Workshop on Basic Research Needs for Superconductivity

Washington National Sheraton
Arlington, Virginia
May 8-10, 2006

Workshop Chair

John L. Sarrao, Los Alamos National Laboratory

Workshop Co-Chair

Wai-Kwong Kwok, Argonne National Laboratory

Panel Chairs

Ivan Bozovic, Brookhaven National Laboratory
David Christen, Oak Ridge National Laboratory
Leonardo Civale, Los Alamos National Laboratory
J.C. Davis, Cornell University
Igor Mazin, Naval Research Laboratory

Pre-workshop Briefing Presenter

James Daley, U. S. Department of Energy- Office of Electricity Delivery and Energy Reliability

Plenary Session Speakers

Paul Chu, University of Houston
George Crabtree, Argonne National Laboratory
James Daley, U.S. Department of Energy
Alex Malozemoff, American Superconductor
Mike Norman, Argonne National Laboratory
Zhi-Xun Shen, Stanford University

Sub-Panel Chairs

Alexander Balatsky, Los Alamos National Laboratory
Mac Beasley, Stanford University
Leonardo Civale, Los Alamos National Laboratory
Edward W. Collings, Ohio State University
Ted Geballe, Stanford University
Allen Goldman, University of Minnesota
Laura Greene, University of Illinois at Urbana-Champaign
Don Gubser, Naval Research Laboratory
David Larbalestier, University of Wisconsin at Madison
Joe Orenstein, Lawrence Berkeley National Laboratory
Warren Pickett, University of California at Davis
Jim Sauls, Northwestern University
Valerii Vinokour, Argonne National Laboratory

Sub-Panelists

Paul Arendt, Los Alamos National Laboratory (Writer)
Steve Ashworth, Los Alamos National Laboratory
Fedor Balakirev, Los Alamos National Laboratory

Paul Barnes, Air Force Research Laboratory (Writer)
Dimitri Basov, University of California at San Diego (Writer)
Alexey Bezryadin, University of Illinois at Urbana-Champaign (Writer)
Lev Boulaevskii, Los Alamos National Laboratory
Ivan Bozovic, Brookhaven National Laboratory
Yvan Bruynseraede, Katholieke Universiteit Leuven
Juan Carlos Campuzano, University of Illinois at Chicago
Paul Canfield, Ames Laboratory (Writer)
Praveen Chaudhari, Brookhaven National Laboratory
Paul Chu, University of Houston
Andrei Chubukov, University of Wisconsin at Madison
Lance Cooley, Brookhaven National Laboratory
George Crabtree, Argonne National Laboratory
Vincent Crespi, Pennsylvania State University
Tom Deveraux, University of Waterloo
Judith Driscoll, University of Cambridge
Matthias Eschrig, Universität Karlsruhe
James Eckstein, University of Illinois at Urbana-Champaign
Ron Feenstra, Oak Ridge National Laboratory
Herbert Freyhardt, University of Goettingen
Paul Grant, W2AGZ Technologies
Rick Greene, University of Maryland
Martin Greven, Stanford University (Writer)
Alex Gurevich, University of Wisconsin at Madison (Writer)
Bill Halperin, Northwestern University
Robert Hawsey, Oak Ridge National Laboratory
Drew Hazelton, SuperPower, Inc.
Peter Hirschfeld, University of Florida
Terry Holesinger, Los Alamos National Laboratory
Boldizsar Janko, University of Notre Dame (Writer)
Peter Johnson, Brookhaven National Laboratory
Vladimir Kresin, Lawrence Berkeley National Laboratory
Vladimir Kogan, Ames Laboratory
Patrick Lee, MIT
Andrew Mackenzie, University of St. Andrews
Alex Malozemoff, American Superconductor
Dean Miller, Argonne National Laboratory
Herb Mook, Oak Ridge National Laboratory
Mike Norman, Argonne National Laboratory
Xavier Obradors, ICMAB – Barcelona, Spain
Cedomir Petrovic, Brookhaven National Laboratory (Writer)
Mohit Randeria, Ohio State University
John Rowell, Arizona State University (Writer)
John Sarrao, Los Alamos National Laboratory
George Sawatzky, University of British Columbia
Doug Scalapino, University of California at Santa Barbara
Richard Scallatar, University of California at Davis
John Schneider, American Electric Power
Ivan Schuller, University of California at San Diego (Writer)
Zhi-Xun Shen, Stanford University
Katsuya Shimizu, Osaka University

Yuh Shiohara, SRL-ISTEC
David Singh, Oak Ridge National Laboratory (Writer)
Mike Sumption, Ohio State University
Jim Thompson, University of Tennessee (Writer)
Joe Thompson, Los Alamos National Laboratory
John Tranquada, Brookhaven National Laboratory (Writer)
Shinichi Uchida, University of Tokyo
Xiaoxing Xi, Pennsylvania State University
Igor Zutic, University of Buffalo (Writer)

APPENDIX 3: WORKSHOP PROGRAM

Workshop on Basic Research Needs for Superconductivity

Washington National Sheraton
Arlington, Virginia
May 8-10, 2006

Monday, May 8, 2006	
7:15 AM	
7:30 AM	
7:45 AM	7:15a – 8:30a Badge & Workshop Package Pickup Continental Breakfast
8:00 AM	
8:15 AM	
8:30 AM	8:30a – 8:40a, Pat Dehmer, BES Welcome and Workshop Center
8:45 AM	8:40a – 8:55a, Workshop Chairs
9:00 AM	8:50a – 9:20a Paul Chu (Materials): "Novel Superconducting Materials for Science and Technology"
9:15 AM	
9:30 AM	9:20a – 9:50a Alex Malozemoff (Applications): "Electric Power Applications of Superconductors"
9:45 AM	
10:00 AM	8:30a – 12:00p Plenary Opening Session
10:15 AM	9:50a – 10:15a George Crabtree (Vortex): "Vortex Matter in Superconductors"
10:30 AM	
10:45 AM	10:15a – 10:35a Session Break
11:00 AM	
11:15 AM	10:35a – 11:00a Z-X Shen (Phenomena): "Photoemission Investigation of Superconductors – Achievement, Potential and Challenge"
11:30 AM	11:00a – 11:25a Mike Norman (Theory): "What We Don't Know about Superconductivity (But Would Like to Find Out)"
11:45 AM	11:25a – 11:40a Jim Daley "Technologies Program Overview and Basic Research Needs"
12:00 PM	11:40a – 12:00p Panel Chair Introduction (4x5 min)
12:15 PM	
12:30 PM	12:00n – 1:30p Lunch
12:45 PM	
1:00 PM	Galaxy Ballroom
1:15 PM	
1:30 PM	
1:45 PM	
2:00 PM	
2:15 PM	
2:30 PM	
2:45 PM	
3:00 PM	1:30p – 5:30p Breakout Session I
3:15 PM	Sub-panels 1-7 Speaker Presentations & Initial Discussion of PRDs
3:30 PM	Sub-panelists 8: 13 join sub- panels 1-7 (Secondary Assignments)
3:45 PM	
4:00 PM	
4:15 PM	
4:30 PM	
4:45 PM	
5:00 PM	
5:15 PM	
5:30 PM	
5:45 PM	
6:00 PM	
6:15 PM	
6:30 PM	6:00p – 7:30p Dinner
6:45 PM	
7:00 PM	Galaxy Ballroom
7:15 PM	
7:30 PM	
7:45 PM	7:30p – 9:30p Breakout Session II
8:00 PM	
8:15 PM	Sub-panels 1-7 Refinement of 3 – 5 PRDs for session
8:30 PM	
8:45 PM	
9:00 PM	
9:15 PM	

Tuesday, May 9, 2006	
7:15 AM	7:15a – 8:00a
7:30 AM	Continental Breakfast
7:45 AM	
8:00 AM	8:00a – 12:00 noon Breakout Session III Sub-panels 8-12 Speaker Presentations & Initial Discussion of PRDs
8:15 AM	Sub-panel 8a – Theory of superconductor interface phenomena (Theory) Chair: Jim Sauls Mezzanine 2
8:30 AM	Sub-panel 8b – Necessals superconductors (Materials) Chair: Allen Goldman Mezzanine 2
8:45 AM	Sub-panel 9 Superconductor properties: theory to apps. (Theory) Chair: Valerii Vinokour Concourse 1
9:00 AM	Sub-panel 10 – Making superconductors useful (Applications) Chair: Mac Beasley East 1
9:15 AM	Sub-panel 11 – Energy considerations of superconductors (Applications) Chair: Edward Collings Concourse 2
9:30 AM	Sub-panel 12 – Future utilization and functionality (Applications) Chair: Don Gubser East 2
9:45 AM	Sub-panels 1-7 Join sub-panels 8-12 (Secondary Assignments)
10:00 AM	Breakout Session III Speaker Presentations & Initial Discussion of PRDs
10:15 AM	Sub-panel 8a – Theory of superconductor interface phenomena (Theory) Chair: Jim Sauls Mezzanine 2
10:30 AM	Sub-panel 8b – Necessals superconductors (Materials) Chair: Allen Goldman Mezzanine 2
10:45 AM	Sub-panel 9 Superconductor properties: theory to apps. (Theory) Chair: Valerii Vinokour Concourse 1
11:00 AM	Sub-panel 10 – Making superconductors useful (Applications) Chair: Mac Beasley East 1
11:15 AM	Sub-panel 11 – Energy considerations of superconductors (Applications) Chair: Edward Collings Concourse 2
11:30 AM	Sub-panel 12 – Future utilization and functionality (Applications) Chair: Don Gubser East 2
11:45 AM	Sub-panels 1-7 Join sub-panels 8-12 (Secondary Assignments)
12:00 PM	12:00n – 1:00p
12:15 PM	Lunch
12:30 PM	Galaxy Ballroom
12:45 PM	
1:00 PM	1:00p – 3:30p Breakout Session (IV)
1:15 PM	Sub-panel 8a Theory of superconductor interface phenomena Mezzanine 2
1:30 PM	Sub-panel 9 – Superconductor properties: theory to applications Concourse 1
1:45 PM	Sub-panel 10 – Making superconductors useful East 1
2:00 PM	Sub-panel 11 – Energy considerations of superconductors Concourse 2
2:15 PM	Sub-panel 12 – Future utilization and functionality East 2
2:30 PM	Panel A: Materials (Sub-panels 1, 2, 6b) Chair: Ivan Bozovic South Ballroom Front
2:45 PM	Panel B: Phenomena (Sub-panels 3-6) Chair: JC Semins and Leonardo Cvale South Ballroom Back
3:00 PM	Panel C: Theory (Sub-panels 6, 7) Chair: Igor Mazin Mezzanine 3
3:15 PM	
3:30 PM	3:30p – 4:00p Session Break
3:45 PM	
4:00 PM	4:00p – 6:00p Preliminary Presentations From panel chairs South Ballroom
4:15 PM	4:00 pm – 4:30 pm Bozovic - Materials
4:30 PM	4:30 pm – 5:00 pm Davis - Phenomena
4:45 PM	5:00 pm – 5:30 pm Mazin - Theory
5:00 PM	5:30 pm – 6:00 pm Christen - Applications
5:15 PM	
5:30 PM	
5:45 PM	
6:00 PM	6:00p – 7:30p Dinner
6:15 PM	
6:30 PM	
6:45 PM	
7:00 PM	
7:15 PM	
7:30 PM	7:30p – 9:30p Breakout Session V Sub-panels 8-12 Panel Meetings: Preliminary Organization of Panel PRDs
7:45 PM	Panel C: Theory (Sub-panels 6a, 9) Chair: Igor Mazin Mezzanine 2
8:00 PM	Panel D: Applications (Sub-panels 10-12) Chair: David Christen Mezzanine 3
8:15 PM	
8:30 PM	
8:45 PM	
9:00 PM	
9:15 PM	

	Wednesday, May 10, 2006	Thursday, May 11, 2006
7:15 AM	7:15a – 8:00a Continental Breakfast	7:15a – 8:00a Continental Breakfast
7:30 AM		
7:45 AM		
8:00 AM	8:00a – 12:00n Breakout Session VI Preparation for Closing Plenary Talks	8:00a – 12:00n Workshop Report Writing Workshop Chairs, Panel/sub-panel Chairs, and Writers Draft of Final Report and description of 2-4 PRDs per panel
8:15 AM		
8:30 AM		
8:45 AM		
9:00 AM		
9:15 AM		
9:30 AM		
9:45 AM		
10:00 AM		
10:15 AM		
10:30 AM		
10:45 AM		
11:00 AM		
11:15 AM		
11:30 AM		
11:45 AM		
12:00 PM	12:00n – 1:00p Lunch Galaxy Ballroom	12:00n – 1:00p Lunch Concourse
12:15 PM		
12:30 PM		
12:45 PM		
1:00 PM	1:00p – 3:30p Closing Session PANELS PRESENT PRDs South Ballroom	1:00p – 3:30p Workshop Report Writing Workshop Chairs, Panel/sub-panel Chairs, and Writers Finish all writing
1:15 PM		
1:30 PM		
1:45 PM		
2:00 PM		
2:15 PM		
2:30 PM		
2:45 PM		
3:00 PM	3:30p – 4:30p Reception Galaxy Ballroom Workshop Adjourns (4:30p)	
3:15 PM		
3:30 PM		
3:45 PM		
4:00 PM		
4:15 PM		
4:30 PM		
4:45 PM		
5:00 PM		
5:15 PM		
5:30 PM		
5:45 PM		
6:00 PM		
6:15 PM		
6:30 PM		
6:45 PM		
7:00 PM		
7:15 PM		
7:30 PM		
7:45 PM		
8:00 PM		
8:15 PM		
8:30 PM		
8:45 PM		
9:00 PM		
9:15 PM		

DISCLAIMER

This report was prepared as an account of a workshop sponsored by an agency of the United States Government. Neither the United States Government nor any agency thereof, nor any of their employees or officers, makes any warranty, express or implied, or assumes any legal liability or responsibility for the accuracy, completeness, or usefulness of any information, apparatus, product, or process disclosed, or represents that its use would not infringe privately owned rights. Reference herein to any specific commercial product, process, or service by trade name, trademark, manufacturer, or otherwise, does not necessarily constitute or imply its endorsement, recommendation, or favoring by the United States Government or any agency thereof. The views and opinions of document authors expressed herein do not necessarily state or reflect those of the United States Government or any agency thereof.



Publishing services provided
by Argonne National Laboratory.

